

TOP)A)K)U)S)T)I)K)

Installation Manual

Please read before starting installation
ISSUE 2023

Information on new Topakustik Installation Manual 2023

This installation manual replaces all previous installation documents. The information is valid for installers and designers of ceiling- and wall coverings. The ceiling systems are treated as complete kits, substructure and acoustic covering.

Validity – and field of application

This installation manual is valid as an application guideline and does not represent a complete reference to existing standards or codes. Descriptions and details refer only to Topakustik products. It defines dimensions, limiting dimensions and design requirements for ceilings in interior areas. The user is obliged to maintain all due project related requirements as well as respective valid standard requirements.

This installation manual however - has no validity for the following applications:

- Accessible ceilings and their supporting structure
- Ceilings with specific requirements regarding corrosion behaviour
- Ceilings with dynamic and/or static load effects (swimmingpools, underground stations etc.)

Additional Loads:

The installation of additional loads is not foreseen in the systems documented here. The substructure is to be attached by appropriate means to structural components. Additional loads (lights, ventilation elements among other things) are to be attached separately whenever possible. The substructure as well as the top layer must not be walked on. For special applications, a reinforcement of the system construction is feasible for additional loads. The direct consultation of Topakustik AG is a mandatory pre-requisite for this.

The determination of corresponding additional loads and their definition in writing shall be done by the customer. For all types of installations, the regulations documented here are to be observed.

All details and technical information in this manual or other publications referring to Topakustik products are based on test results obtained under typical conditions or general technical rules.

Mechanical installation:

Topakustik-systems must be mechanically installed for the wall and ceiling according to the following system specifications in this installation manual.

Higher strength can be achieved if adhesive is also used for the connection between the acoustic material and the substructure. We recommend using the installation paste adhesive Jowapur 685.32 from the company Jowat. Other adhesive systems should be checked by the installer prior to installation.

Obligation

We urgently recommend you to read and respect the yellow pages p. 4 and 5 before installation.

Technical changes without prior notification in the sense of further development are reserved at any time.

Content	Topakustik Classic	Topakustik Perfo	Topakustik Micro	Topakustik Custom	Page
Important information (yellow page) for installation	✓	✓	✓	✓	4/5
Cleaning instructions	✓	✓	✓	✓	6
Cut-outs for wall connections	✓	✓	✓	✓	7
Cut-outs with router or shadow joint cutter	✓	✓	✓	✓	8
PLANKS					
Veneered planks, sorting, transverse joints, humid rooms	✓	✓	✓		9
Installation of planks with nail gut on transverse blocking	✓	✓	✓		10
Start- / end planks, as well as sport hall walls	✓				11
SC1 System (screw clip, CD profile)	✓	✓	✓		12/13
SC2 System (screw clip, slat)	✓	✓	✓		14
W1 Ceiling system (staple gun, slatted grid)	✓	(✓)	(✓)		15
W2 Ceiling system (staple gun, counter grid)	✓	(✓)	(✓)		16
W3 Wall system (staple gun, horizontal)	✓	(✓)	(✓)		17/18
W4 Wall system (staple gun, vertical)	✓	(✓)	(✓)		19/20
H1 Ceiling system (metal grid)	✓	✓	✓		21
H2 Ceiling system (metal grid)	✓	✓	✓		22
T1 Ceiling system (metal grid)	✓	✓	✓		23/24
H System (installation details)	✓	✓	✓		25
Access panel with rotary latch	✓	✓	✓		26
Access panel inserted	✓	✓	✓		27
H5 Wall system (metal grid, horizontal grooves)	✓	✓	✓		28/29
H6 Wall system (metal grid, vertical grooves)	✓	✓	✓		30/31
PANELS					
Sorting, joining, installation with nail gun	✓				32
X1 Ceiling system (staple gun, slatted grid)	✓				33
X2 Ceiling system (staple gun, counter grid)	✓				34
X3 Wall system (staple gun, horizontal)	✓				35
X4 Wall system (staple gun, vertical)	✓				36
CHS System	✓	✓	✓	✓	37-39
G1 System	✓	✓	✓	✓	40-42
G1/G2 System (longitudinal clip)	✓	✓	✓	✓	43
G2 System	✓	✓	✓	✓	44
S11 System	(✓)	✓	✓	✓	45-50
Sixty	✓	✓	✓	✓	51-54

Content	Topakustik Classic	Topakustik Perfo	Topakustik Micro	Topakustik Custom	Page
SL1 System		✓			55/56
SL2 System		✓			57/58
SL3 System		✓			59
EpM 1 System	✓	✓	✓	✓	60-62
EpM 2 System	✓	✓	✓	✓	63
EpM 3 System	✓	✓	✓	✓	64
FL1 System for ceiling (wood rabbet strip)	✓	✓	✓	✓	65
FL2 System for wall (wood rabbet strip)	✓	✓	✓	✓	66
Hat profile installations (wall)	✓	✓	✓	✓	67
Notes					68

Please read carefully before starting installation!

Storage at building site

- Topakustik elements in general have to be protected against humidity and have to be stored absolutely dry.
- Store elements lying flat on dry wood or pallets.
- Protect elements on all sides with plastic for against humidity.
- Please observe especially in new building the dampness coming from the concrete floor!

Acclimatise

- The elements are to be acclimatised inside the installation room 3-4 days before installation. Take care that all elements are exposed evenly to the room air.

Veneered elements made of natural wood

- Veneered elements are made of naturally grown wood and are inherently subject-related variations in color and structure. Even veneers within a tribe may have some differences. Therefore, these elements have to be sorted harmoniously on their structure and color before mounting.

Stiffeners

Removable ceiling covers with Topakustik panels must be stiffened on the back in order to ensure flatness of the elements over time.

This for the following reason:

- The bending caused by the panel own weight can be «still acceptable» at installation.
- The bending increases over time caused by fatigue of the material.
- Different climatic conditions in the installation room and in cavities lead to an uneven shrinking and swelling and deformation of the panels is promoted.

Cleaning

- With damp cloth and mild cleaning detergent
- Eraser for pencil lines
- Vacuum clean dusty areas and acoustic elements. Please ensure that only vacuum cleaner heads with a soft brush are used (to prevent scratches).

Liability

Please observe in general the specific characteristic of the wood material. Damages or faults, which have an impact on the processing or are caused by an overloading of the Topakustik-elements, exclude claims against us.

Complaints

All complaints are to be announced immediately after delivery and before start of installation by mail.

Further development

Technical changes as well as further developments are reserved.

Shrinkage and swelling (Expansion and Contraction)

In the standard design, the Topakustik-elements are made from MDF (medium density fibreboard). These panels are processed with a moisture content of 8-10%.

According to Standard DIN 68750/66754 resp. SIA 164/1 wood material shall be installed as follows:

- Air moisture	min. 35%	-	max. 60%
- Room temperature	min. 18° C	-	max. 30° C
= absolute air moisture	5.5 g/m ³		18 g/m ³
= resulting wood moisture of	7%		10.5%

Balanced climate

Considering these standards one has to expect a material-dilatation of 1.5 mm in 1000 mm (10.5% - 7% = 3.5% x 0.04% Swelling measure per 1% change).

Therefore Topakustik elements shall be separated with gaps of 3-6 mm corresponding to the element size. Separating the single elements by less than 3-6 mm can lead to:

- an increasing room moisture = closing of gaps and the elements can deform concave or convex
- an sinking room moisture = the gaps become wider

Rule of thumb: The installation shall occur under a balanced room climate how as it is to be expected during operational phase.

Topakustik planks are fully jointed systematically in width. Installation at high humidity can lead to a slight opening of the plank joints under dry conditions. In this case the planks have to be separated by 0.5 mm. For swimming pools the planks can be equipped with a special dilatation profile in the factory.

The installation under too dry conditions (winter) can lead to a slight deformation (concave/convex) of the planks when reaching high (probably normal) air moisture. The climatic conditions during installation must correspond to the conditions of subsequent use.

Production Tolerances

Planks: The Topakustik plank is delivered with a industrial clean angular cut.
The length tolerance is +/- 2 mm on the total length. If requested, the planks can be trimmed to fixed measure (Production tolerance +/- 0.25 mm per m¹, only recommended for plank length up to approx. 2 m > material dilatations)

Panels: Topakustik panels are produced accurately on computer controlled machines in the factory (Production tolerance +/- 0.25 mm per m¹).

The Topakustik-elements leave the production with above listed (small) measure tolerances. Depending on the type, the surface is increased two to three times by grooving and perforation of the Topakustik-elements. Topakustik reacts to changing room humidity at installation site very fast with changes in measures (> shrinkage and swelling) (>acclimatisation) P. 4

Instructions for cleaning Topakustik wall and ceiling cladding

Thanks to high-quality surfaces, paints and lacquers, the look and feel of our products are maintained at a high level throughout the entire service life. Nonetheless, if installed products need to be renovated or repainted after several years, we recommend testing the adhesion and the compatibility of the materials used on a reference area (Topakustik Micro and Custom cannot be lacquered or painted).

Vacuum clean dusty areas, grooves and drill holes or blow them clear with a little pressure. Please ensure that only vacuum cleaner heads with a soft brush are used (to prevent scratches).

Remove pencil marks with a soft rubber.

Clean the areas with a mild glass or surface cleaner. Apply cleaner evenly onto a cloth or kitchen paper and leave to take effect to prevent wet areas. Clean lengthwise / in the direction of the veneers.

For stubborn dirt, clean with mild, diluted soapy water (e.g. curd soap). Afterwards, wipe with a damp cloth and then dry.

Cleaning agent or water must never be sprayed directly onto the panels because moisture penetration into the holes would damage the panels.

No abrasive cleaning agents such as cellulose thinner, acetone, etc. may be used.

Machining

Drill holes

- Drill with applied stencil
- When drilling into installed ceiling, fix stencil with pins into the grooves
- For Topakustik types with fine ribs, tape down the visible surfaces and drill carefully so that the ribs do not break. (Use test piece)



Pic. 1

Cut-outs before installation

- Using a jig saw from the reverse side of the element delivers a neat cut.

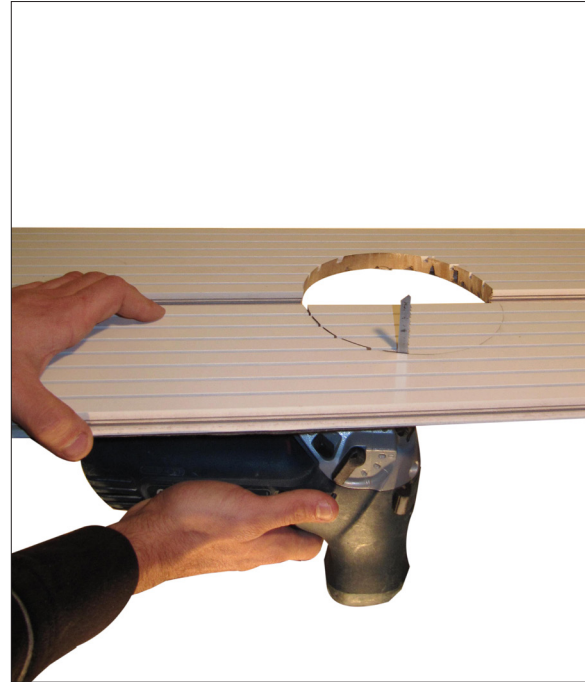

Pic. 2

Shadow joint alongside

- Plane the plank with hand plane to ready width



Pic. 3

Cut shadow joint (Pic. 4)

- Use sharp tool
- If necessary, drive (left) backwards
- Protect wall
- Pre-cut room corners with jig-saw
- Tears on the element edges can be avoided by using tape on the cutting edges



Pic. 4

Cut-out hand router

- Produce stencil to cut-out size e.g. MDF 10 mm.
- Take care when fixing the stencil to the groove, that it does not shift.
- Use router with thrust ring according to Pic. 5+6.
- Insert milling cutter \varnothing 10 mm.
- For types with fine ribs, stick covering tape onto cutting surface so that the ribs do not brake.
- When starting the cut-out, carefully position the milling cutter and start in a circular way to the right. (Pic. 6)

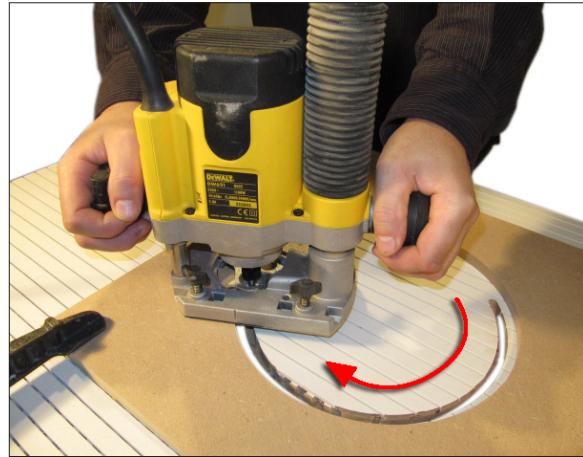

Pic. 5

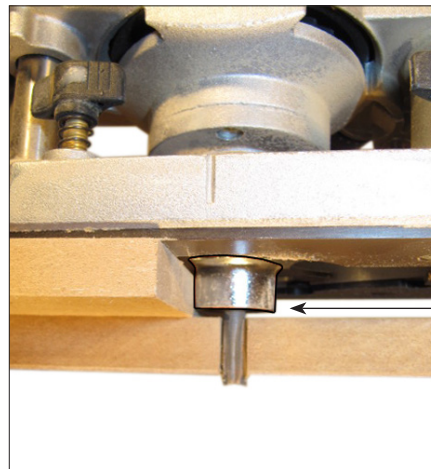

Thrust ring

Pic. 6

Angular cut-out with shadow joint cutter (Pic. 7)

- Produce stencil with cut-out size.
- Take care when fixing the stencil on the groove, that it does not shift.
- For types with fine ribs, stick covering tape onto cutting surface so that the ribs do not brake.
- When starting the cut-out, carefully position the milling cutter .
- Trim the cut-outs in the corners with a jig saw from the rear side.



Pic. 7

Veneered planks, sorting, transverse joints, TOP(A)K(U)S(T)I(K) humid rooms

Veneers

Topakustik-products are manufactured with selected veneers. Every veneer log has different natural features (growth and color, among other things).

We recommend a harmonic sorting of the Topakustik-elements before installation.

Laying options

Divide transverse laths in such a way that under every groove a lath is placed for fixation.

Parallel

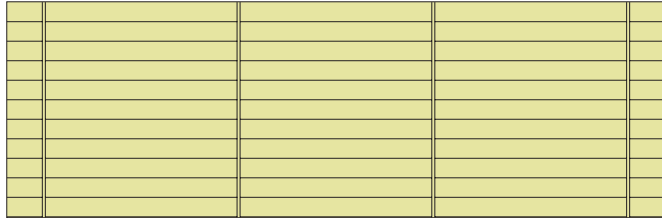

Pic. 1

English

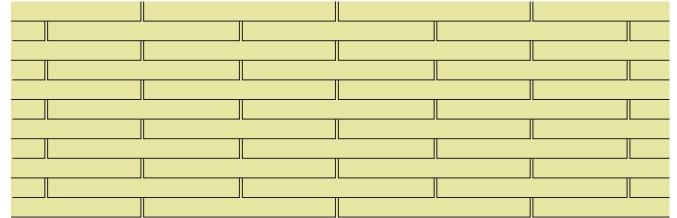

Pic. 2

Transverse grooves

Topakustik planks are available in various lengths up to 4m (see brochure). At transverse joints, we recommend allowing a gap of 3-4 mm to absorb any changes in the length due to room humidity fluctuations. Joints are to be furnished with a slat.

Parallel transverse grooves (Pic. 1 and 3)



Pic. 3

Topakustik planks have to be trimmed to length and installed in air-conditioned condition (see page 4 and 5) with router-or shadow joint cutter. Differences in measurements can occur before installation through change of room humidity at storage place or installation area.

Open wall connection (for humid rooms)

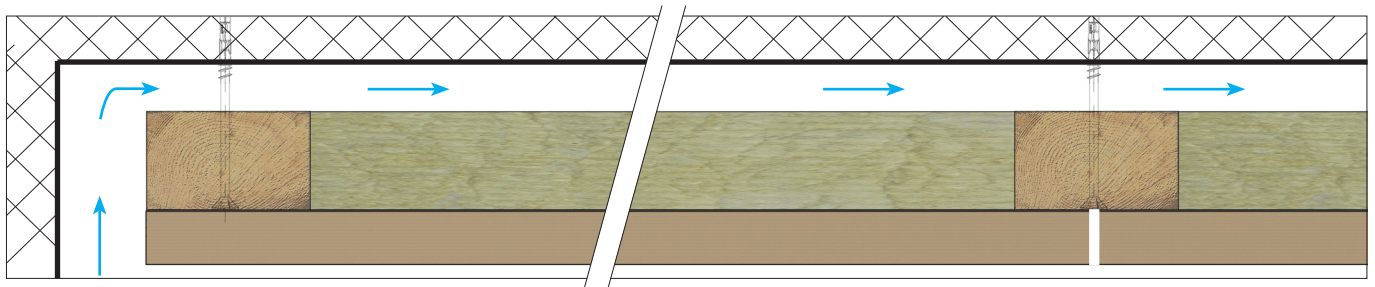

Pic. 4

Important for humid rooms

- Air ventilation required
- Use special carrier plate
- Use approved substructure
- Observe shrinkage und swelling when forming joints

When installing planks with difficult surfaces, we recommend to wear gloves when performing the installation (Pic. 5). 40 mm is necessary for clean rear ventilation (no formation of condensation), to ensure any possible condensation is able to dry. This also applies to the exterior walls of a building, which are cladded with Topakustik-products on the inside.



Pic. 5

Installation of planks with a nail gun on transverse blocking

Fixation

The tongue and groove joint is machined very precisely, therefore push the plank together only by hand. In case the groove does not close neatly, check the joint for obstructive staples or residues!

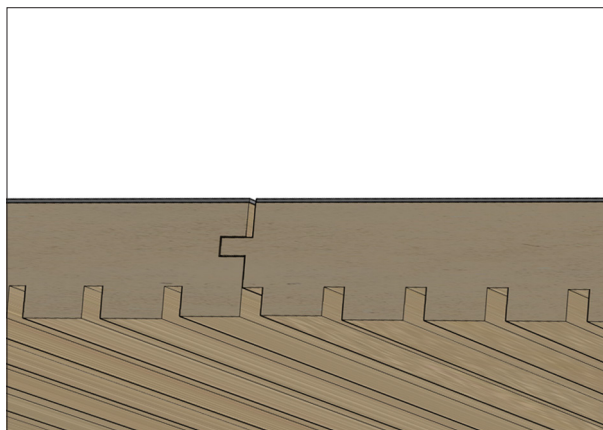

Pic. 6



Pic. 7

Information

Topakustik planks, width 128 mm, can be fixed by standard available devices according to pic. 8 - 13 on the groove side. Staple length min. 29 mm.

 Adjust air pressure correctly, i.e. countersink staples completely, without breaking through the groove profile according to Pic. 9.

For this installation use the standard foot according to Pic.11. The installation strength must be checked at the beginning of installation and at regular intervals.

Standard installation of Topakustik planks

Staples are shot into the groove.



Pic. 8



Pic. 10



Pic. 9

Installation through the grooves Topakustik Classic planks

The staples are placed into the outer grooves for start and end planks (Pic. 11 + 12). At high strain (wet rooms outside areas and RESAP®) the planks must be fixed in the middle additionally through the grooves.



Pic. 11



Pic. 12

Sports halls

When installing planks in sports halls, they have to be fixed, acc. to Pic. 8+10, in the groove and additionally in the middle of the plank with staples or according to Pic. 13 twice into the grooves. Staple length min. 32 mm



When installing through the grooves, the lower part of the «Special foot» is not guided on the side thus the striking pin is exposed to strong wear. This can mean that the staples are no longer completely countersunk i.e. replace the special foot. The staples have to be aligned on the solid part of the acoustic holes.



Pic. 13

Detail installation for RESAP®-planks

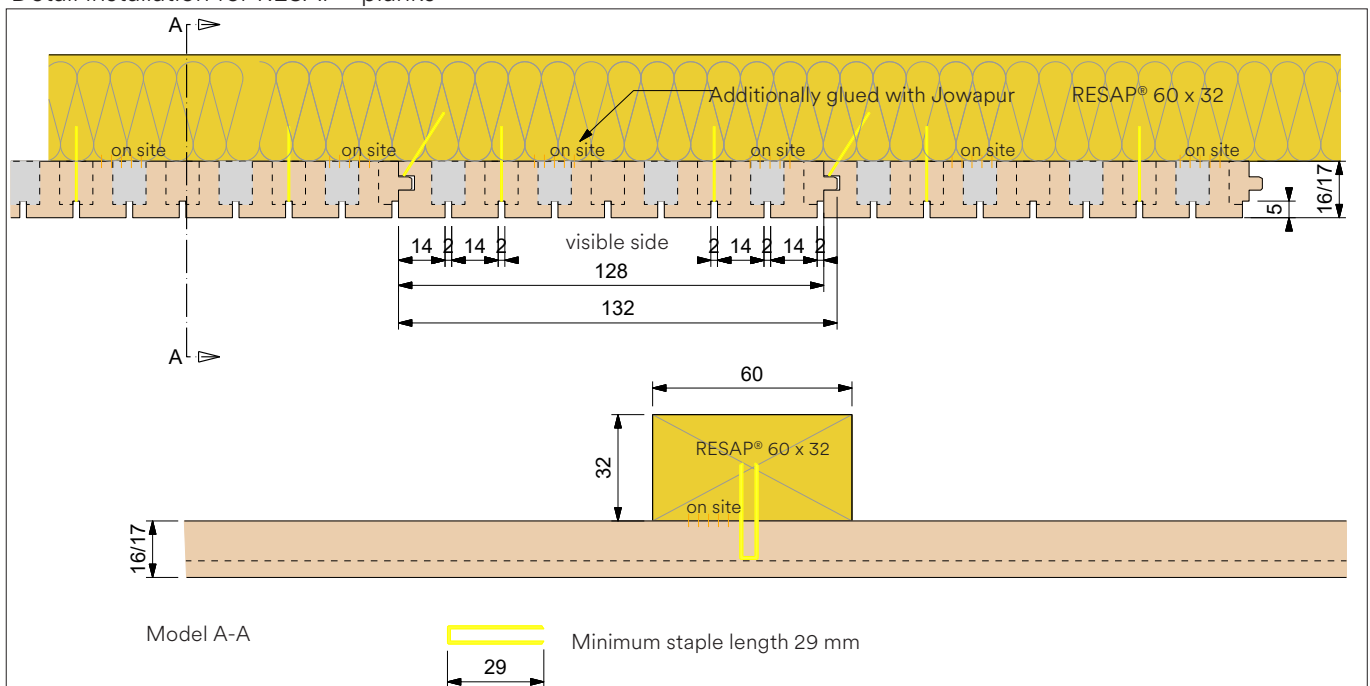

Pic. 14

RESAP® planks should be secured in place through the grooves and groove profile as according to Pic. 14. These must additionally be secured using PU glue.

*For PU glue, we recommend Jowapur 685.32; for other products, carry out an adhesion test first.

SC 1 System with metal substructure (on site)

Topakustik installation with planks using a screw clip is possible with metal (SC1) and wooden substructures (SC2).

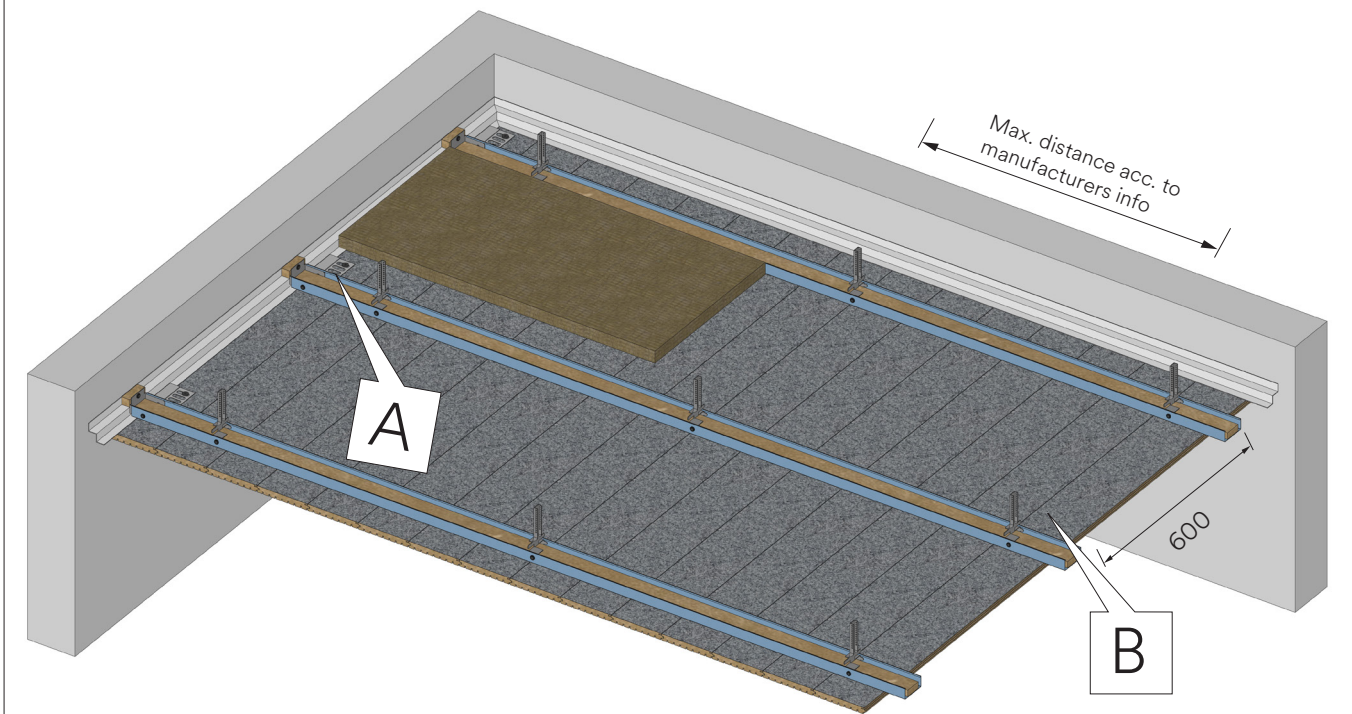

Distance between metal profiles 600 mm or less, according to manufacturer's recommendations. CD profile 60/27 for ceiling installation with wood or plaster inserts for attaching with screws.

Detail Installation Walls (Start)

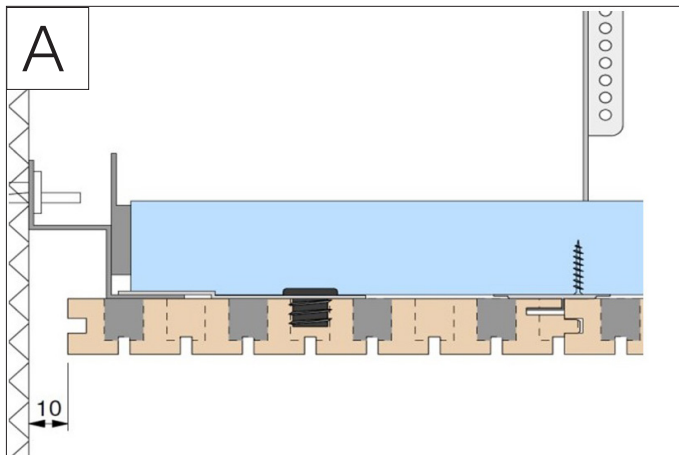

Detail Installation Walls (Start)

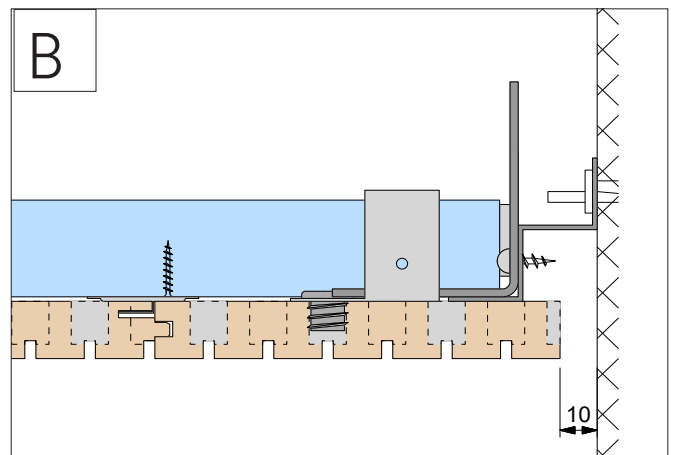

Installation of substructure grate acc. to manufacturer's recommendation. The system must be designed such that it is verified for the weight of the Topakustik material including insulation.

Detail Installation clip see Pic. 13 + 14

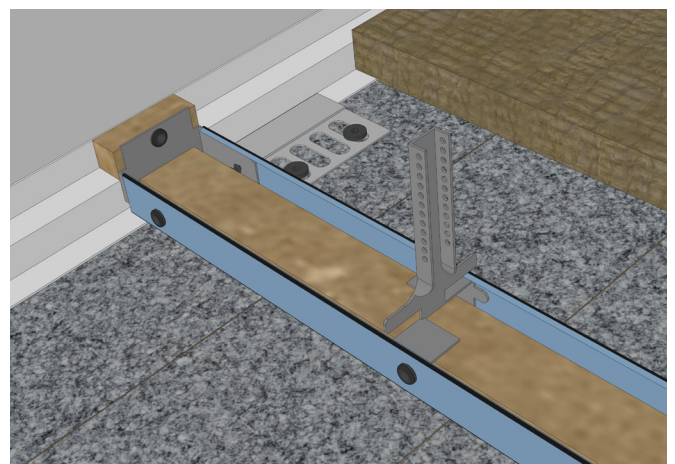
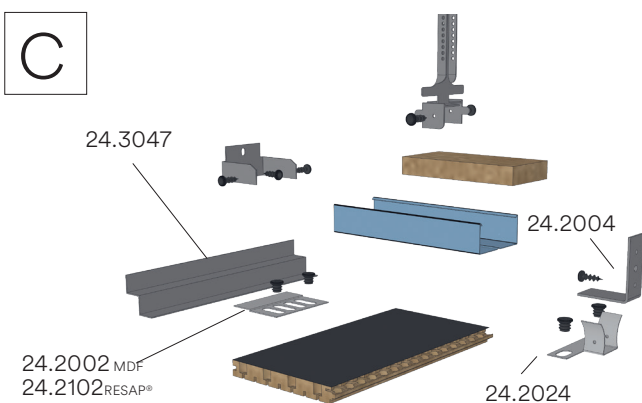

Details for Topakustik planks with screw clip and blind rivet:



Pic. 1

- Place the plank into the recommended position for fixation.
- Move the clip into the designed groove acc. to pic. 1.



Pic. 2

- Pre-drill the hole for the blind rivet, pic. 2



Pic. 3

- Place blind rivet into hand riveter, push into the pre-drilled hole and press down, pic. 3



Pic. 4

- Pin breaks away, clip is fixed, pic. 4

- Typical commercial blind rivet, pic. 5



Pic. 5

Details for Topakustik planks with screw clip and screw on wood slats.



Pic. 6

- Place the plank into the recommended position for fixation.
- Move the clip into the designed groove acc. to pic. 6



Pic. 7

- Place the screw clip in the desired position (push in fully) and fix in place with the wood screw provided. Pay attention to torque and do not tighten the screw excessively!

Screw clips are also available for RESAP® planks on request.

-> For the requirements on the slat substructure, see systems W1-W4.

-> Start and end planks can be bonded (bonding attempts necessary on site) or fixed in place with start/end planks clips as is the case with the SC1 system.

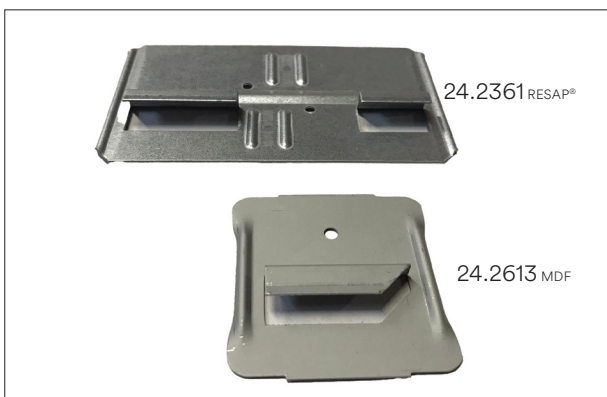

Pic. 28

W1 System with slatted grid

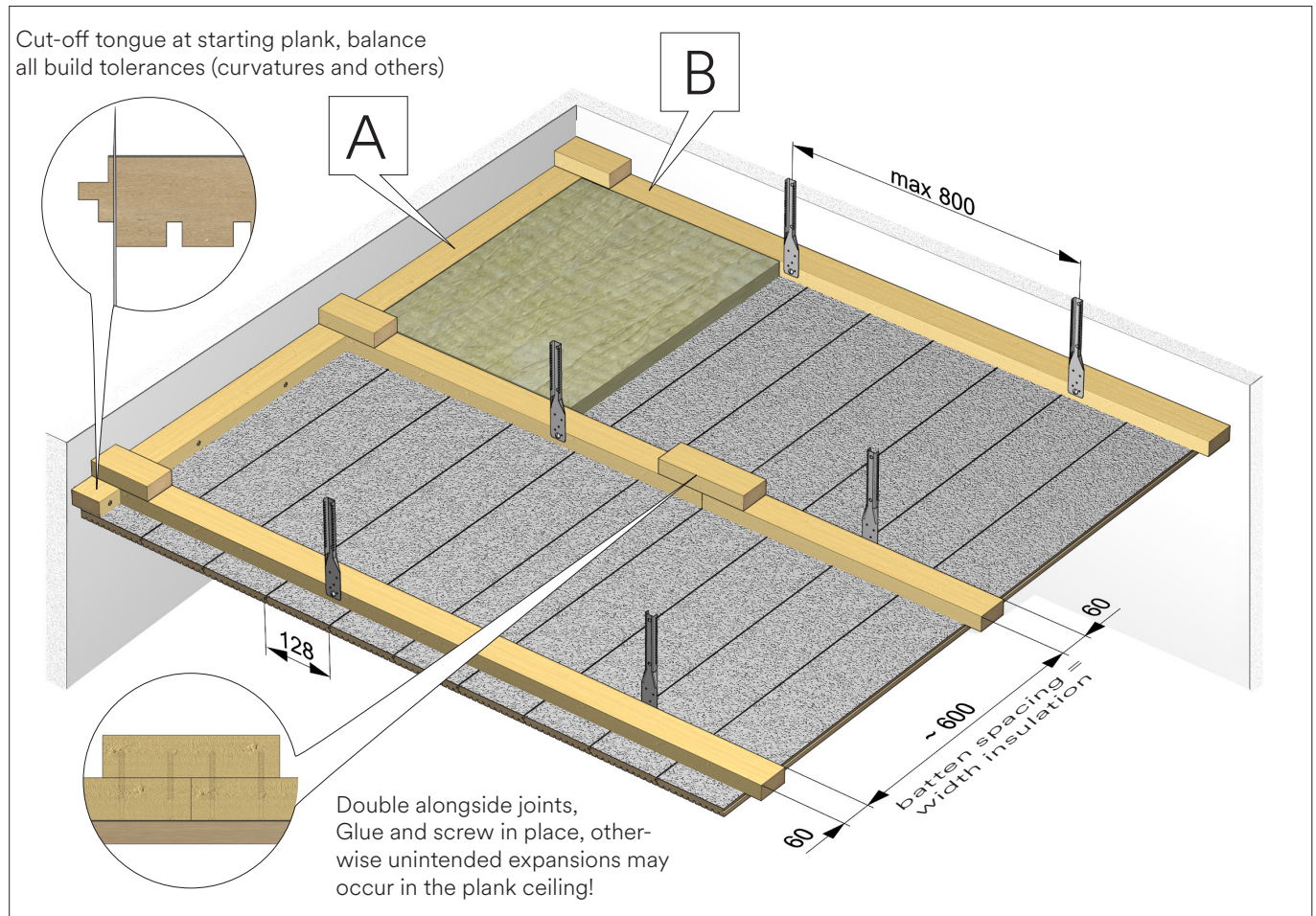

Wall connection

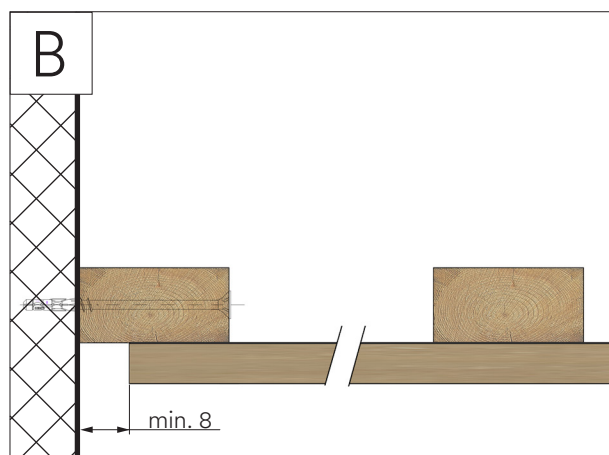
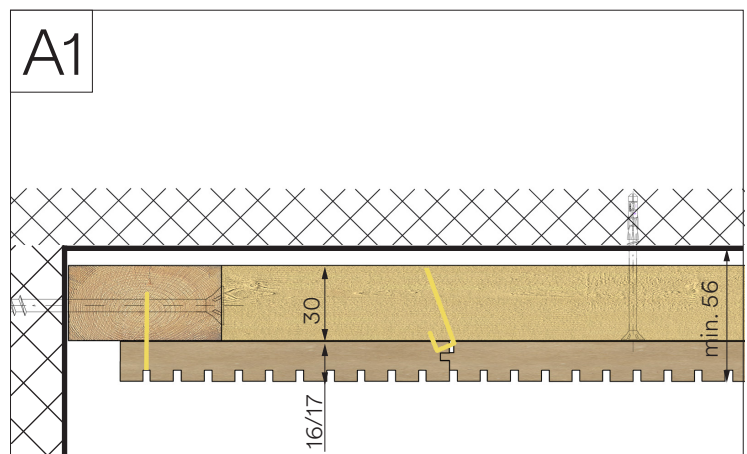
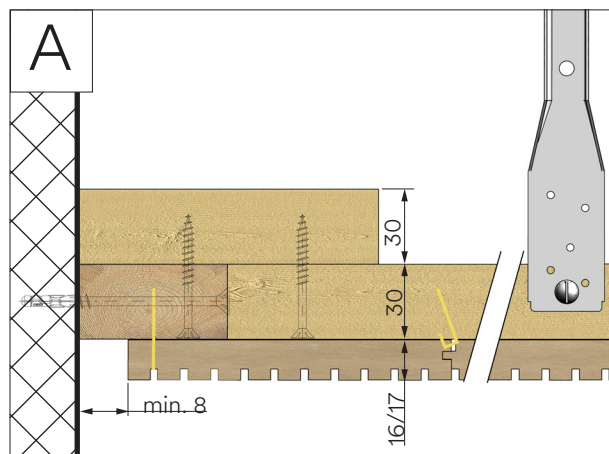

Installation on transverse wood lath
(wood moisture max. 10%)

Substructure:

Topakustik planks (without increased fire resistance requirement) are fixed on perfectly installed transverse wood battens made from planed, dry spruce tree laths 60/30 mm.

For installation of the wood battens with Nonius suspension (suspension positioned offset left and right of batten). Suspension distance 800 mm, Topakustik-element joints positioned on transverse battens.

Please observe shrink-/swell behaviour (see «Important Information» Page 4 and 5).

W2 System with counter grid

Cut-off tongue at starting planks balance all build tolerances (curvatures and others)

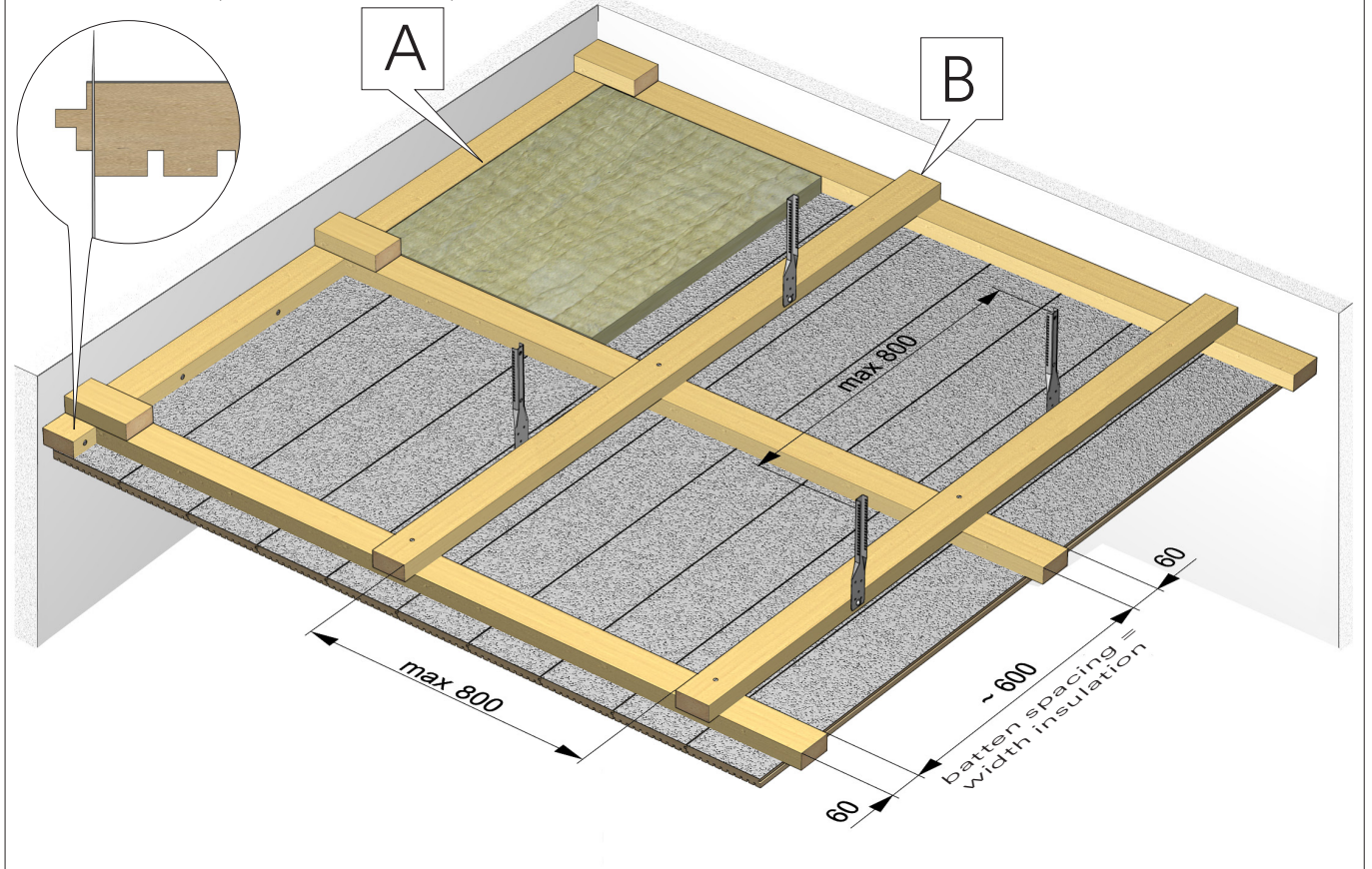

Wall connection

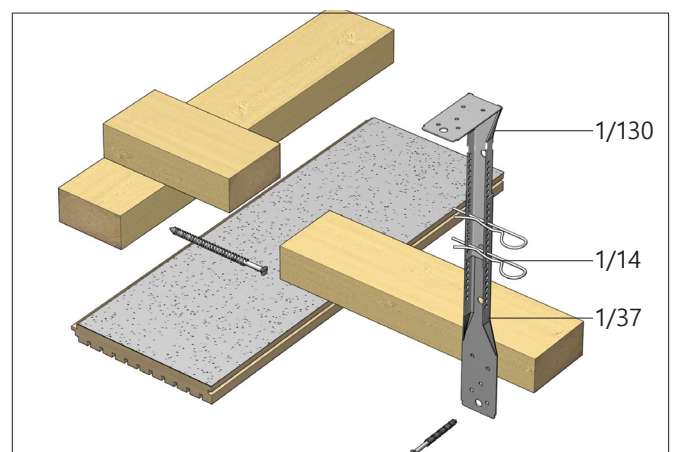
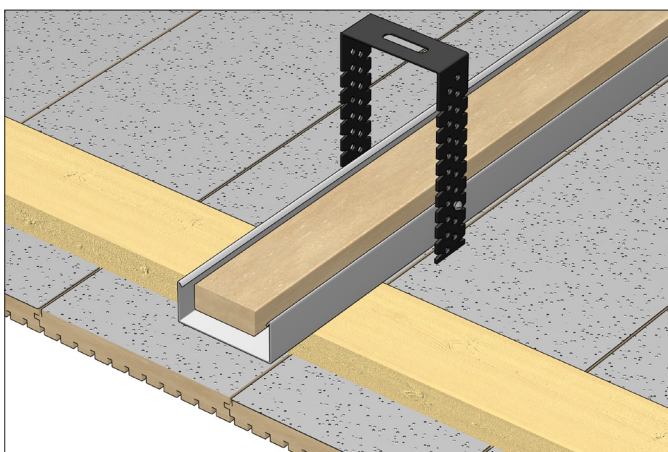
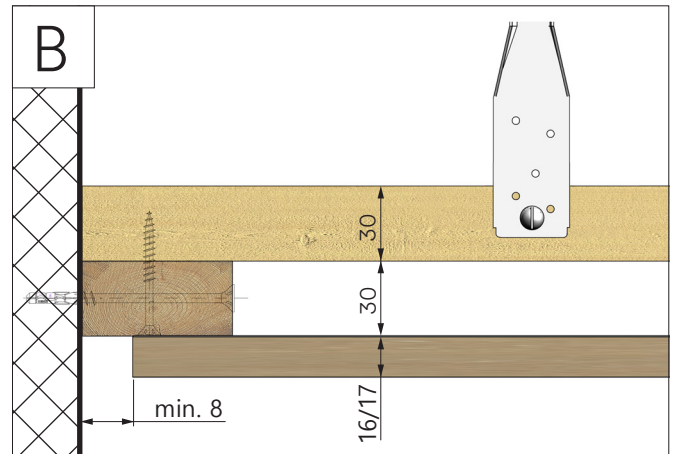
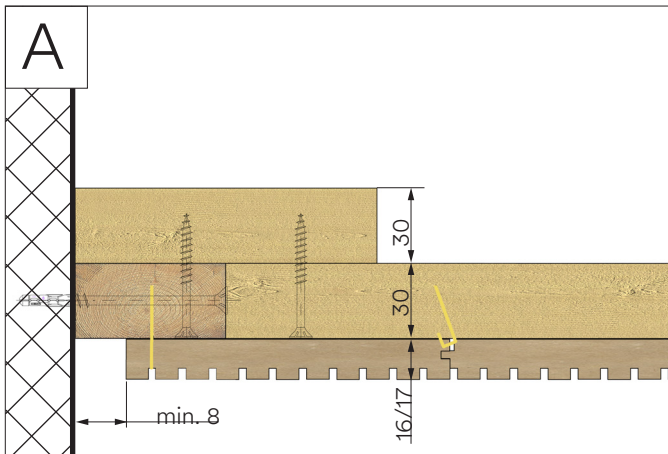

W3 System - Walls - Planks installed horizontally

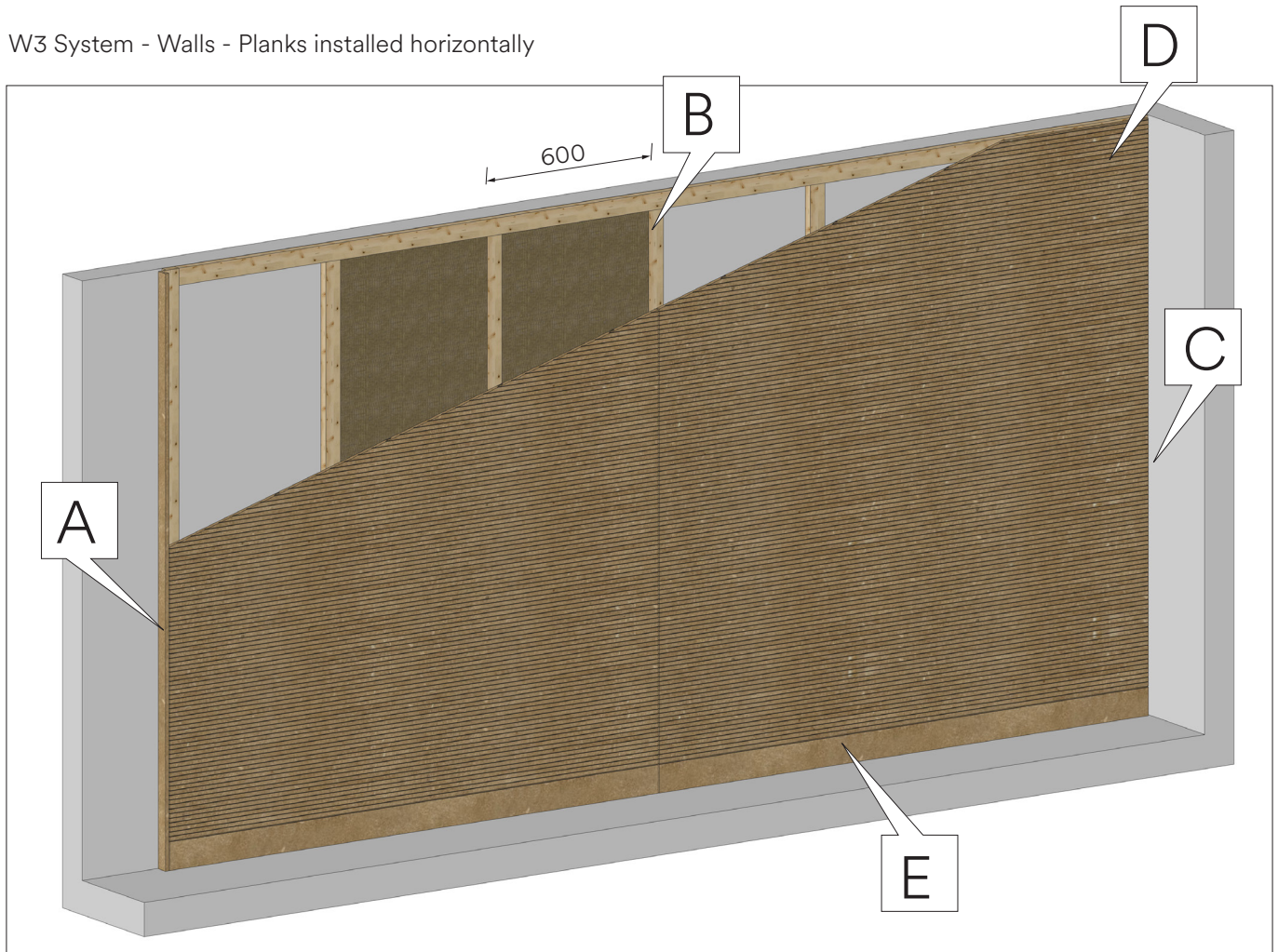

Edge ending and wall connection

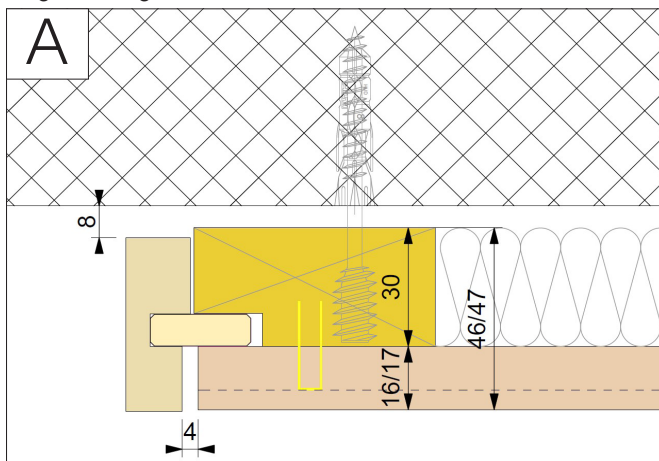

Installation on vertical wood grid
(wood moisture max. 10%)

Substructure:

Topakustik plank (without increased fire resistance requirement) are fixed on perfectly installed transverse wood battens made from planed, dry spruce wood slats 60/30 mm.

The slats should be placed down to the floor to support the weight of the wall. The slats are installed onto the bare wall using spacers/spacer bolts and according to verified fixing materials. Spacing of slats max. 600 mm, spacing of fixture points max. 800 mm. Transverse joints must be furnished with a slat (see B).

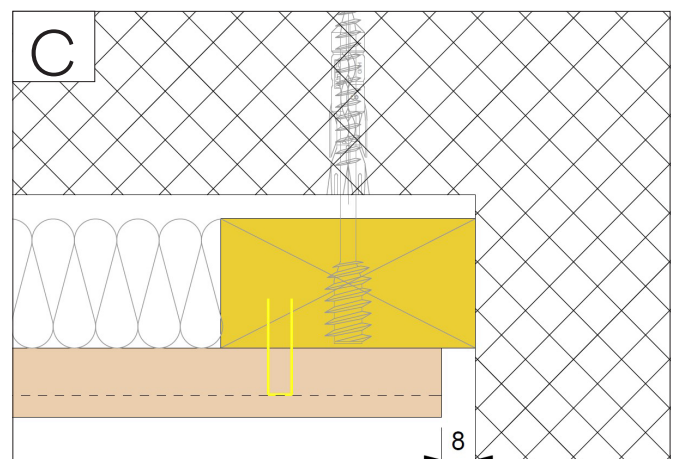
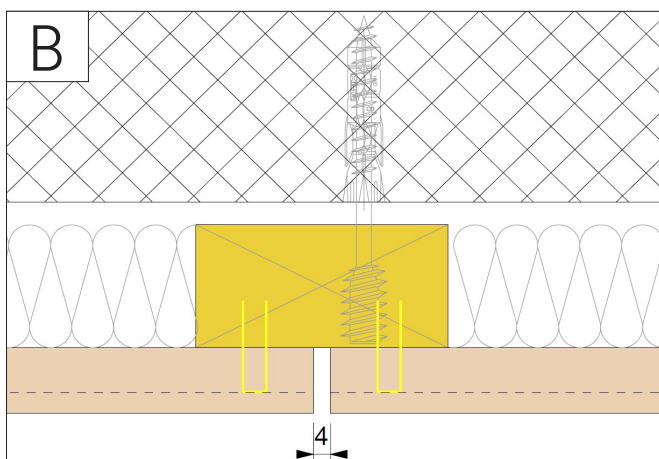

W3 System - Walls - Planks installed horizontally

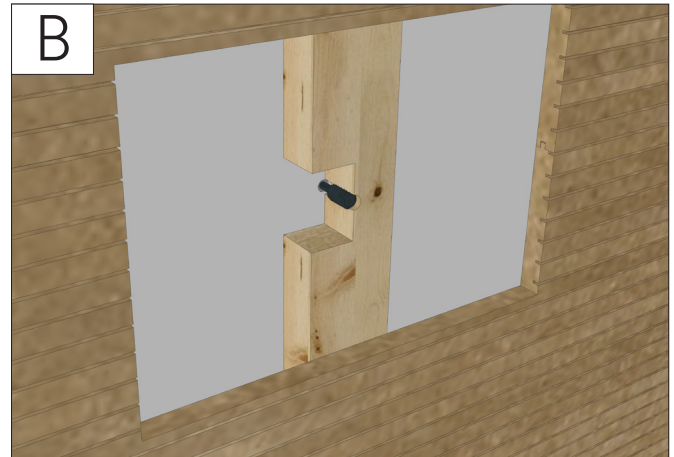
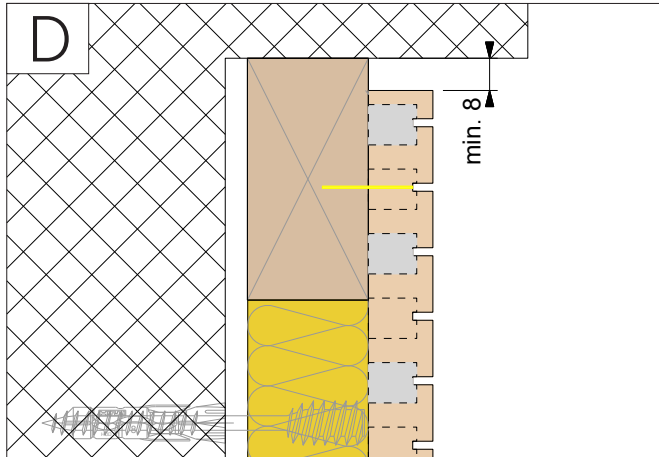

Substructure with spacer screw

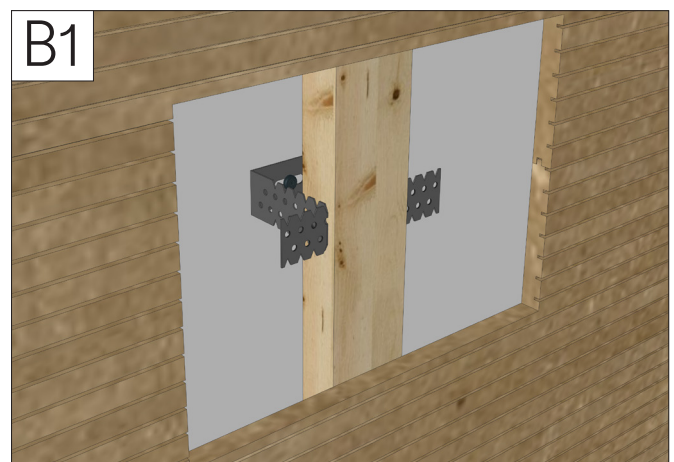
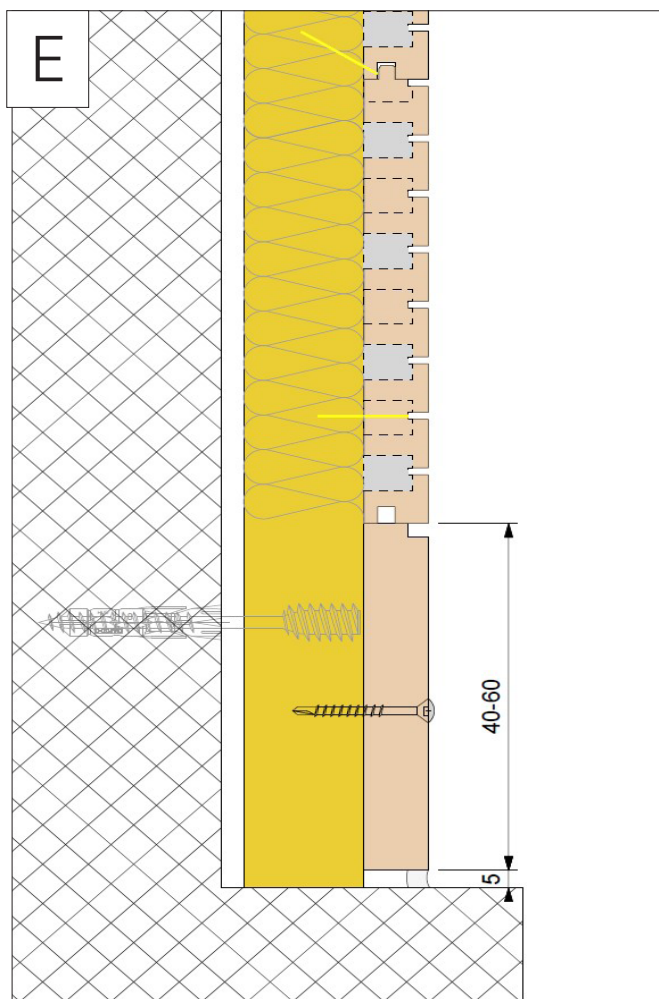

Substructure with spacer

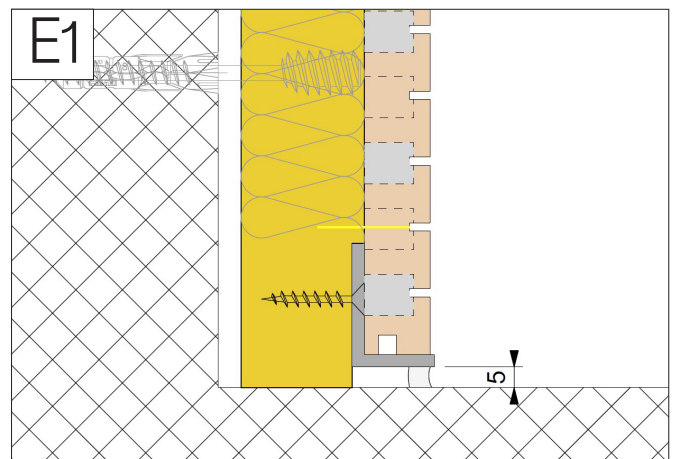

Planks supported at an angle

W4 System - Walls - Planks installed vertically

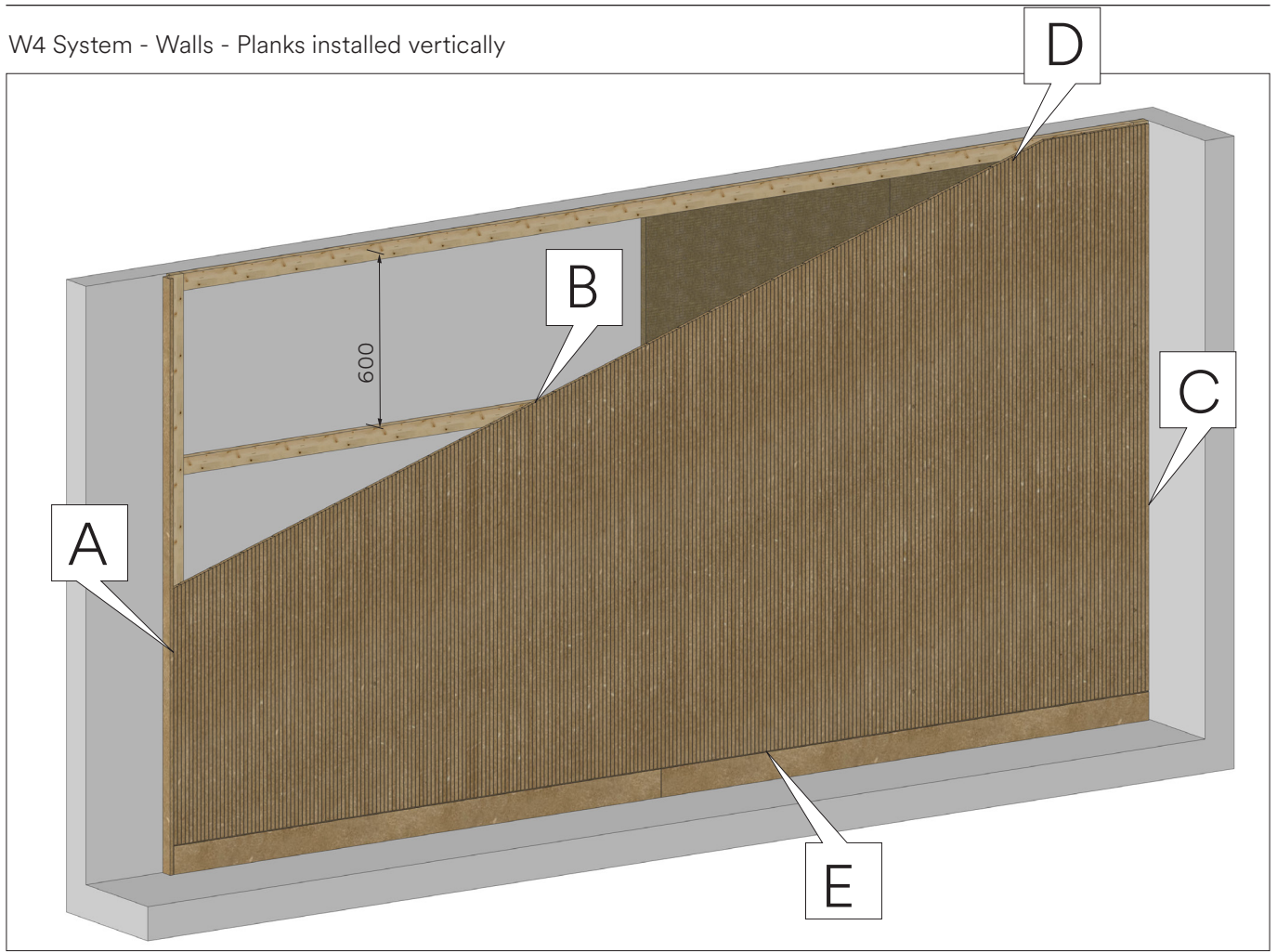

Edge ending and wall connection

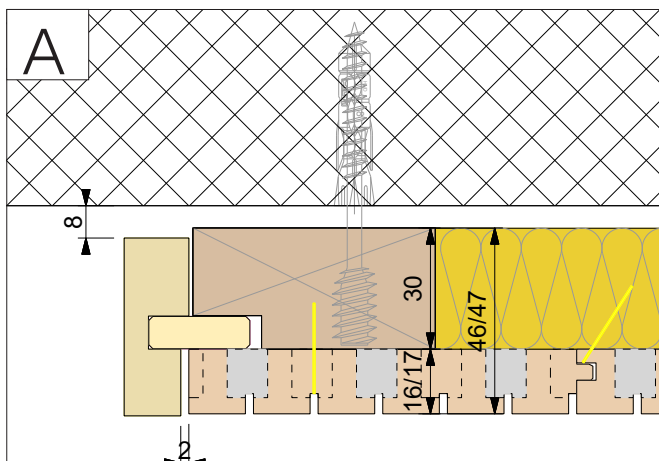

Installation on horizontal slats made from wood (wood moisture max. 10%)

Substructure:

Topakustik plank (without increased fire resistance requirement) are fixed on perfectly installed slats made from planed, dry spruce wood slats 60/30 mm.

The slats should be placed down to the floor (see E) to support the weight of the wall. The slats are installed onto the bare wall using spacer bolts or spacers and according to verified fixing materials. Spacing of slats max. 600 mm, spacing of fixture points max. 800 mm.

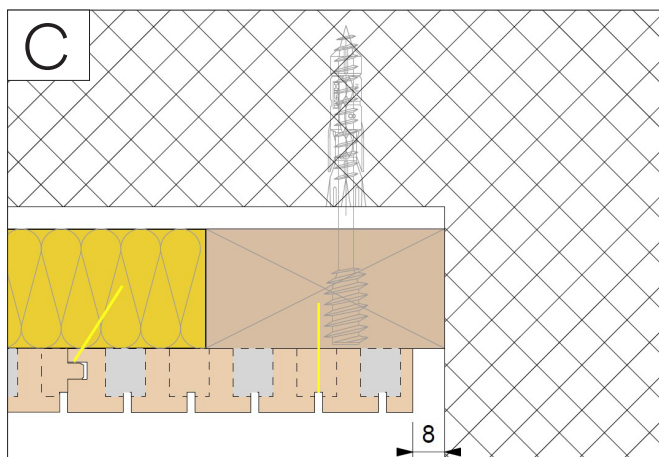

W4 System - Walls - Planks installed vertically

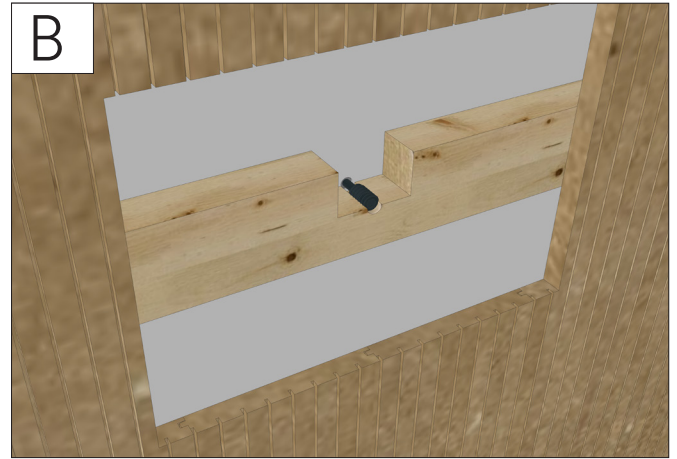
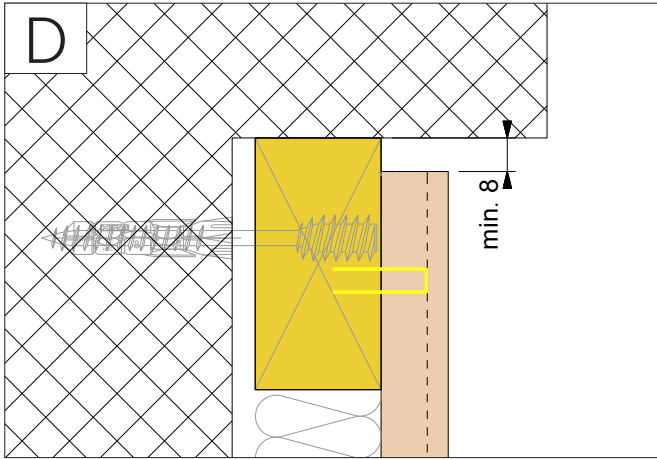

Substructure with spacer screw

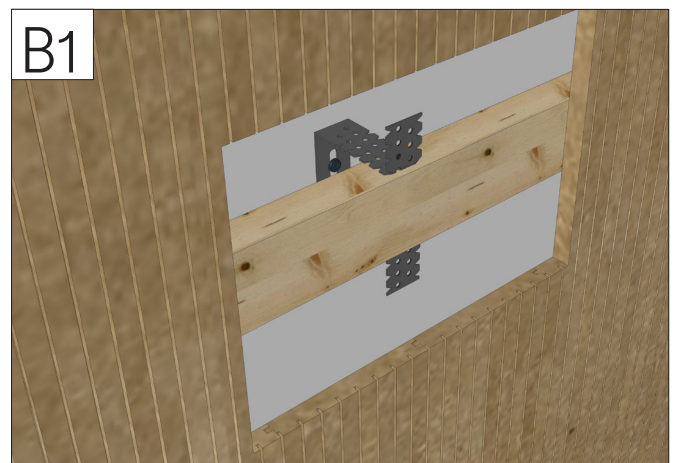
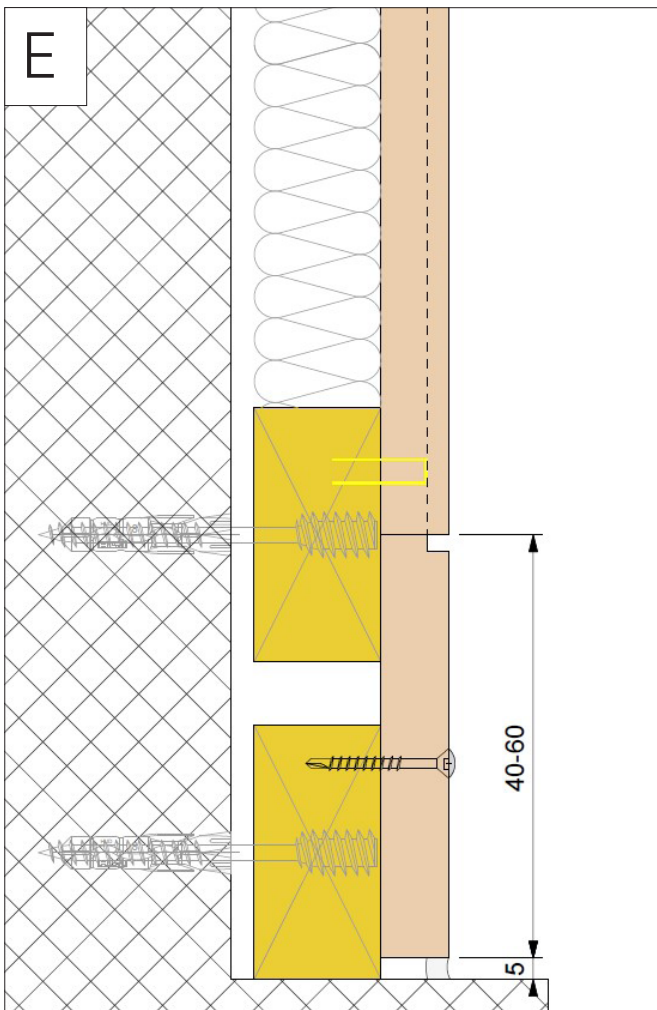

Substructure with spacer

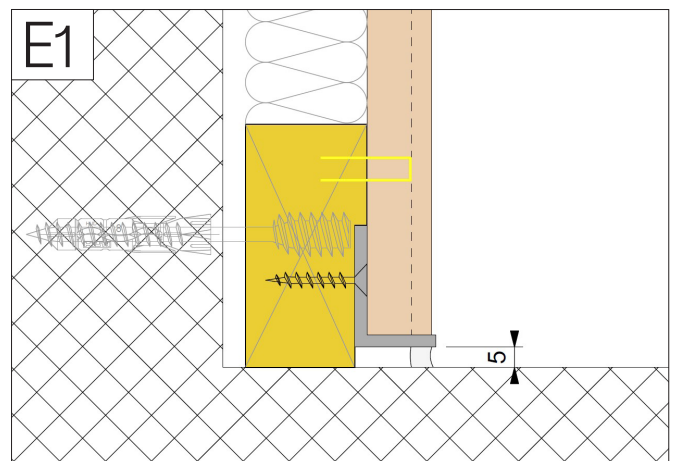

Planks supported at an angle

H1 System with metal gird

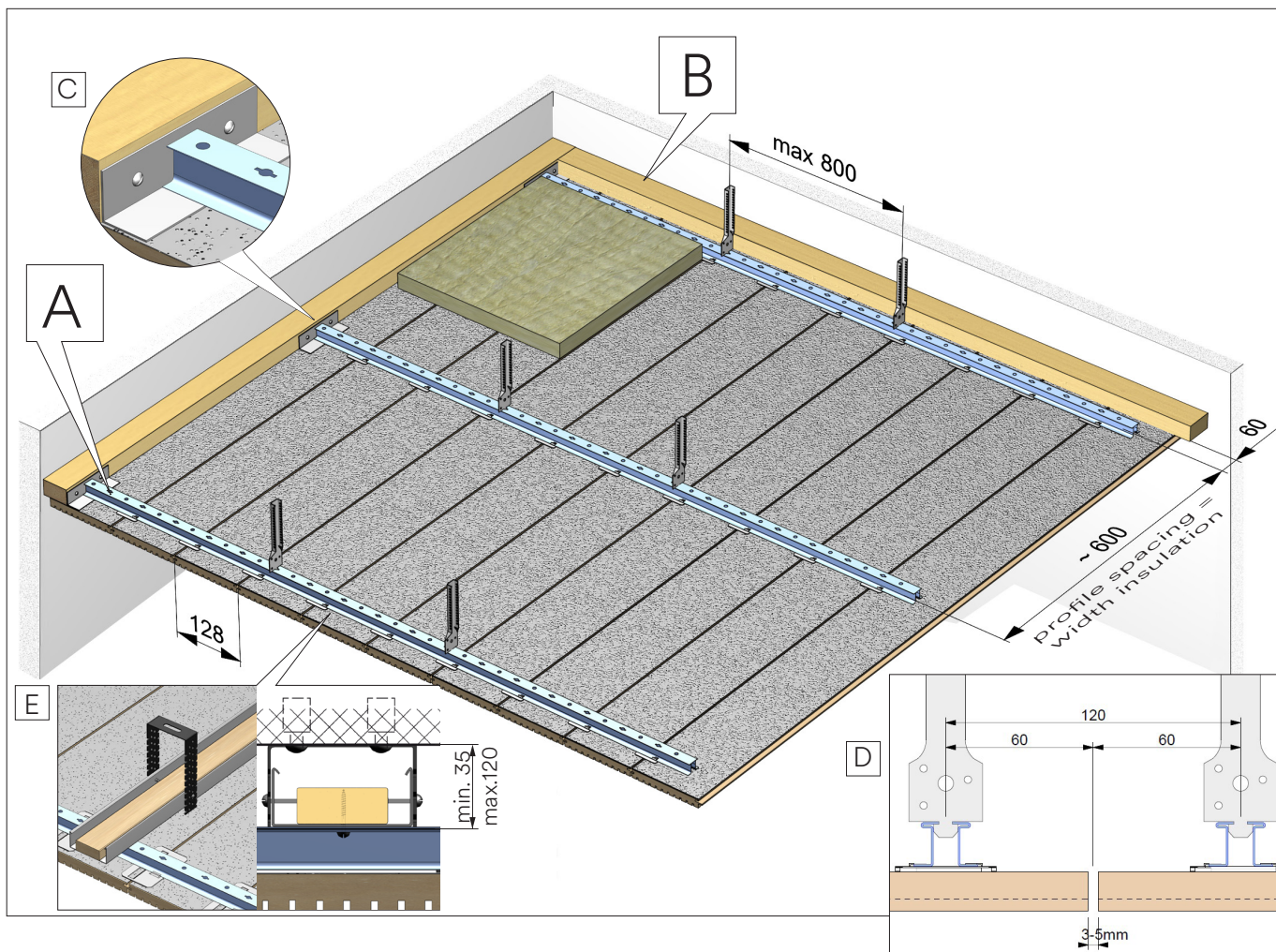

Wall connection

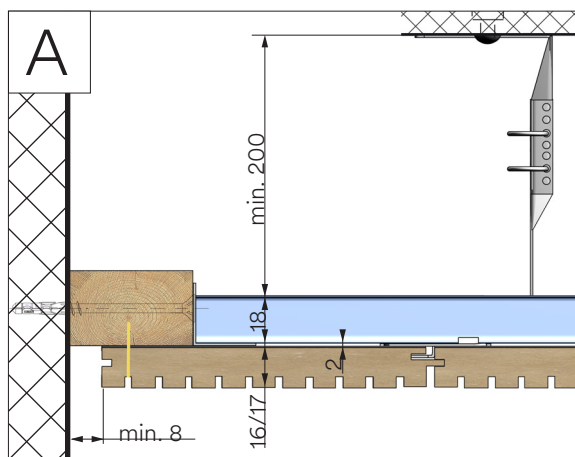

Installation with metal substructure and turning clips (H1 + H2 System)

Topakustik planks (Width 128 mm) are on the quick-build rails with rotary clips. Installation of the quick-build rails with Nonius suspensions, distance 800 mm. Please observe the shrink-/swell behaviour of the Topakustik plank. At every second plank row the rotary clip has to be fixed with a pop rivet to the quick build rivet. Nail start- and end plank to the wall connection rail.

The following listed accessories can be obtained from us.

- H-rails 18x26mm in 3000 mm length (24.2270)
- Nonius-subpart (PU = 100 pc) (24.2219)
- Connector to H-rails (PU= 20 pc) (24.2275)
- Rotary clips (Unit. = 100 pc) (24.2360 RESAP®, 24.2302 MDF)

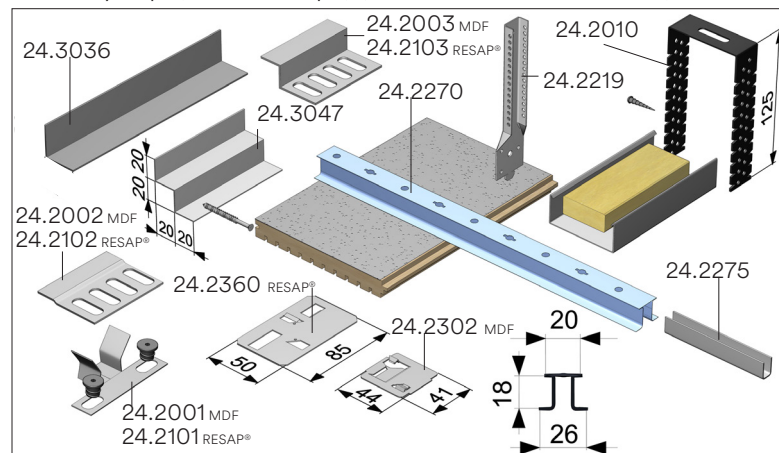
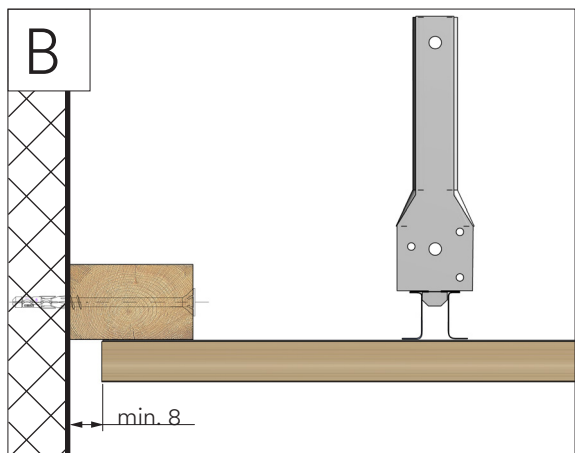

H2 System with metal grid

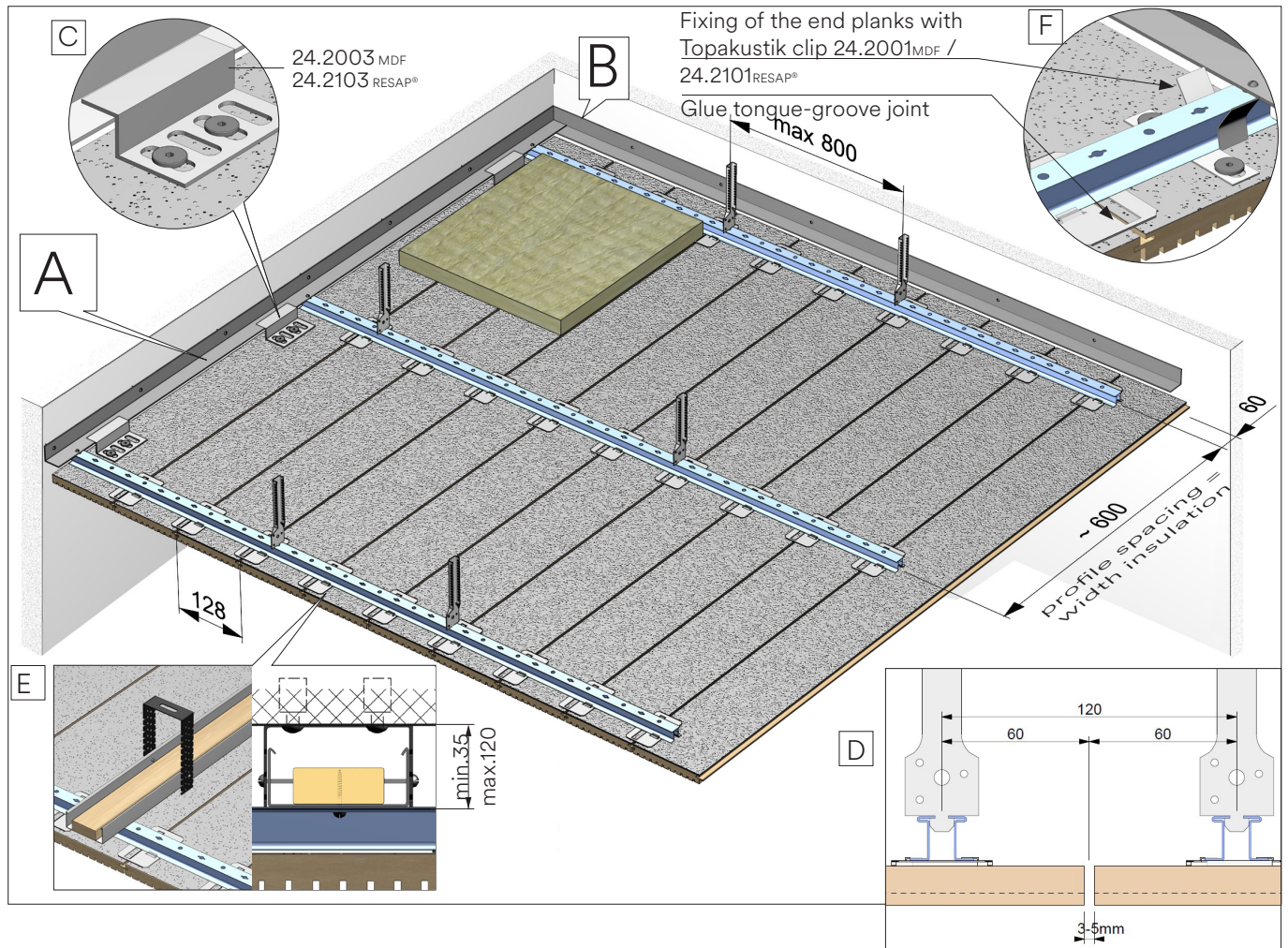

Wall connection

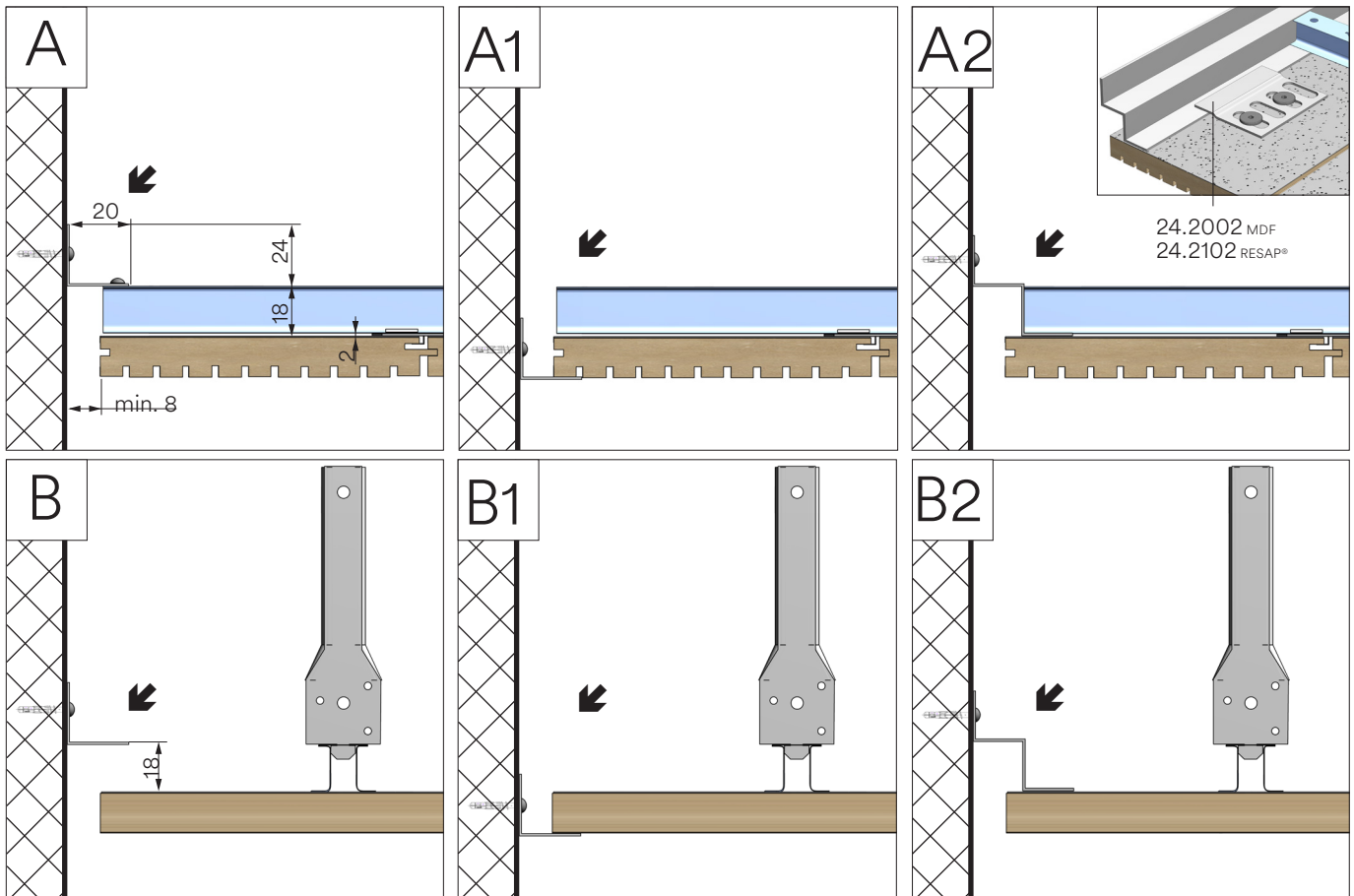

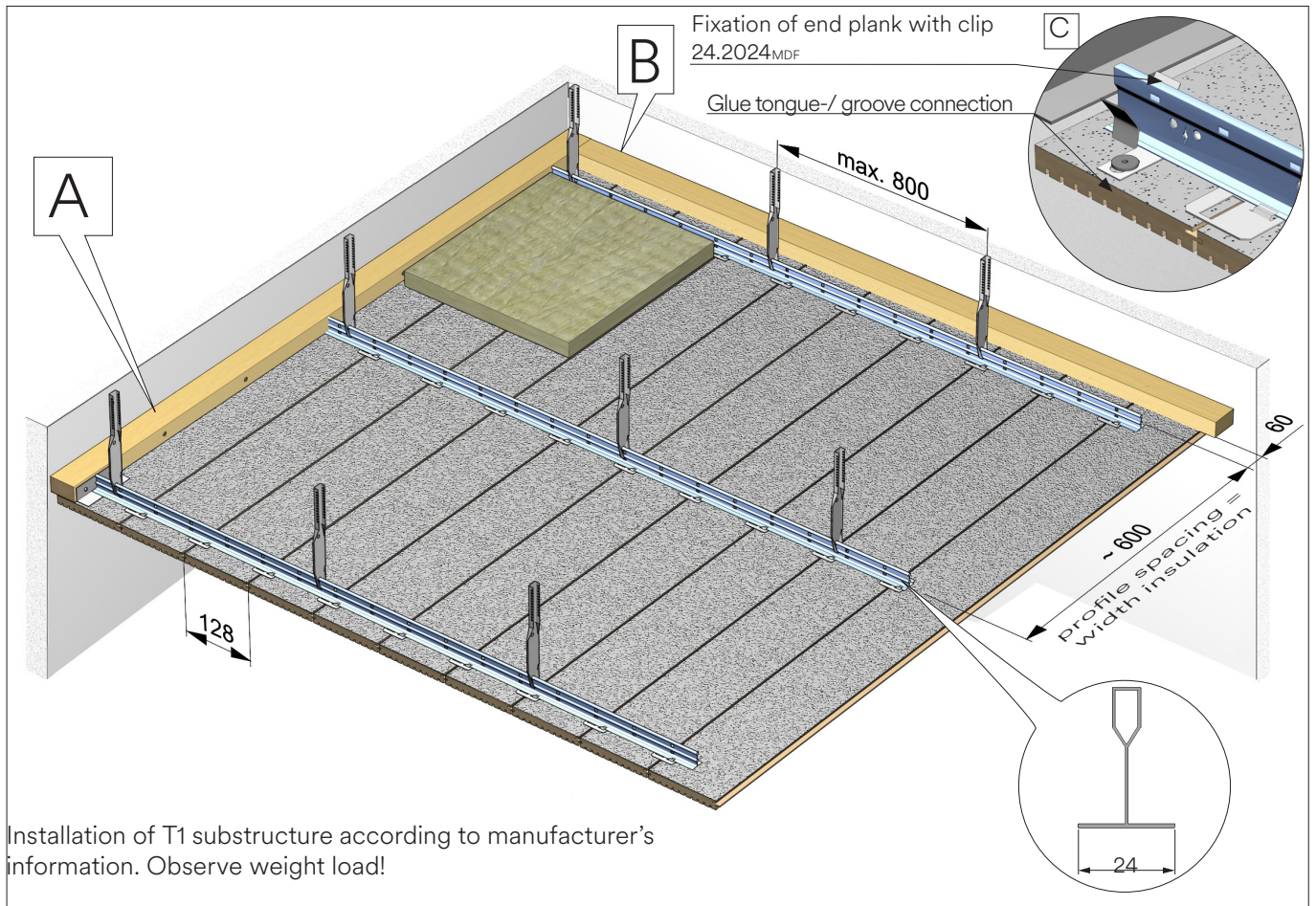

Wall connection

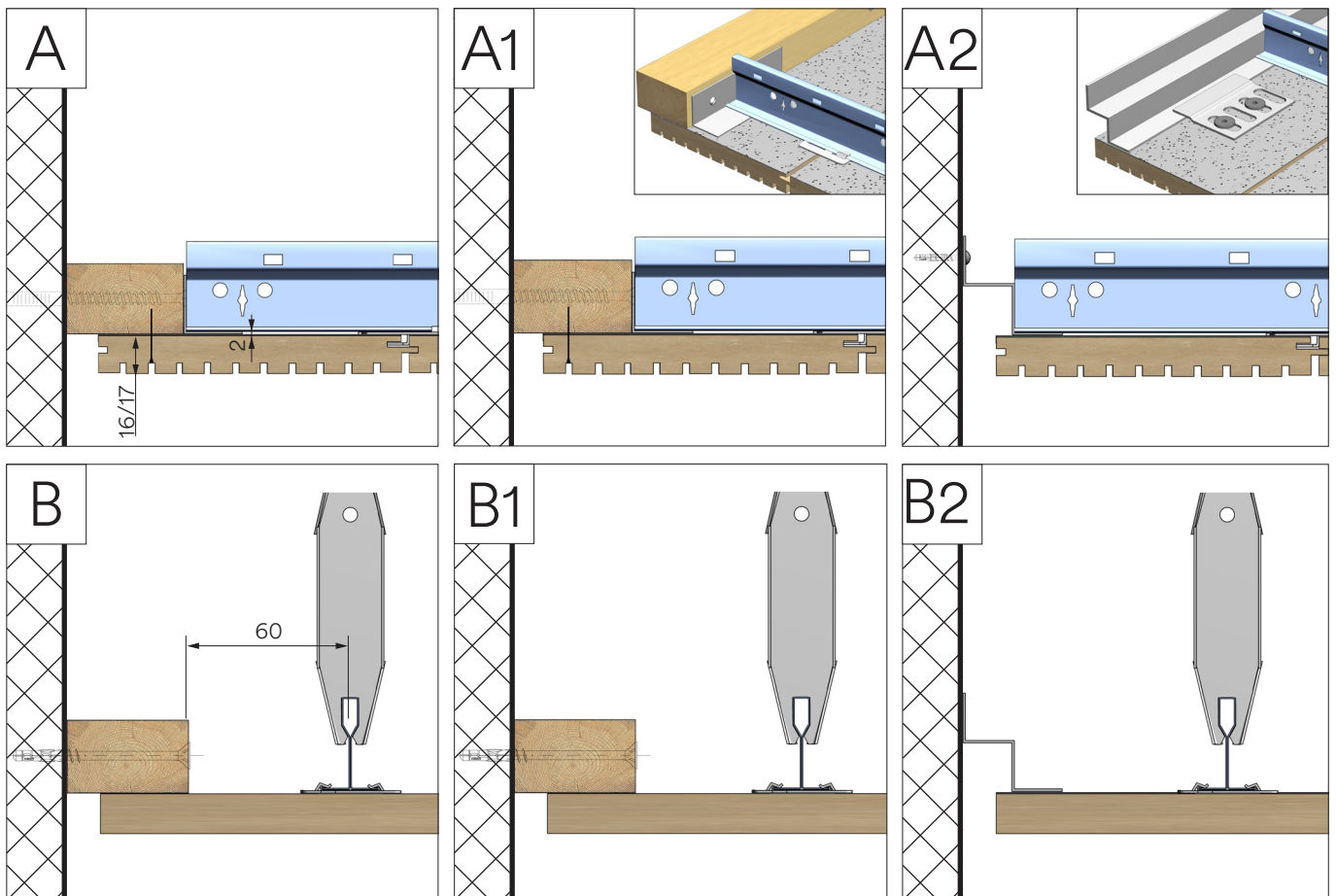

Installation clip for T1-System, only for MDF planks

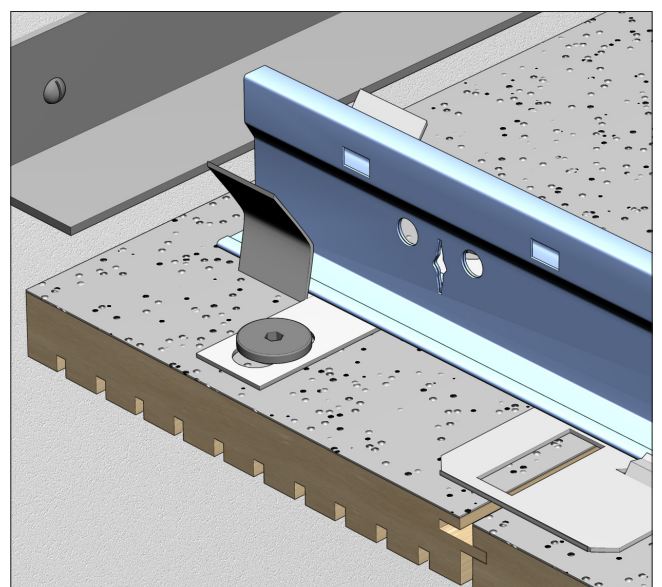
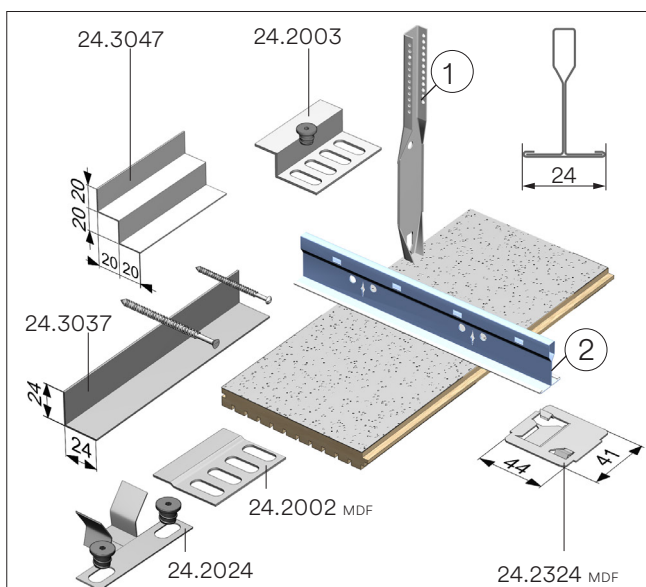
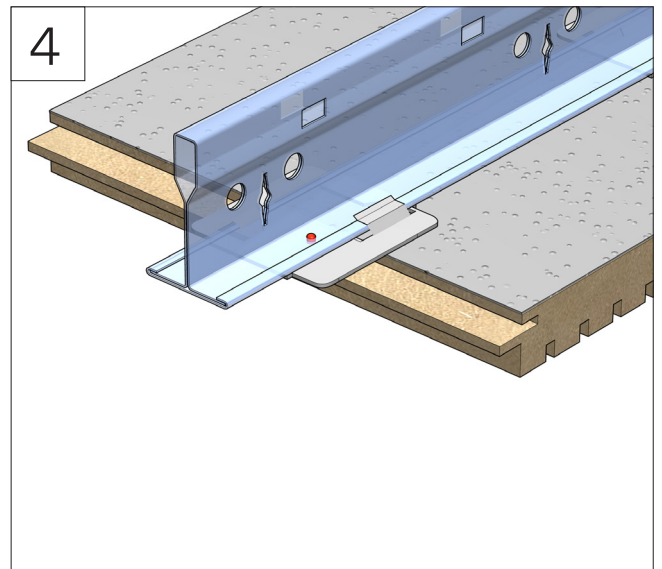
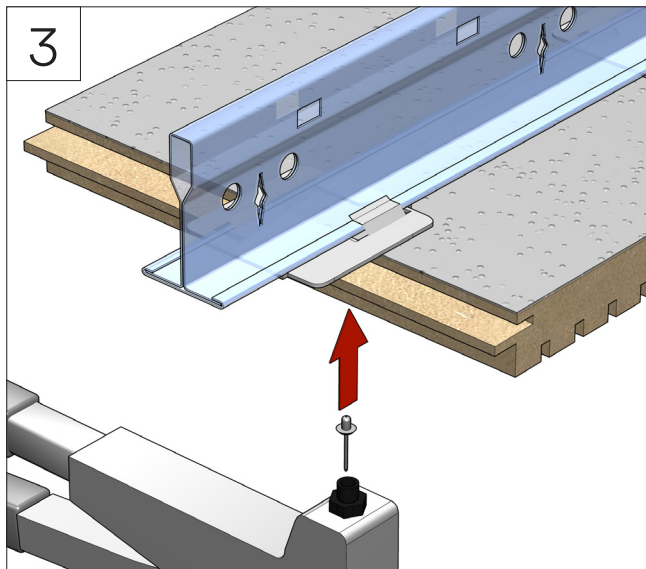
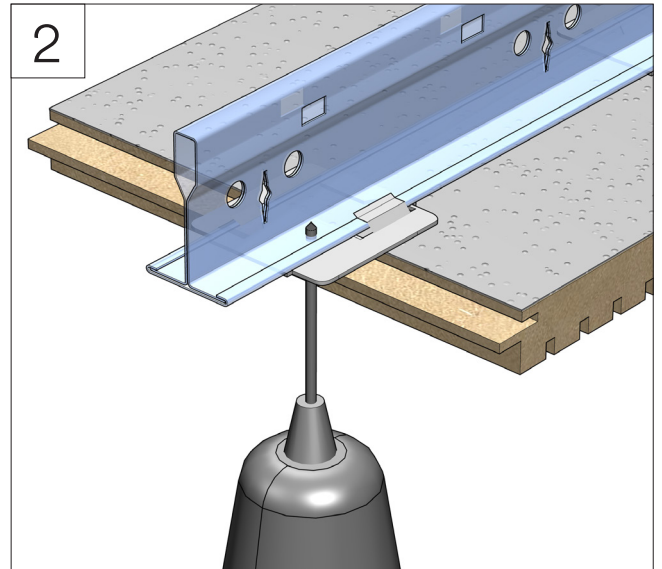
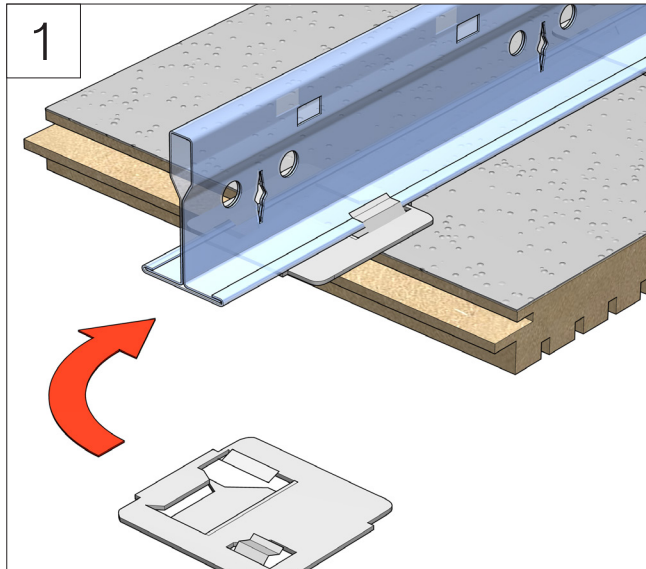

Suspension no. 1 and profile no. 2 are no Topakustik products (not in stock).

Installation with Topakustik Clip Type H 1 + 2 for MDF plank

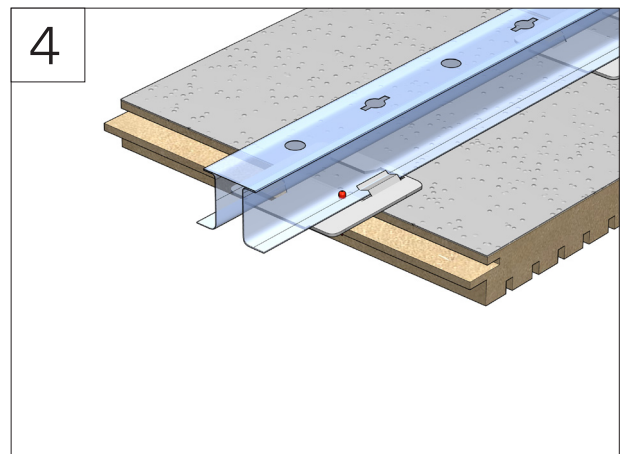
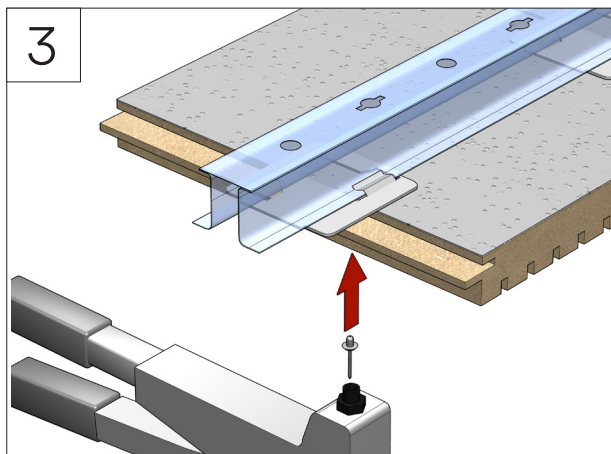
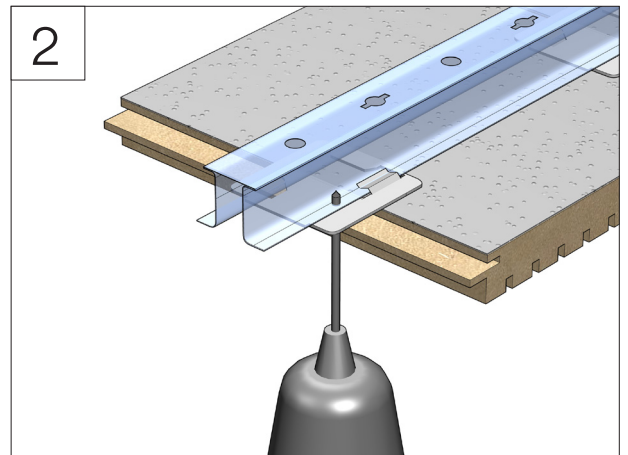
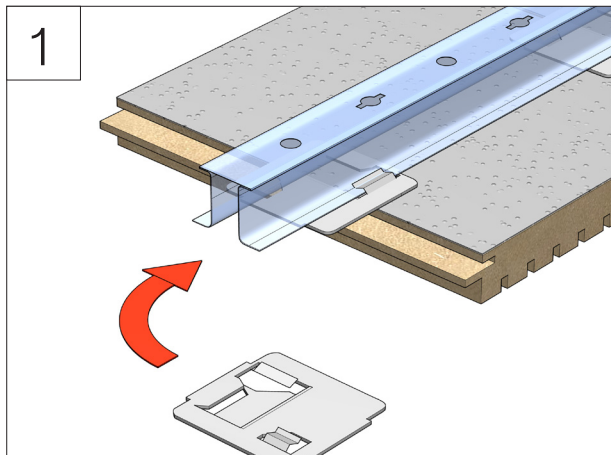

Installation with Topakustik Clip Type H1 + H2 for inflammable RESAP® core-plank and heavy base plates

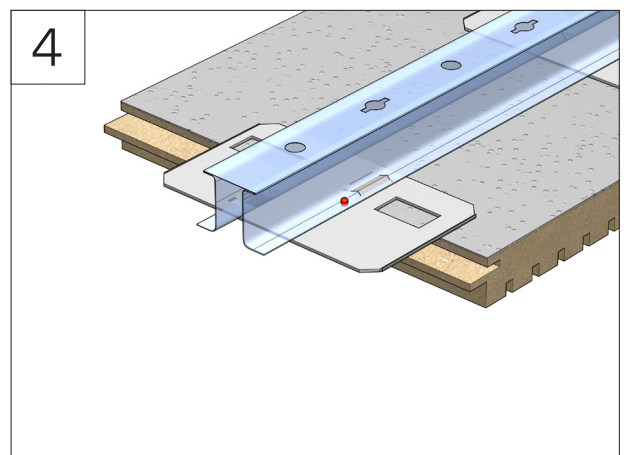
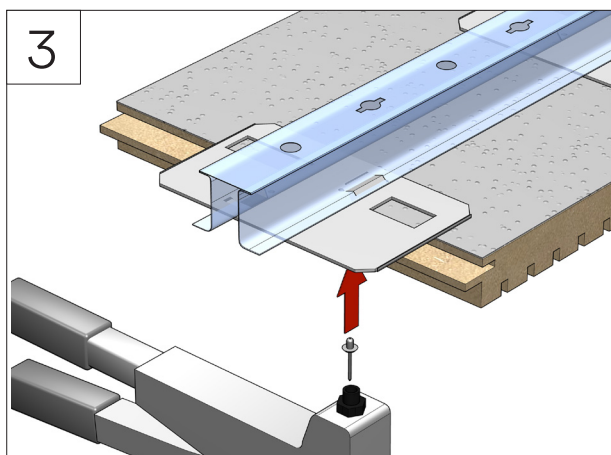
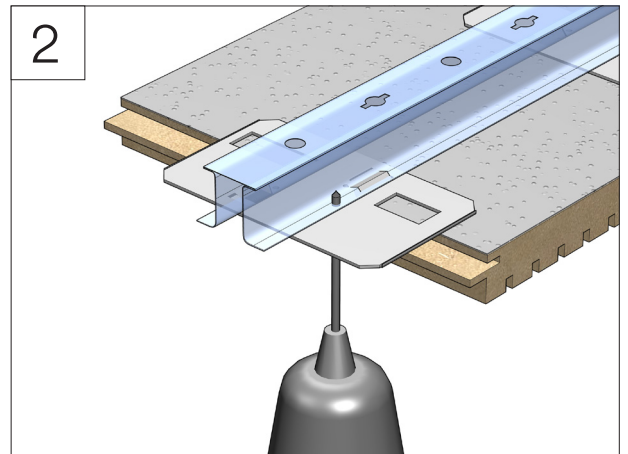
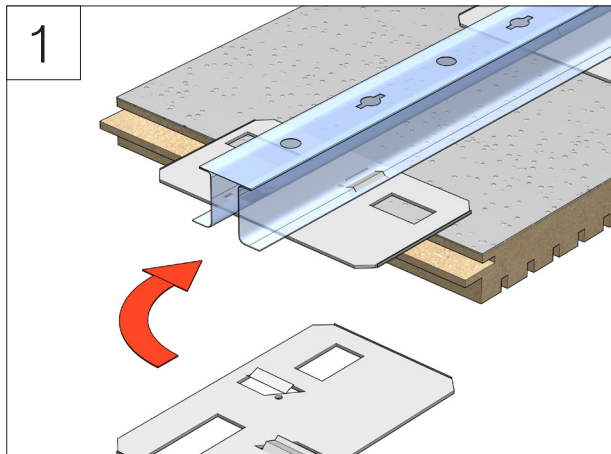

Access panel for W System

- Open and shut the access panel with rotary latch according to Pic. 1, 2 + 3
- Open and shut with allen wrench between the grooves, key \varnothing 3 mm
- For 2 mm width grooves a hole of \varnothing 3 mm has to be drilled.

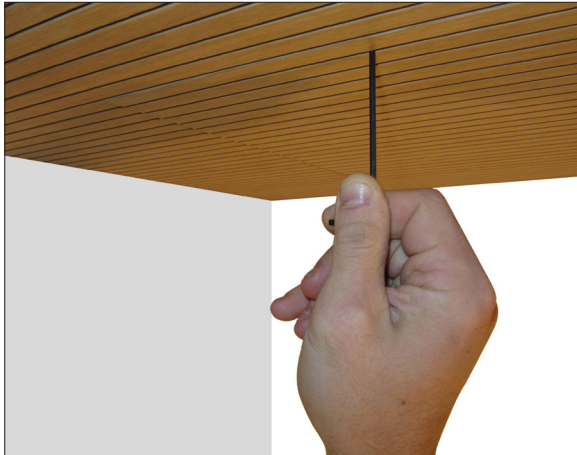

Pic. 1



Pic. 2

Open access panel downward (With latch set)

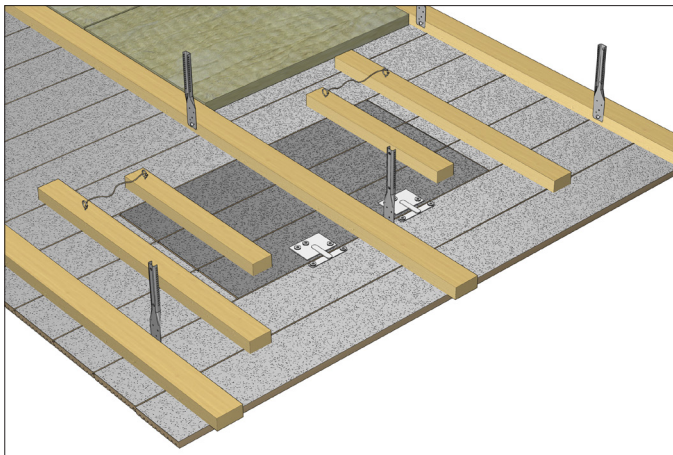

Latch Set

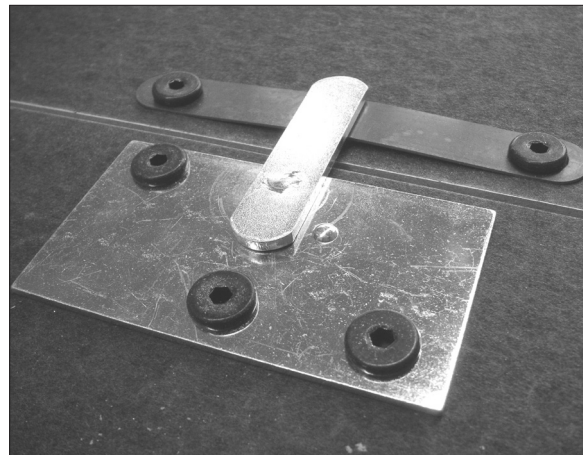

Pic. 3

Latch set	24.6001
Rotary latch	1 pcs.
Lock plate	1 pcs.
Screws	5 pcs.
Cords with ring screws	1 pcs.

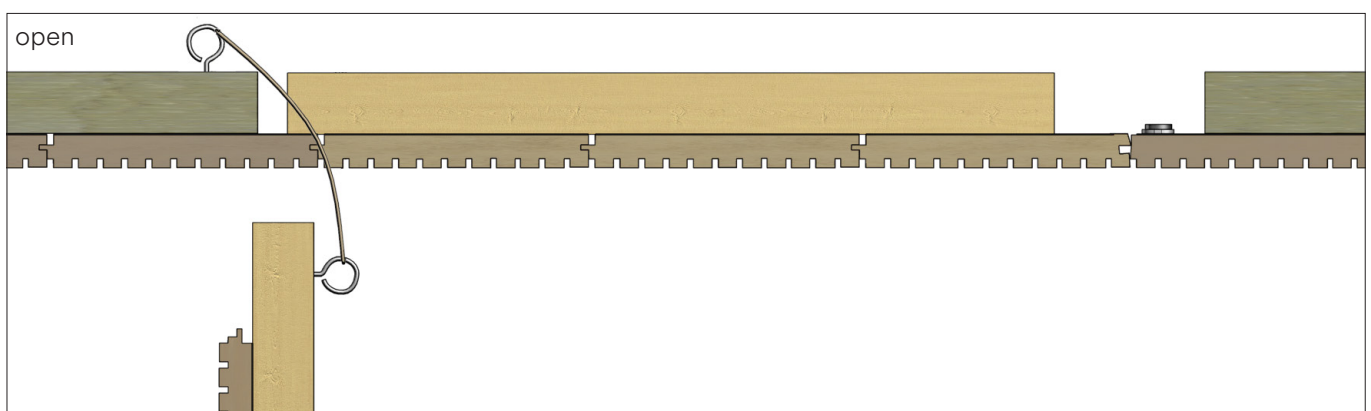
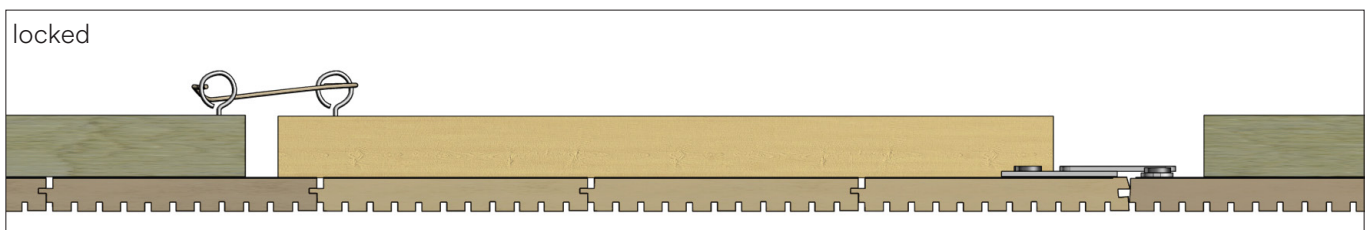

Access panel for W System opening upwards

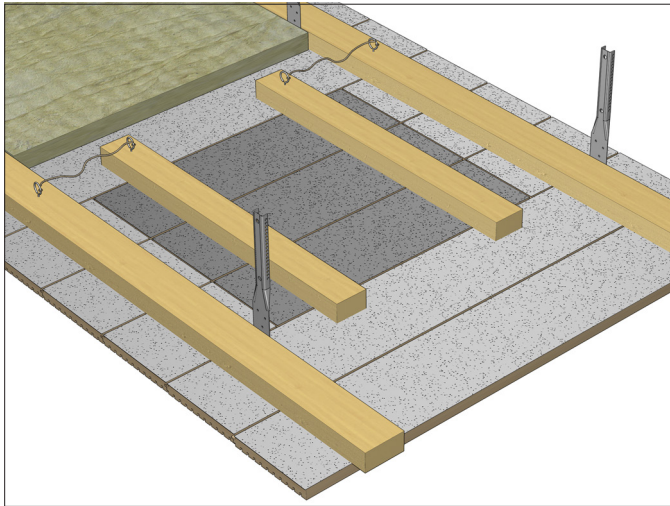

Access panel for H System made of L-profiles
Opening upwards

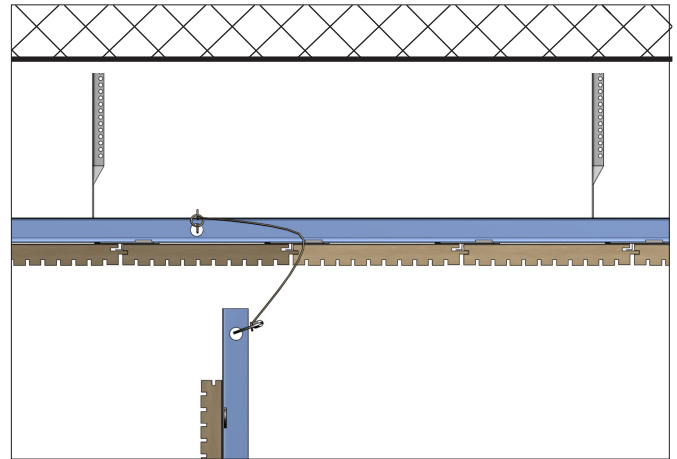
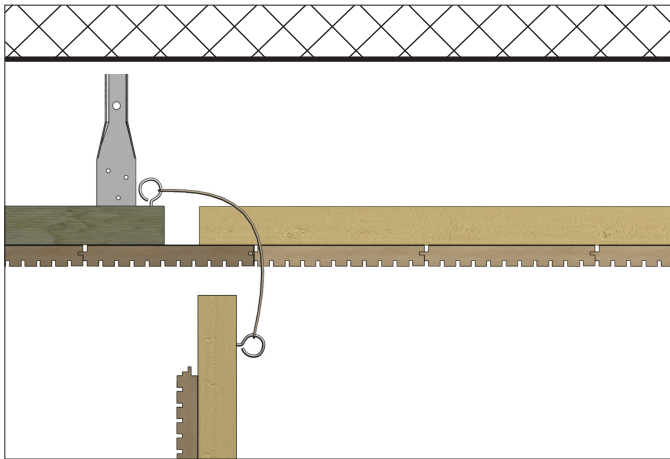
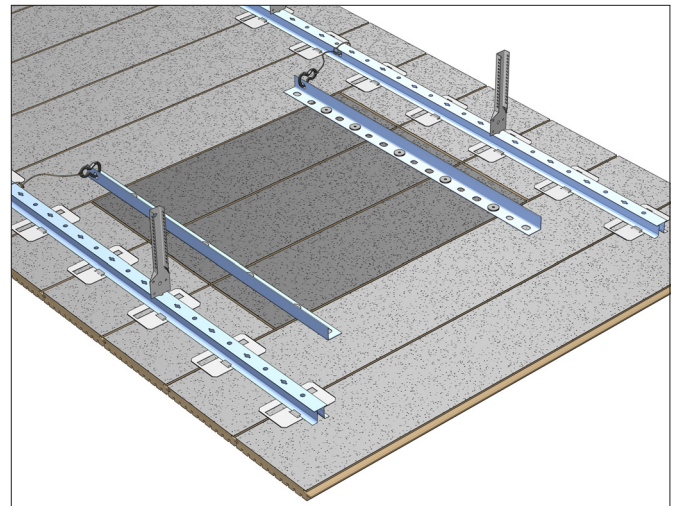

Design to lift and insert

- Access panel produced out of 3 planks, max. 450 mm in length
- Nail down 2 slats from front through the grooves to the rear side
- Cut access panel to exact length
- Cut off tongue alongside edge
- Install cord with ring screws

Design with H-profiles to lift and insert

- Access panel produced out of 3 planks, max. 450 mm in length
- Fix 2 steel angles to the rear side with special screws
- Cut access panel to exact length
- Cut off tongue alongside edge
- Fix cord to H-profile and steel angles (snap hooks)

H5 System - Walls – Planks installed horizontally

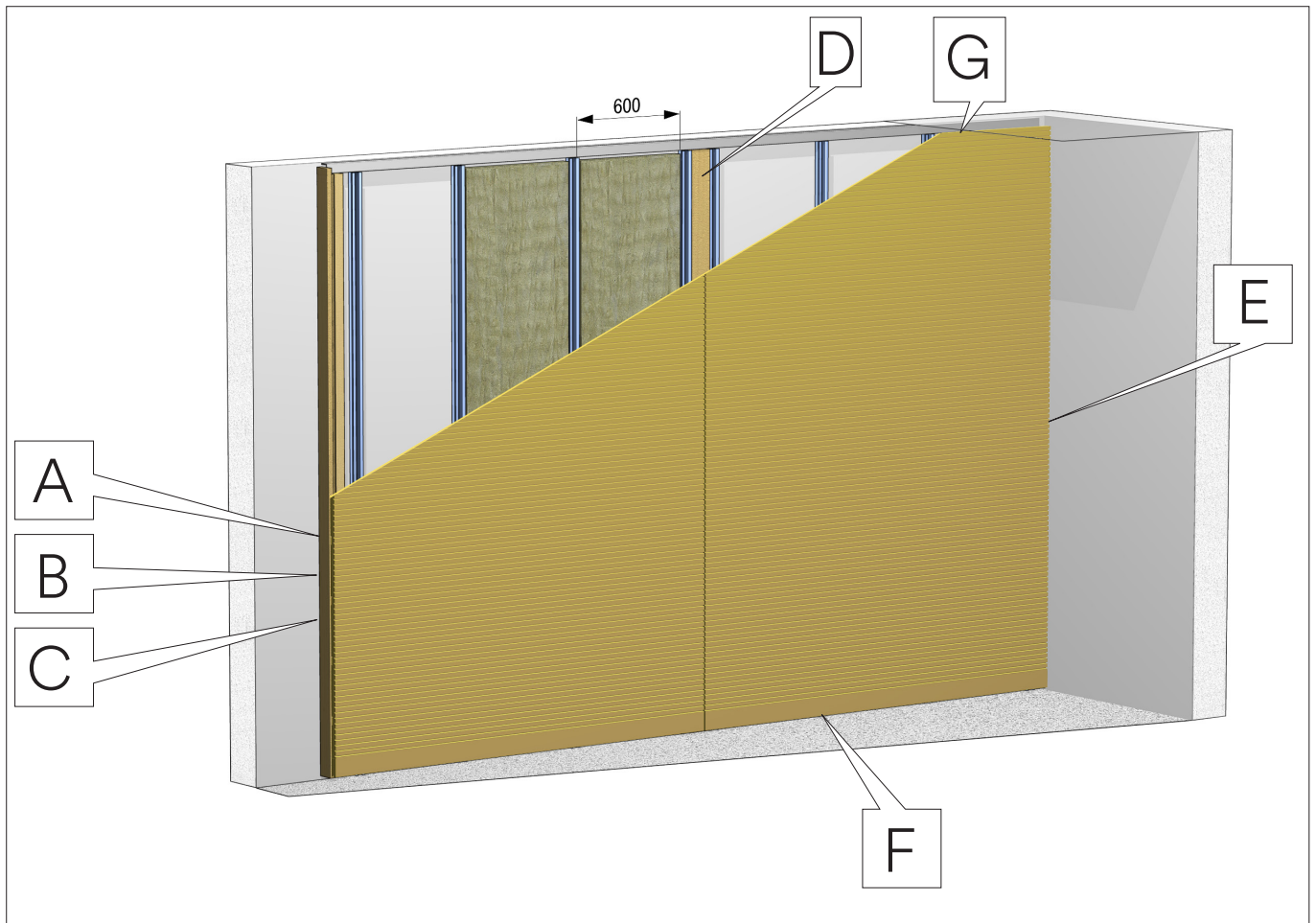

Edge ending and wall connection

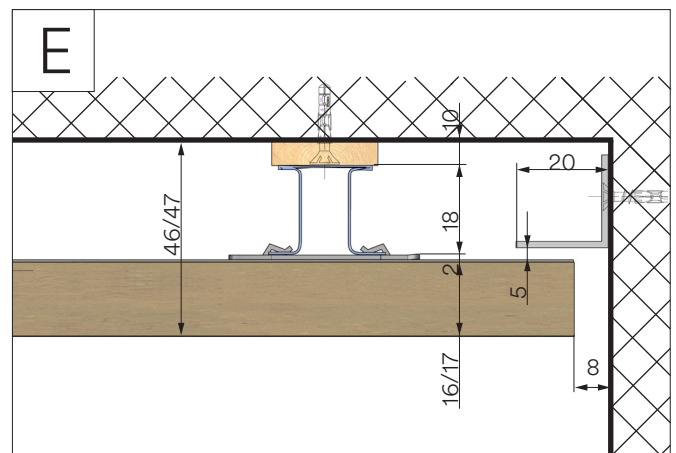
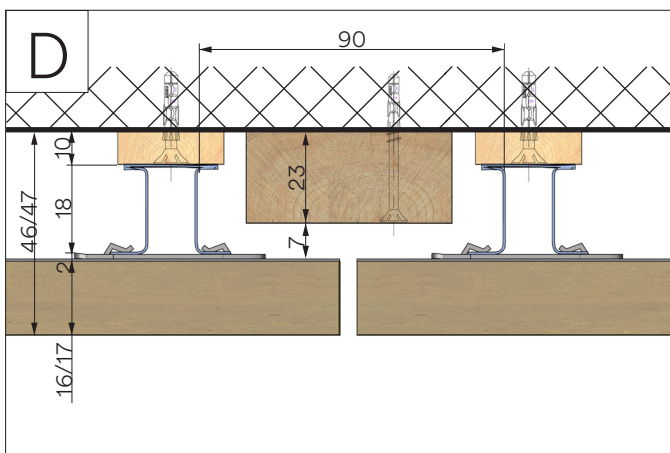
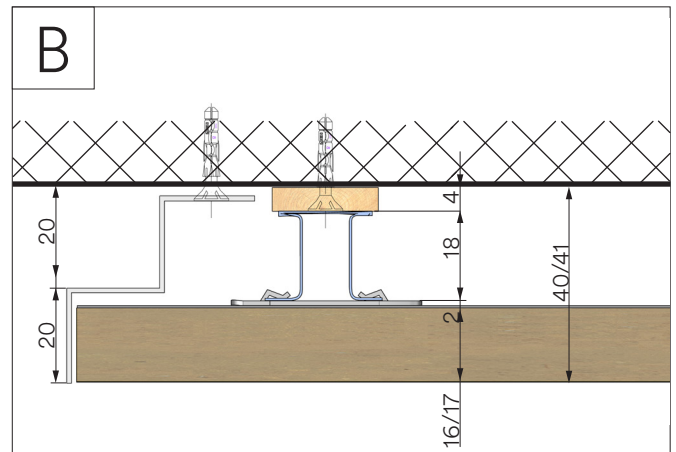
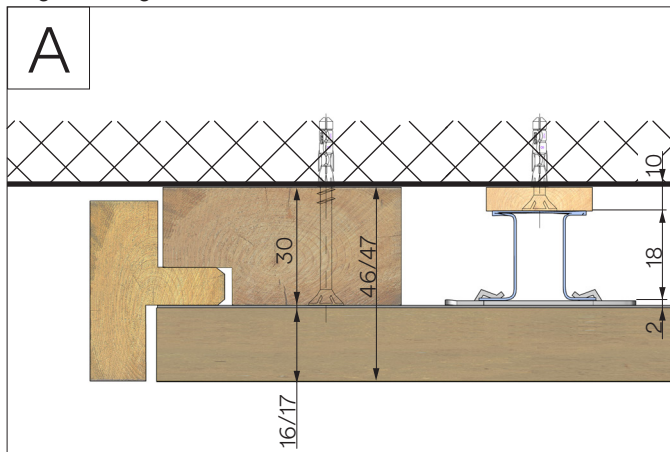

H5 System with edge ending and connection detail

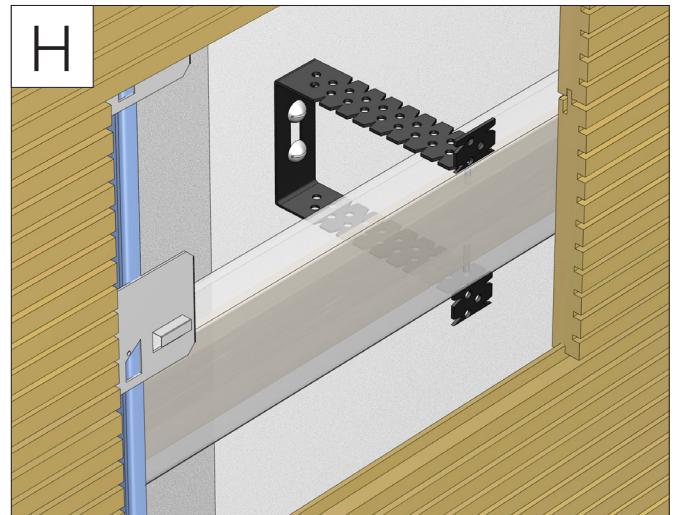
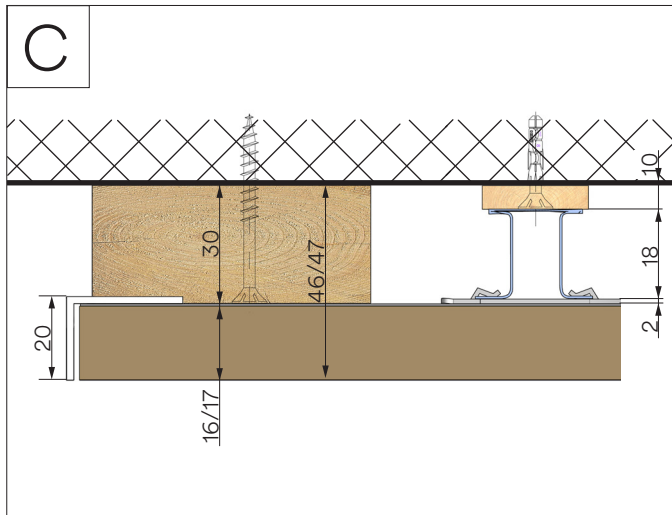

Substructure with spacer

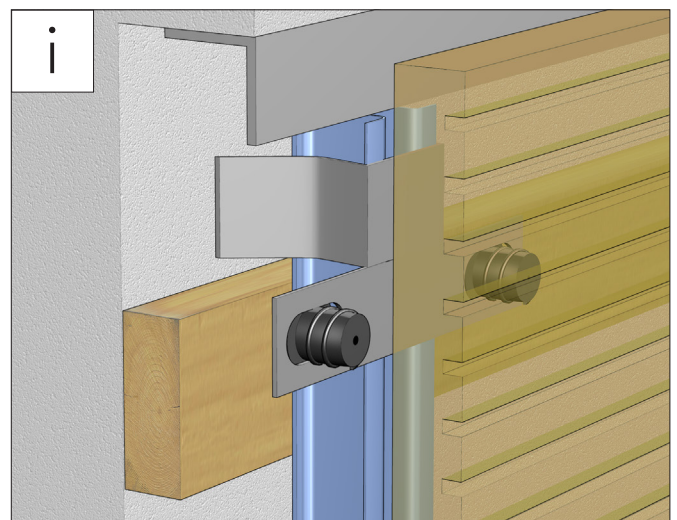
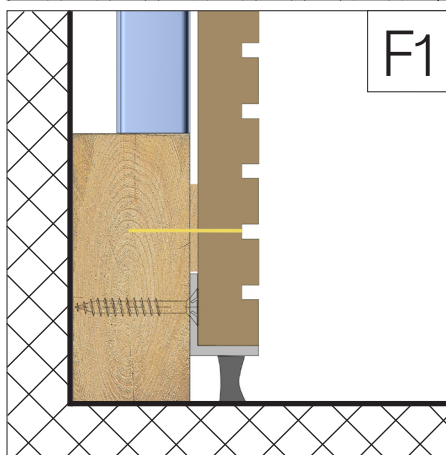
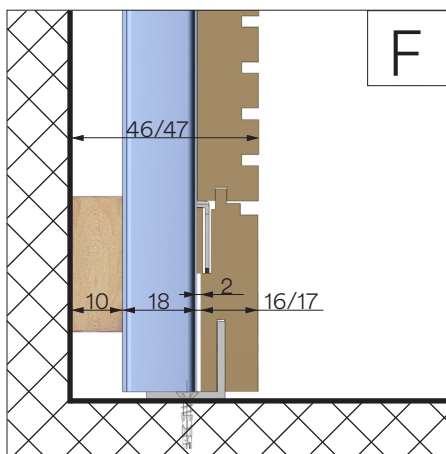
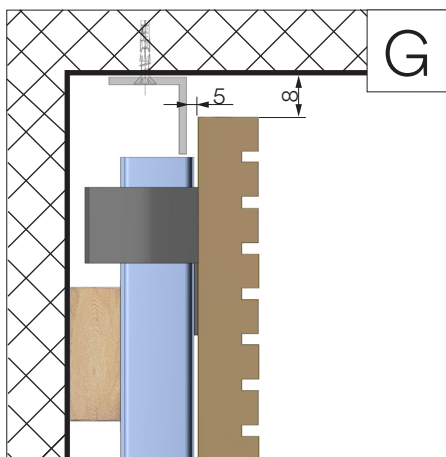

Fixation of end plank with clip

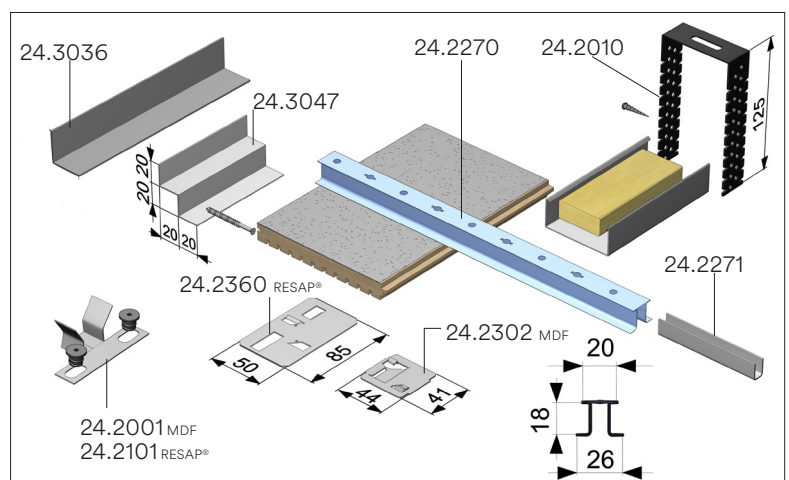

H6 System - Walls – Planks installed vertically

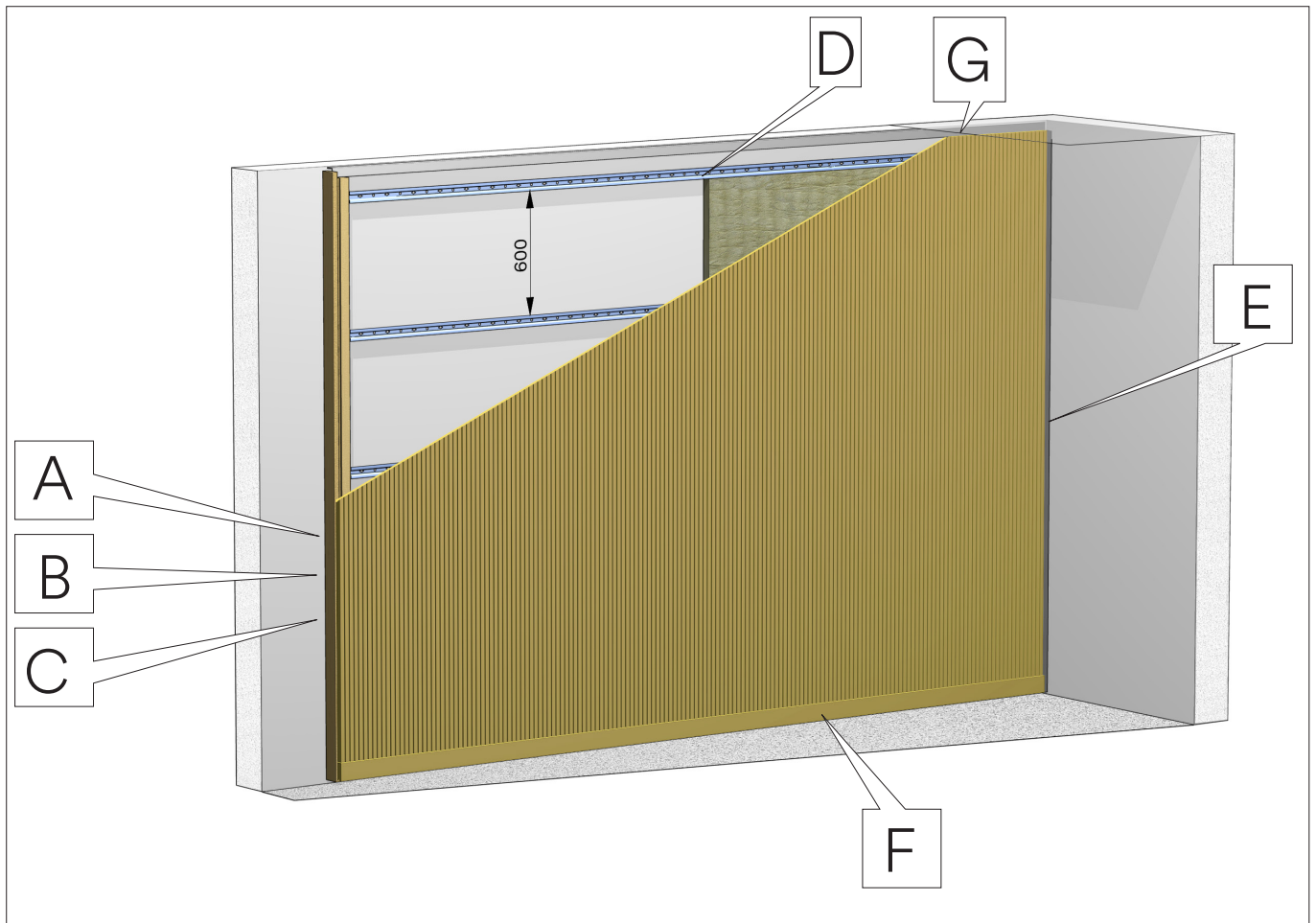

Edge ending and wall connection

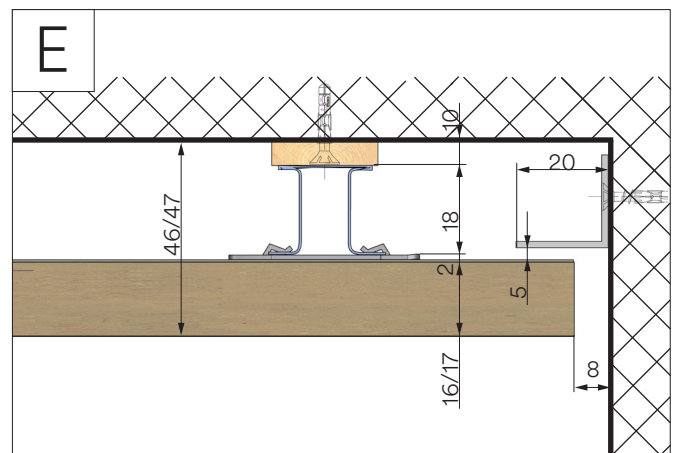
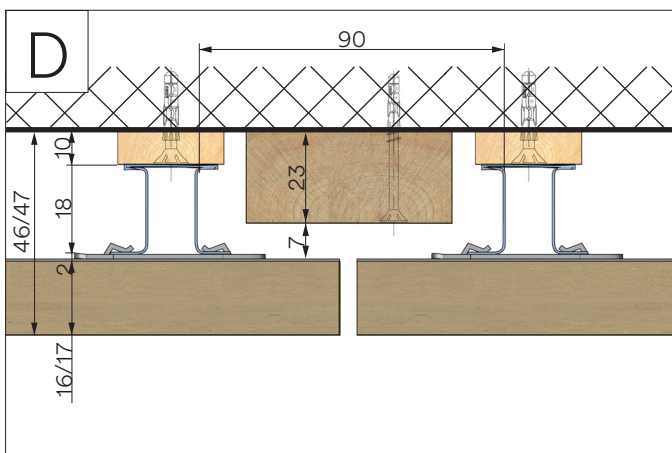
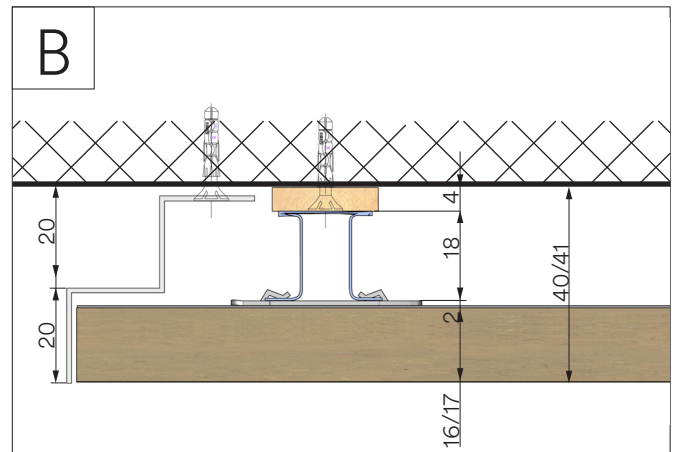
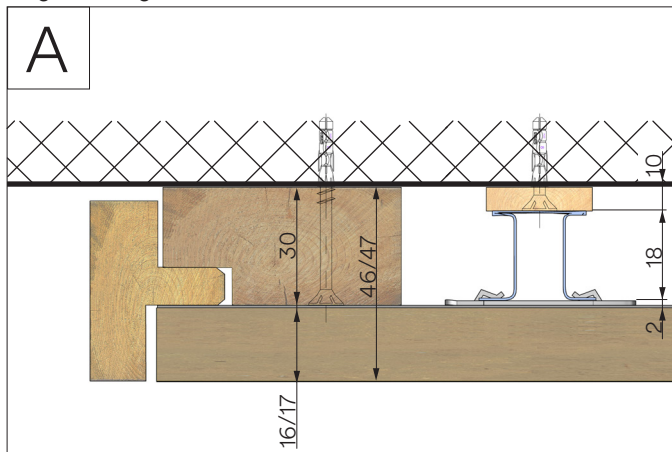

H6 System with floor and ceiling connections

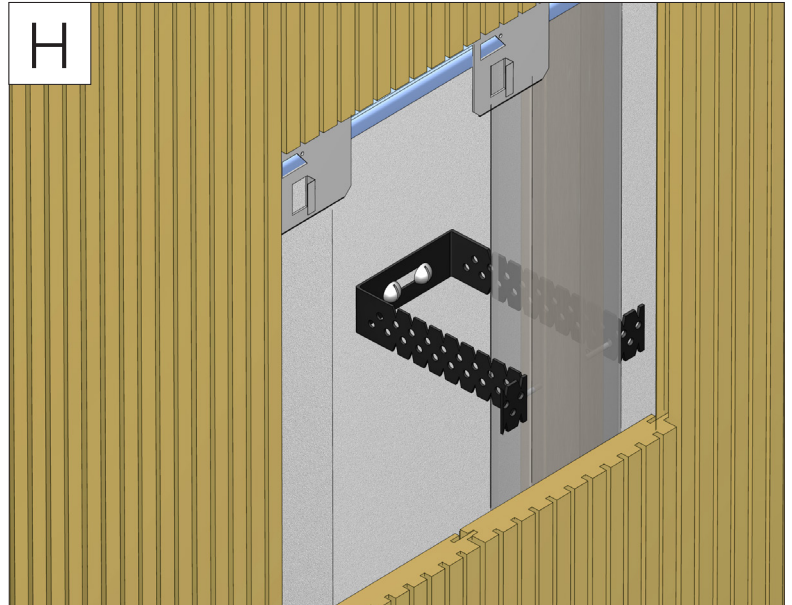
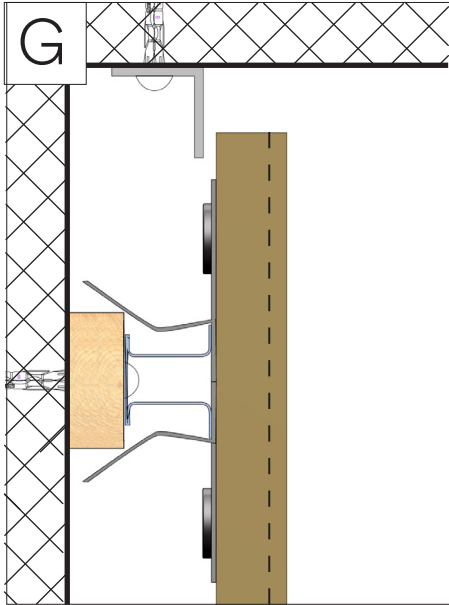

Substructure with spacer

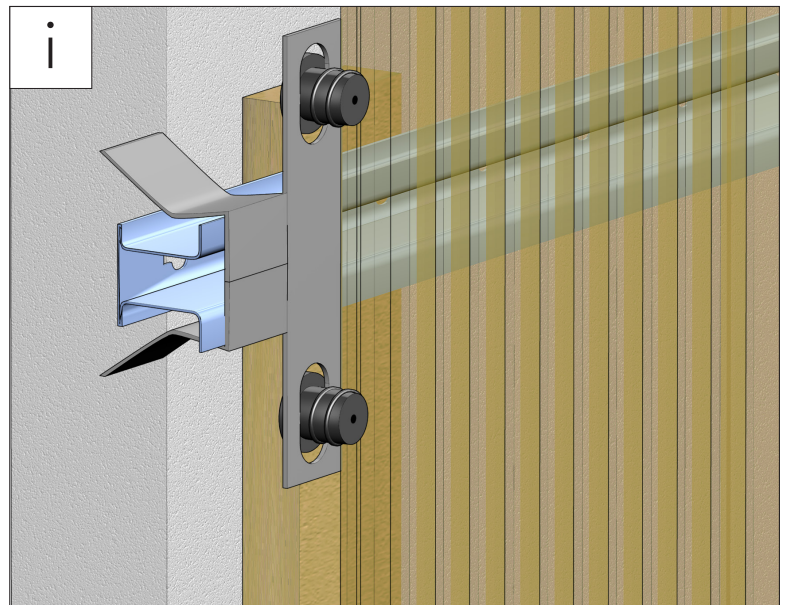
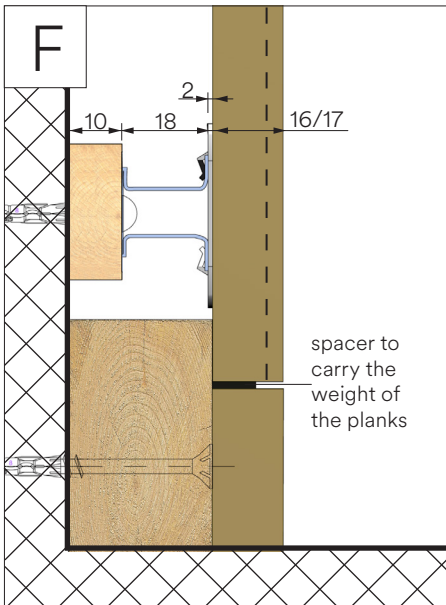

Fixation of end plank with clip

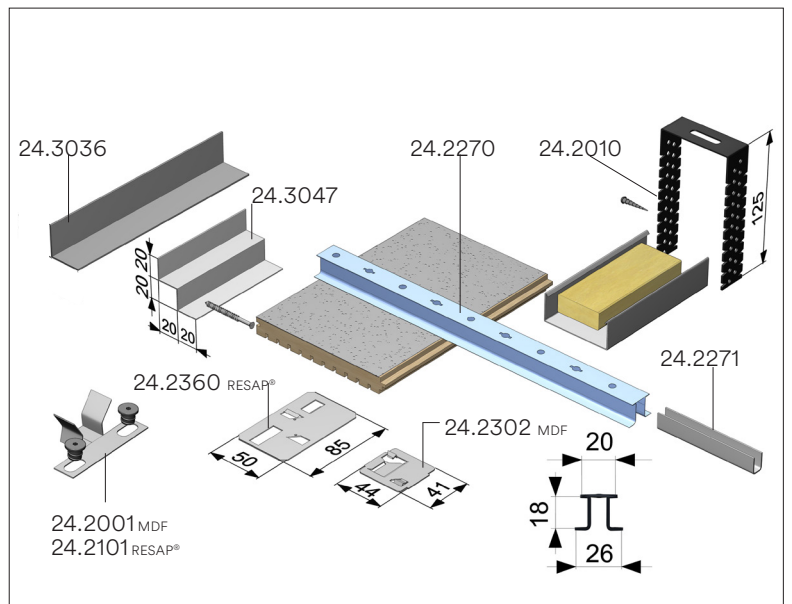
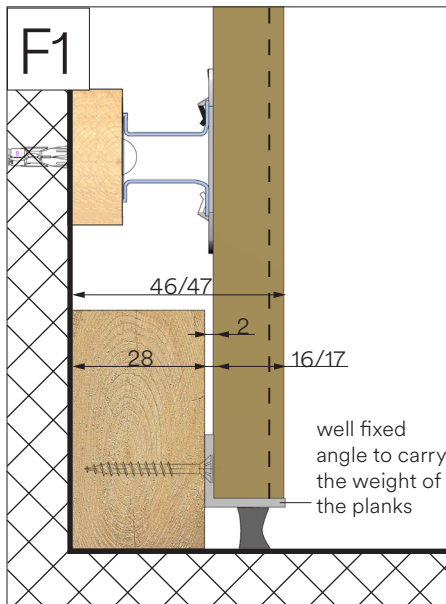

Sorting panels, joints, installation with a nail gun

Veneers

Topakustik-products are finished with selected veneers. Each veneer trunk has different natural characteristics (growth, colour, etc.). We recommend sorting the Topakustik-elements aesthetically prior to installation.

Placement type

Place the cross pieces such that a slat is used under each joint for fixation.

Parallel

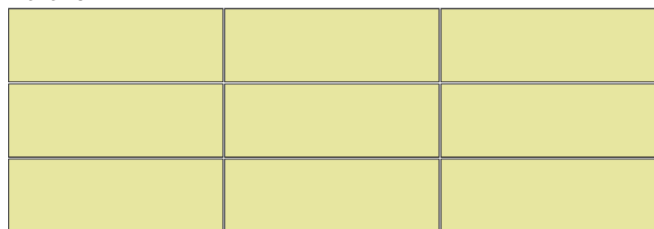

Pic. 1

English

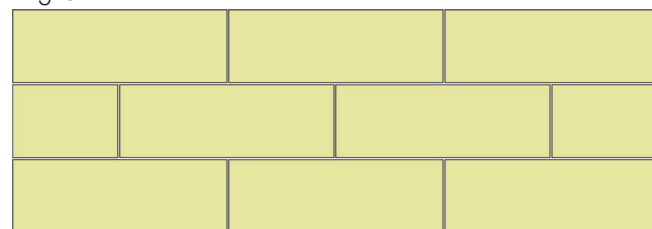

Pic. 2

Longitudinal and transverse joints

Topakustik panels are available with different edge types, such as raw cut edge, with tongue and groove connection as well as coated/lacquered like the surface. For expansion reasons, the longitudinal and transverse joints are to be installed at least 3-4 mm wide in order to absorb changes in size due to fluctuating room humidity. Joints must be furnished with a slat (pic. 3).



Pic. 3

Parallel transverse joints (pic. 1 and 3)

Topakustik panels must be subsequently cut in length in the installed and climatized state (see page 4 + 5) using a Lamello cutter or shadow joint cutter. In the event of changes in room humidity at the place of storage or installation, dimension differences may arise prior to installation.

Topakustik panels

Topakustik panels can be fixed with the Topakustik nail gun incl. "special foot" through the grooves, as shown in pic 4 -6. Distance between the clips for normal ceilings approx. 250 mm, for sports halls max. 100 mm.



Pic. 4



Pic. 5

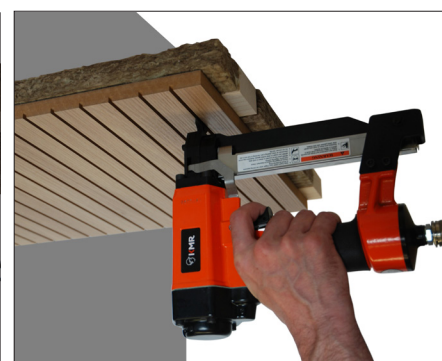

Pic. 6

Topakustik-nail gun



Pic. 7

For the installation (Pis. 4-6) the "special foot" must be inserted.



Pic. 8

X1 System - Ceiling – Installation with staple gun on slatted grid

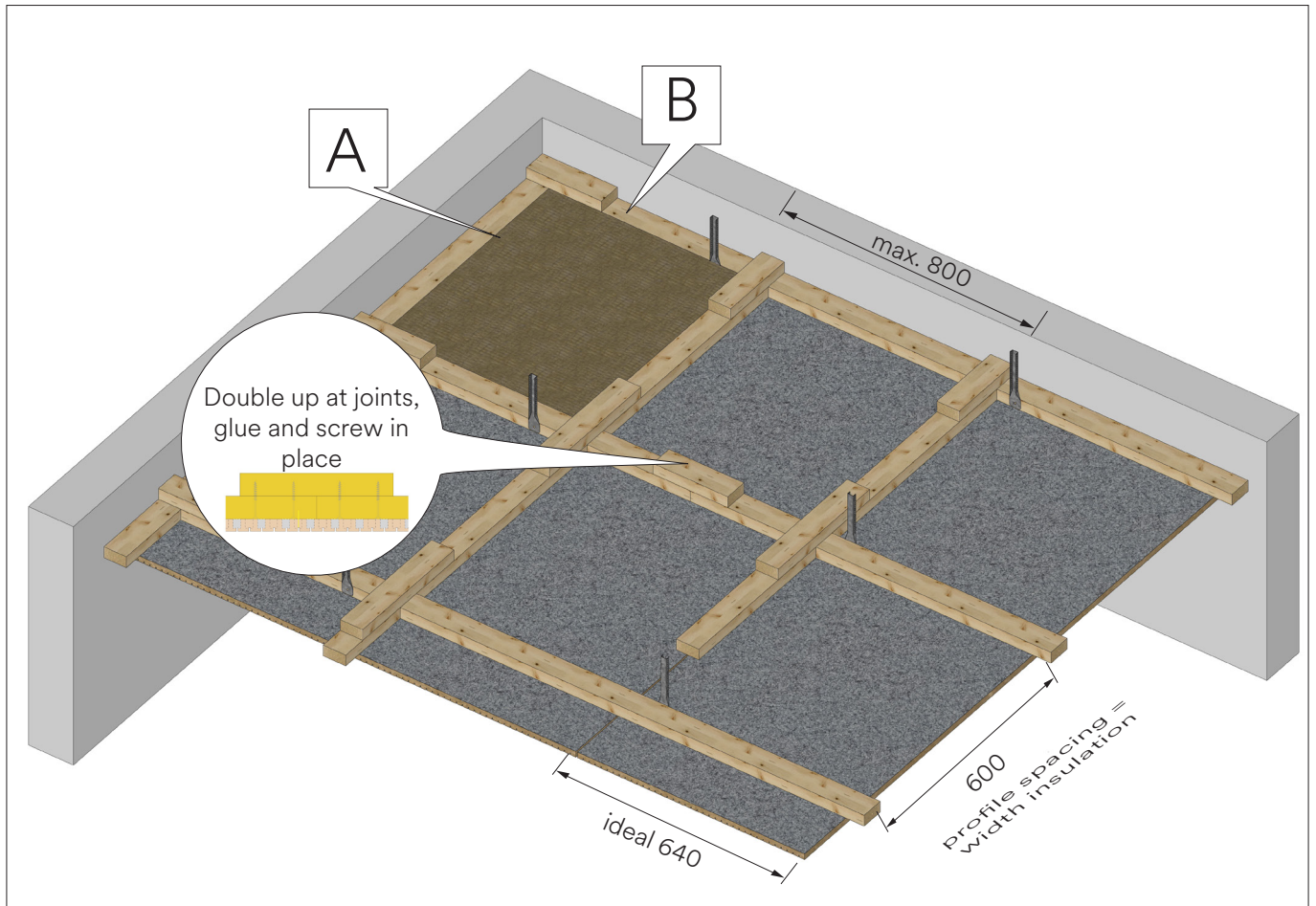

Wall connection

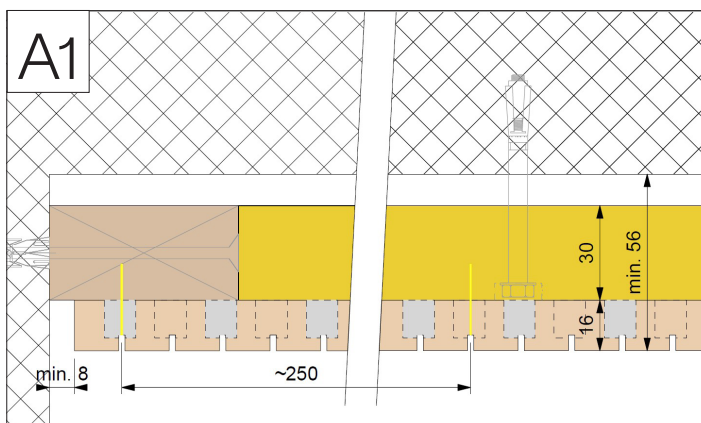
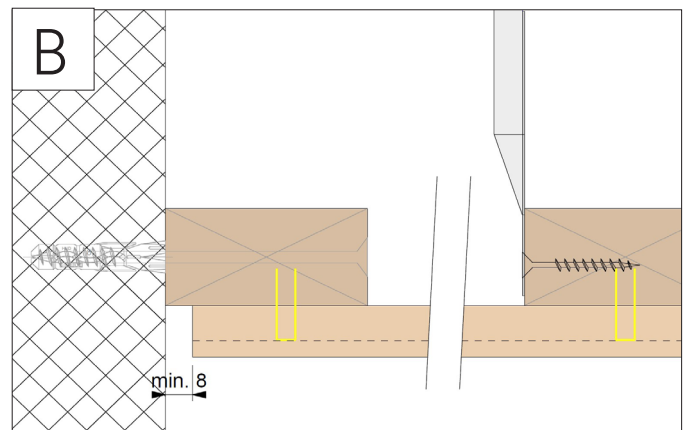
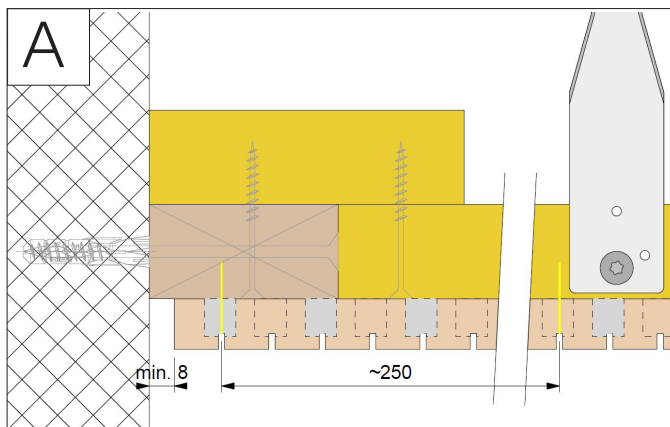

Installation on vertical slats made from wood (wood moisture max. 10%)

Topakustik panels (without increased fire protection requirement) are fitted on perfectly installed cross pieces made from planed, dry spruce wood slats 60/30 mm.

When installing the slats using nonius hangers (arrange hangers offset to the left and right of the slats), distance between hangers 800 mm, arrange Topakustik element joints on the cross batten. Please observe shrinkage and swelling behaviour (see "Important notes" page 4 + 5).

X2 System - Ceiling – Installation with staple gun on counter grid

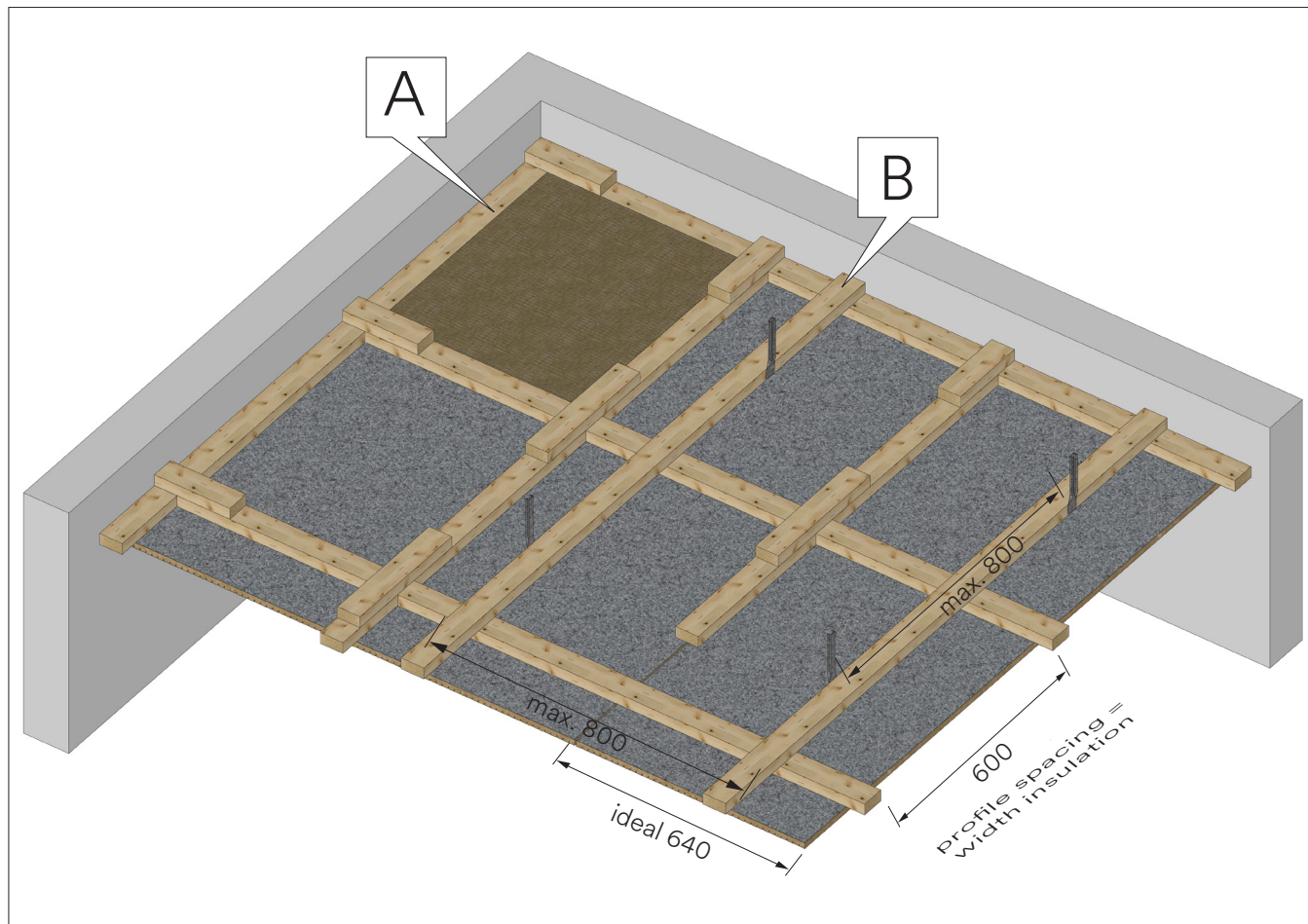

Wall connection

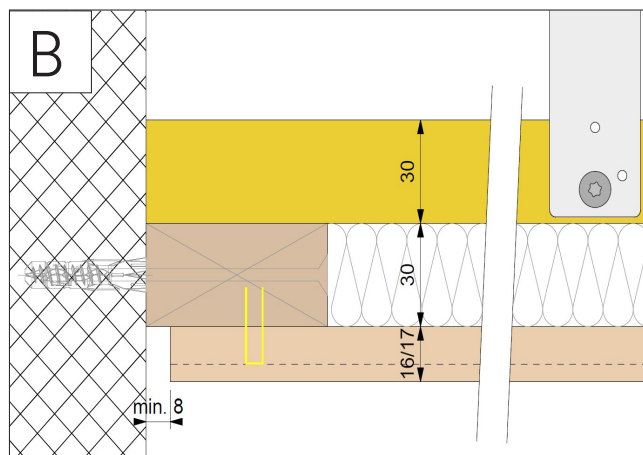
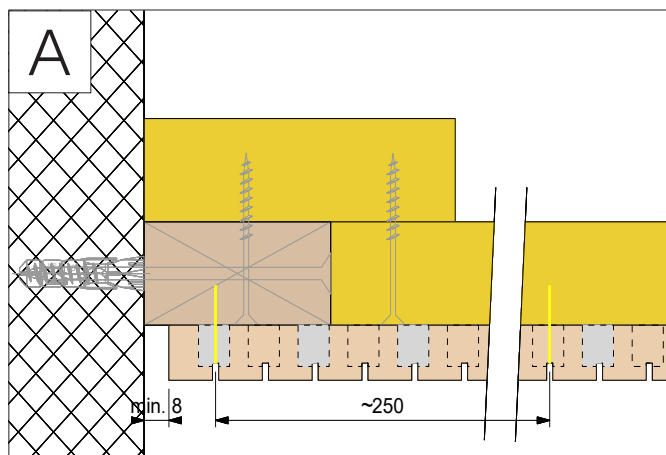

Panel joint variants below, applicable to ceiling systems type X1 + X2

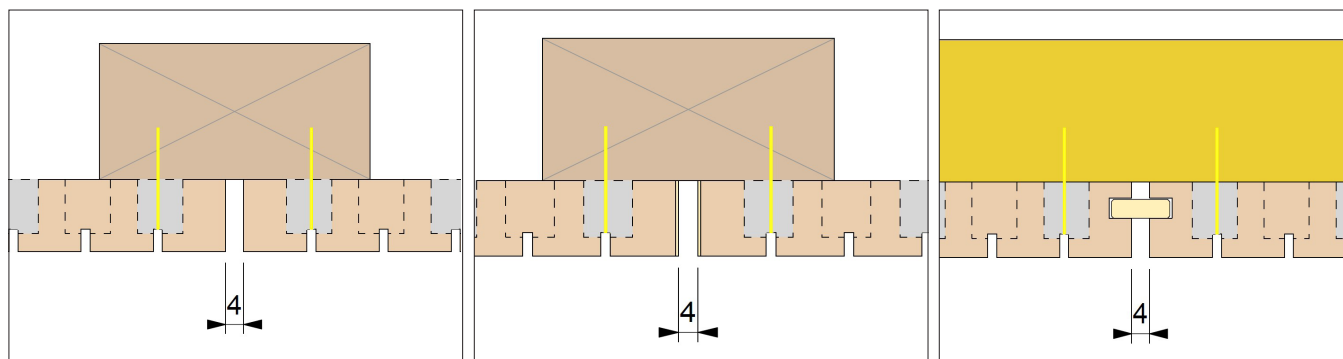

X3 System - Walls – Installation with staple gun horizontally

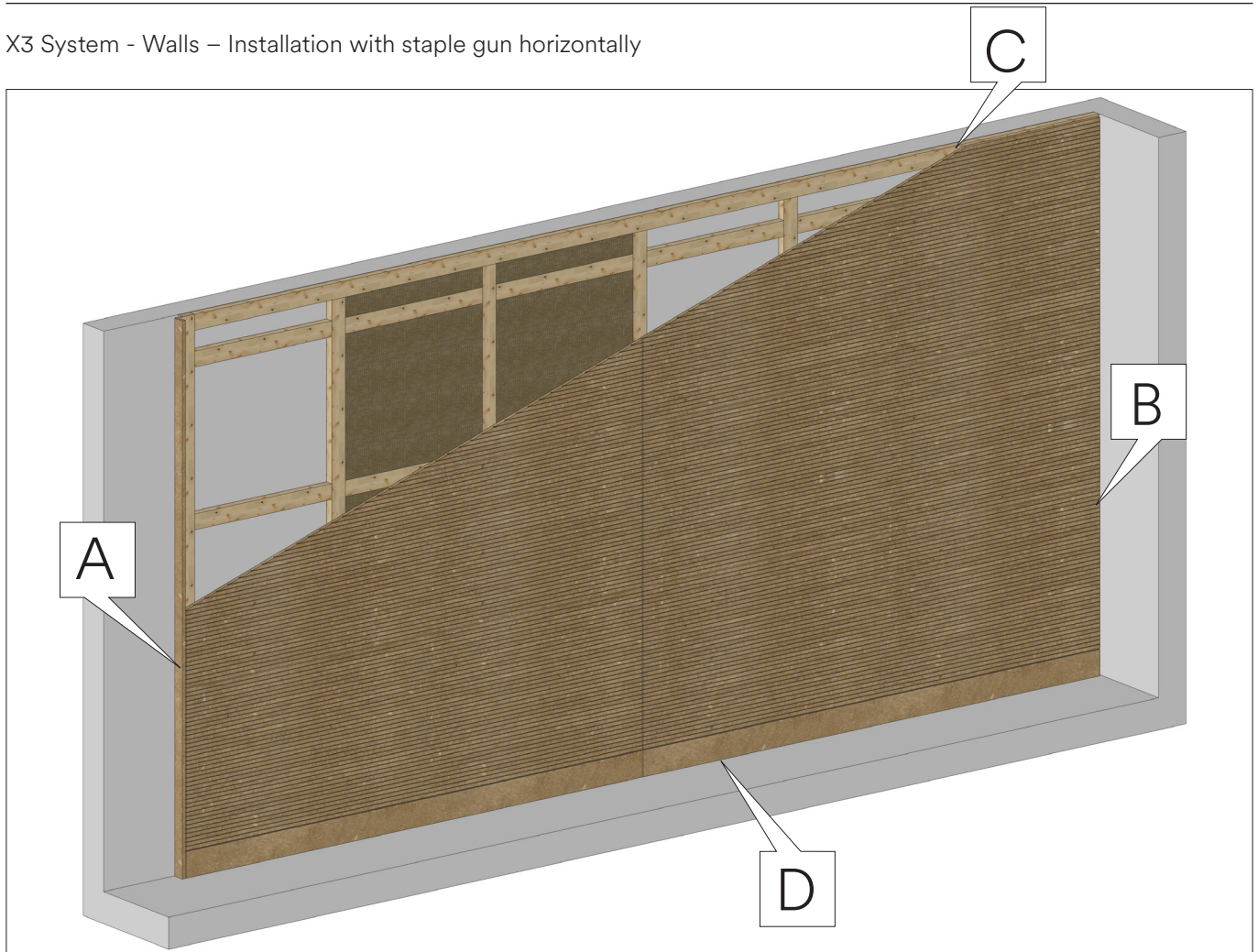

Edge ending and Wall connection

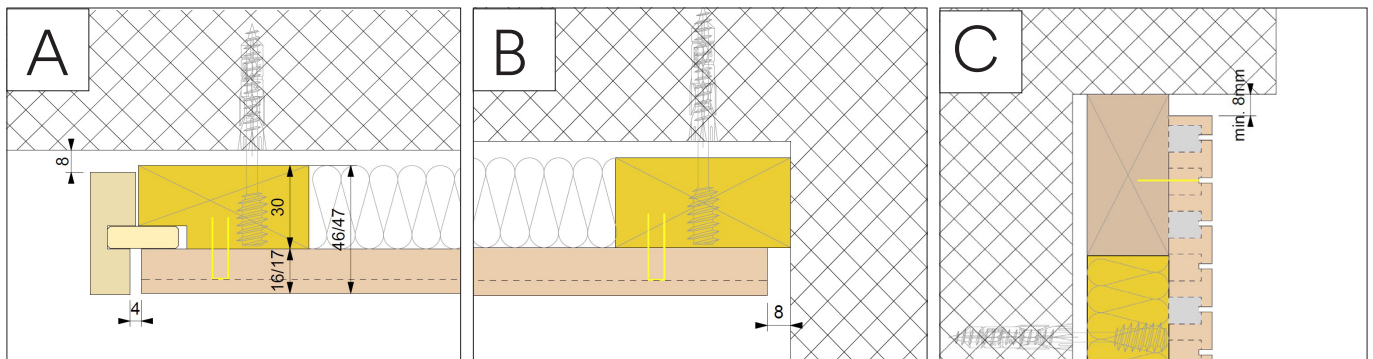

Installation on wood slats (wood moisture max. 10%)

Substructure:

Topakustik panels (without increased fire protection requirement) are fitted on perfectly installed cross pieces made from planed, dry spruce wood slats 60/30 mm.

Use spacers or spacer bolts to fix to bare wall when installing slats (observe manufacturer's information from the supplier of the fixing material). Panel joints must be furnished with a slat.

Please note shrinkage and swelling behaviour (see "Important notes" page 4 + 5)

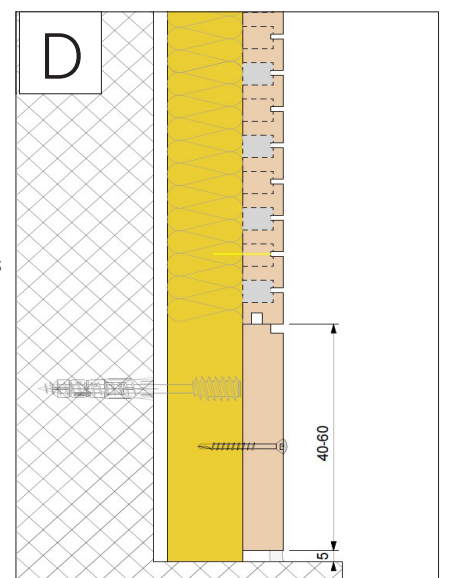

X4 System - Walls – Installation with staple gun vertically

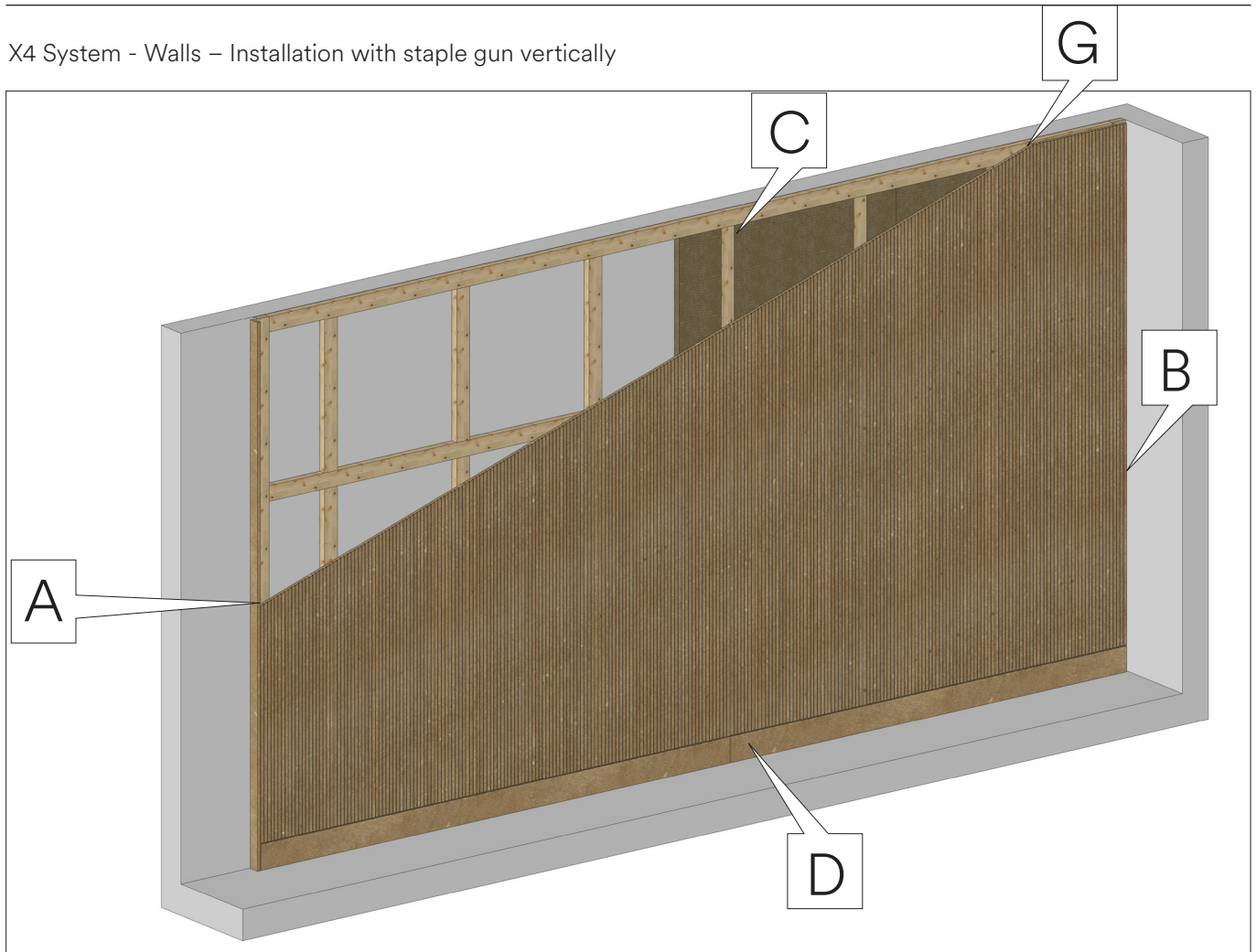

Edge ending and Wall connection

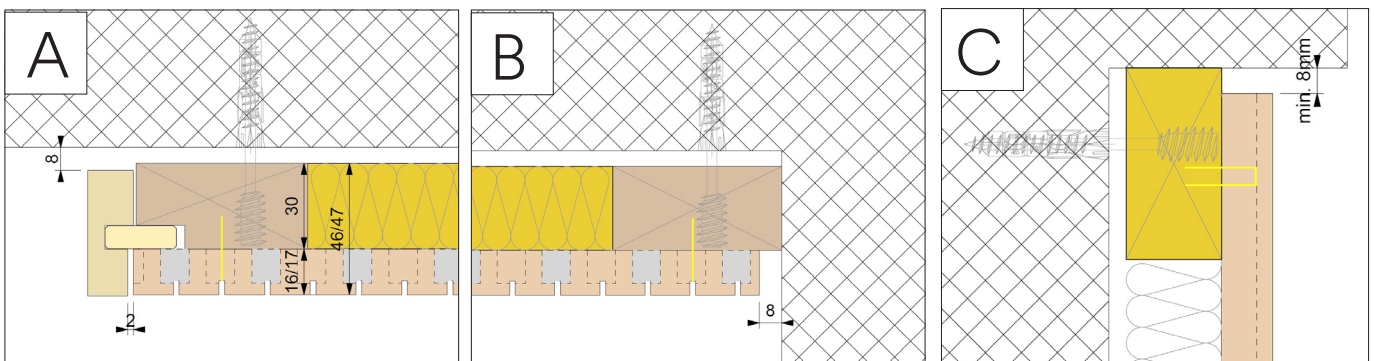

Installation on wood slats (wood moisture max. 10%)

Substructure:

Topakustik panels (without increased fire protection requirement) are fitted on perfectly installed cross pieces made from planed, dry spruce wood slats 60/30 mm.

Use spacers or spacer bolts to fix to bare wall when installing slats (observe manufacturer's information from the supplier of the fixing material). Panel joints must be furnished with a slat.

Please note shrinkage and swelling behaviour (see "Important notes" page 4 + 5)

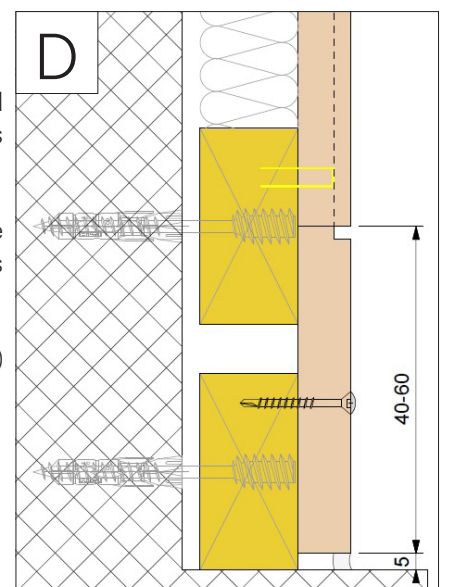

CHS System for universal application

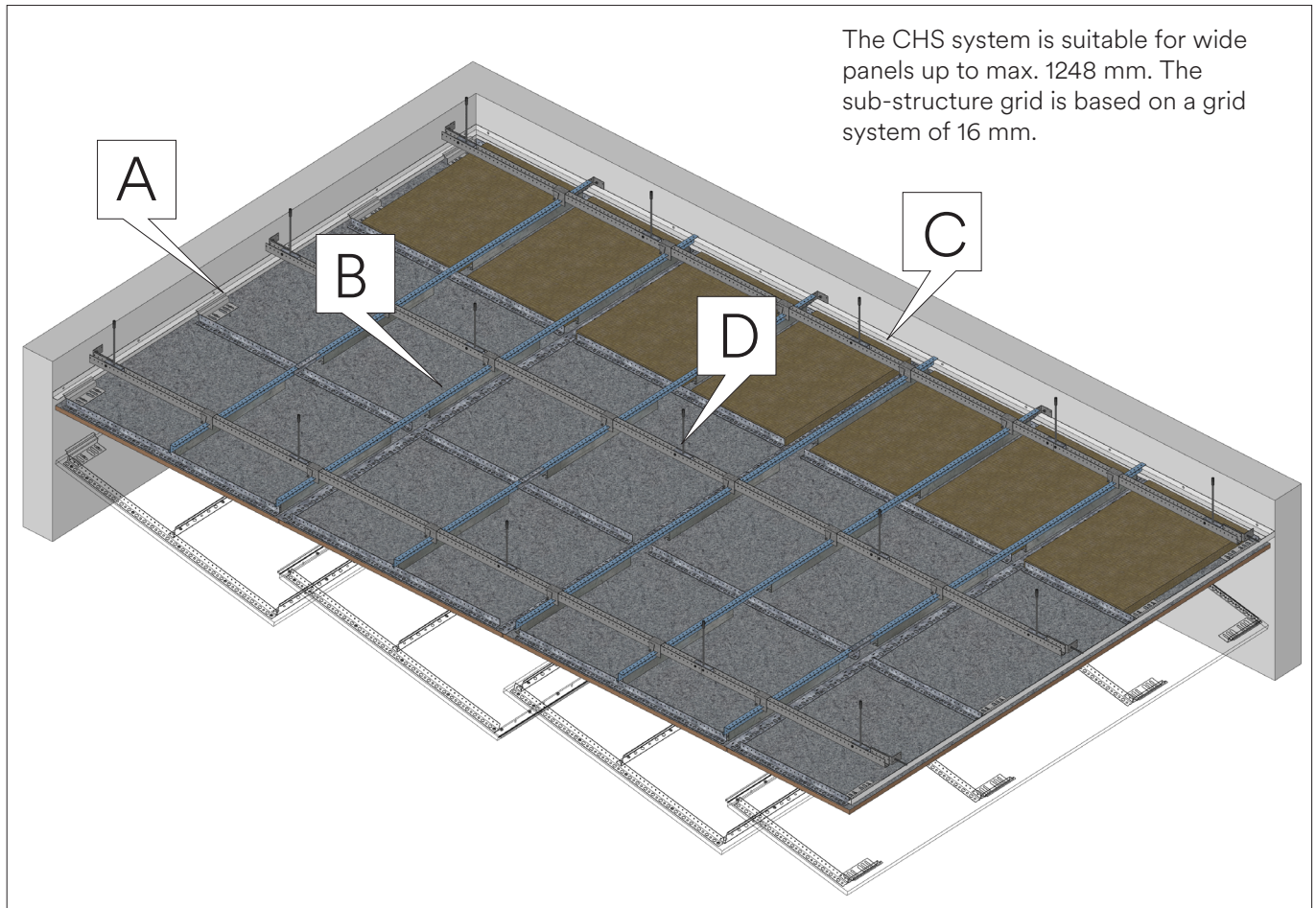

The CHS system is suitable for wide panels up to max. 1248 mm. The sub-structure grid is based on a grid system of 16 mm.

Wall connection

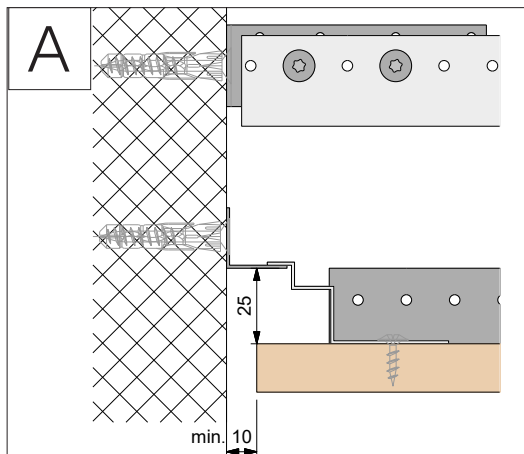

Butt joint typical detail

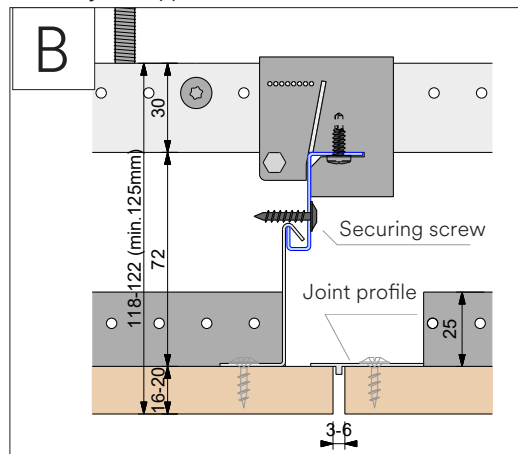

centre panels lays on secondary panels. Joint formations 3-6 mm possible.

Due to material expansion, the joints of grooves panels must always be 2 mm wider than the groove width.

Wall connection

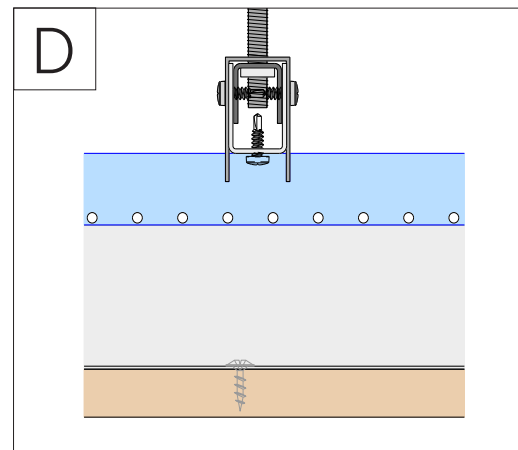
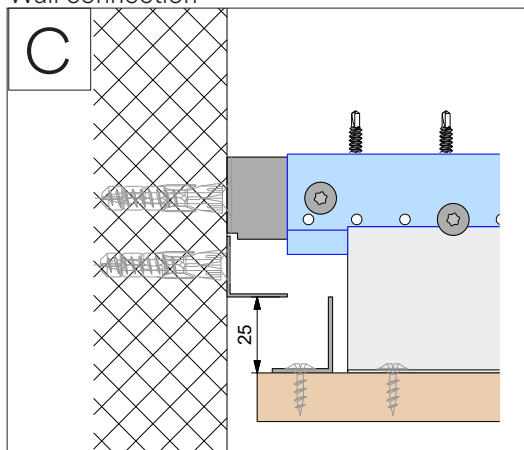

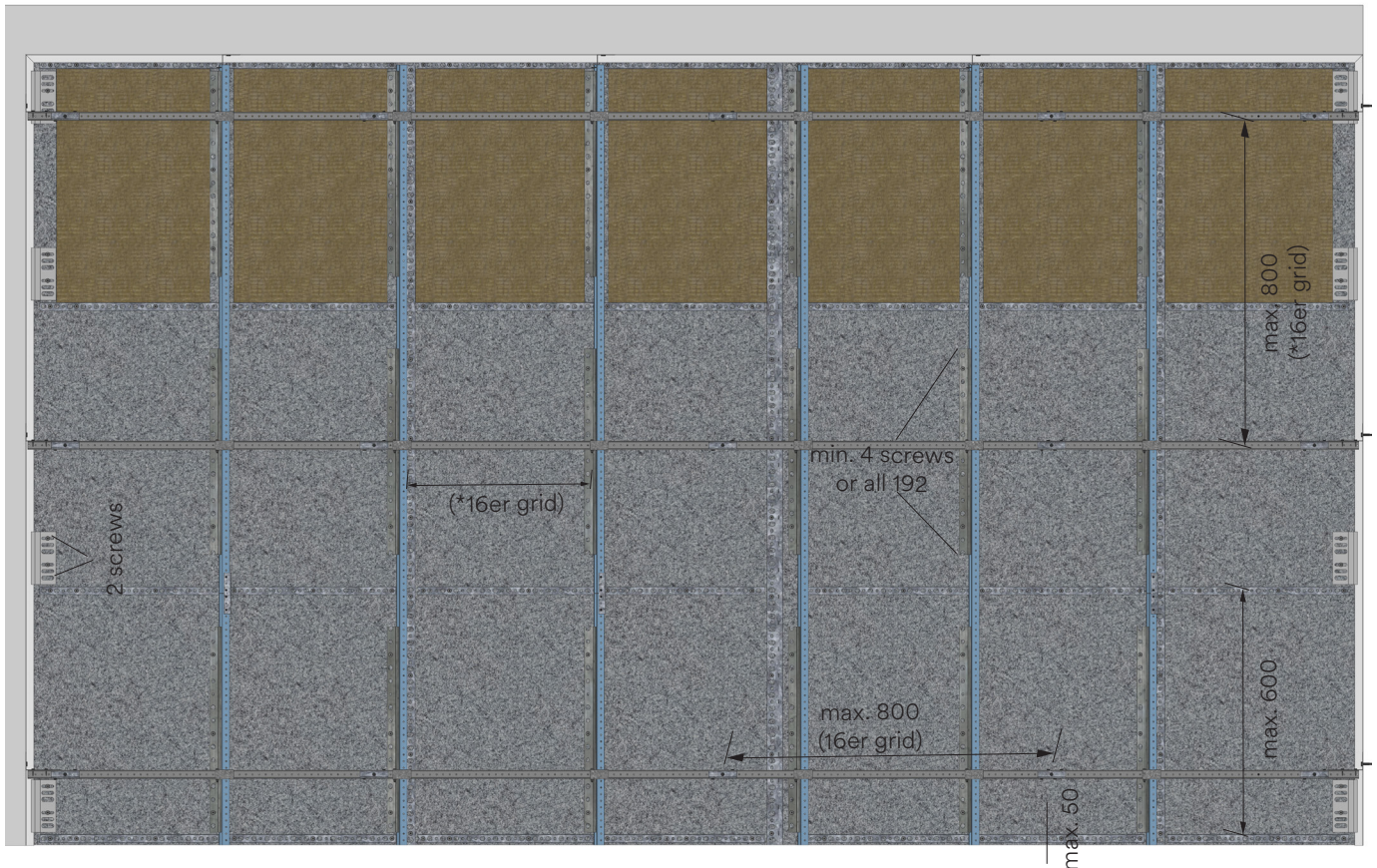

Installation information:

The distance between the suspension points (threaded rods) is a max. of 800 mm lengthwise and crosswise. When mounting the counter profiles (24.8004), ensure they are aligned with the support profiles' (24.4101) 16 mm grid. The support profiles should be attached to the counter profile using a tapping screw (24.8009) and additionally secured (Fig. 1) with the clamp hanger (24.3307). The bracings (24.8002) must absolutely be continuous over the entire length of the panel. The panel profiles (24.4100) are to be cut and mounted between the bracings (screw distance 192 mm, *Panel widths over 600 mm require an additional suspension profile in the centre of the panels). The longitudinal and safety clip (24.4104) is used for both the lengthwise positioning and for securing the panels from lifting (Pic. 2).

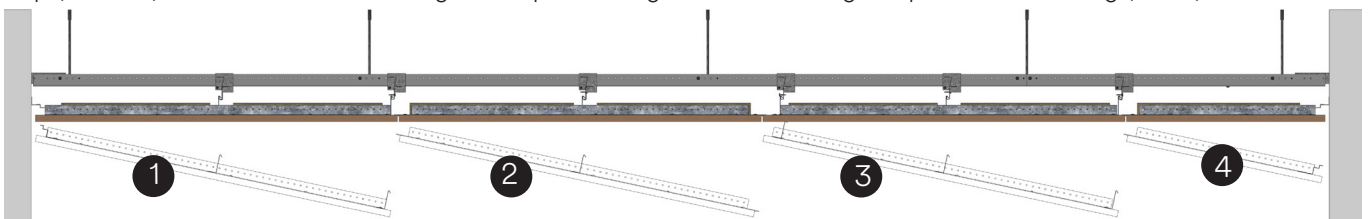

Each panel can be disassembled by lifting it slightly. The centre panels (2) must be opened first.

Photo 1

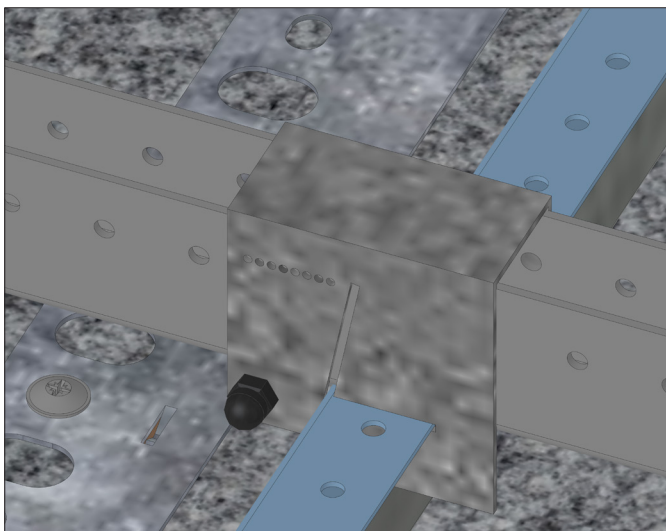
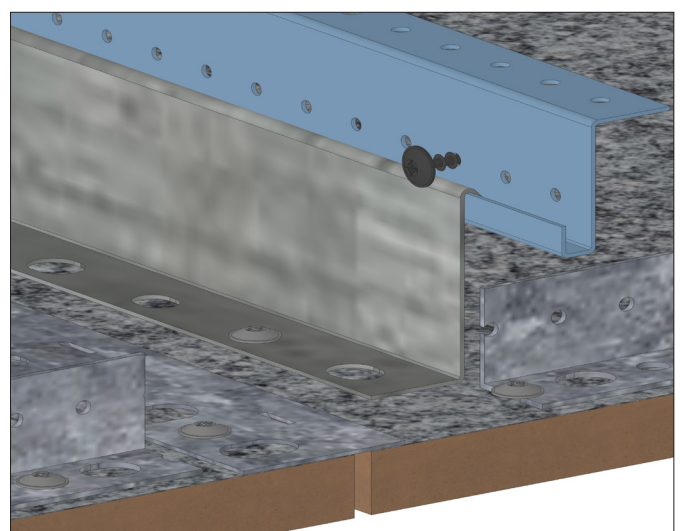
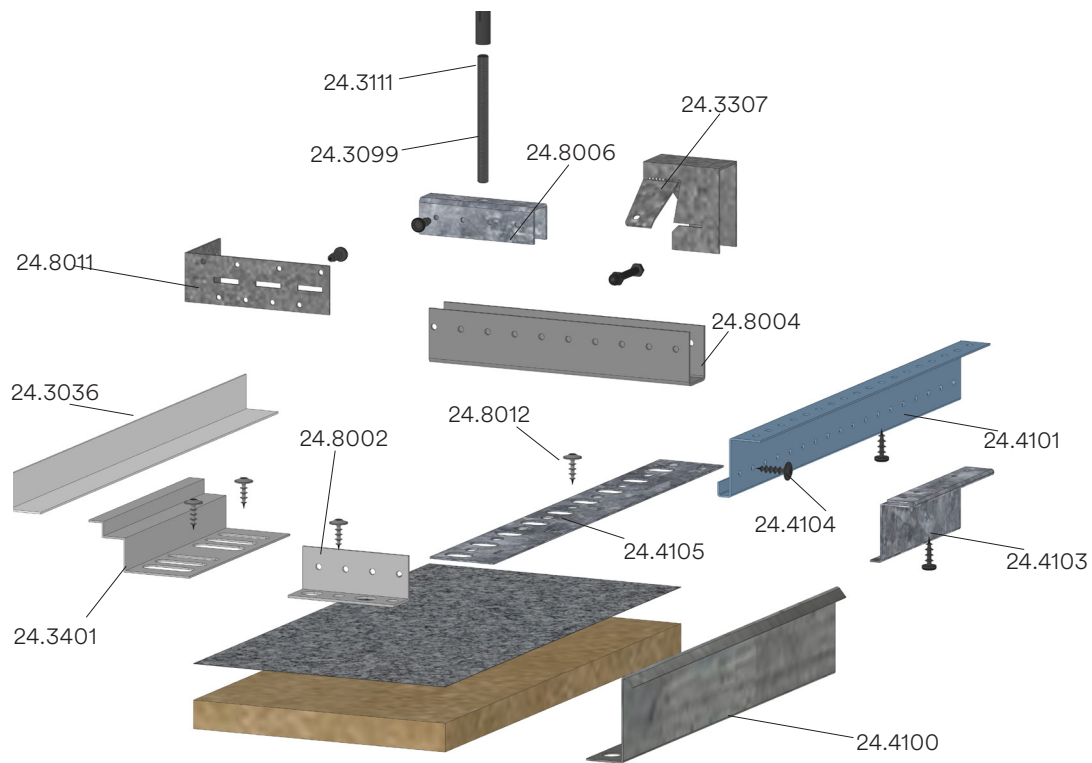
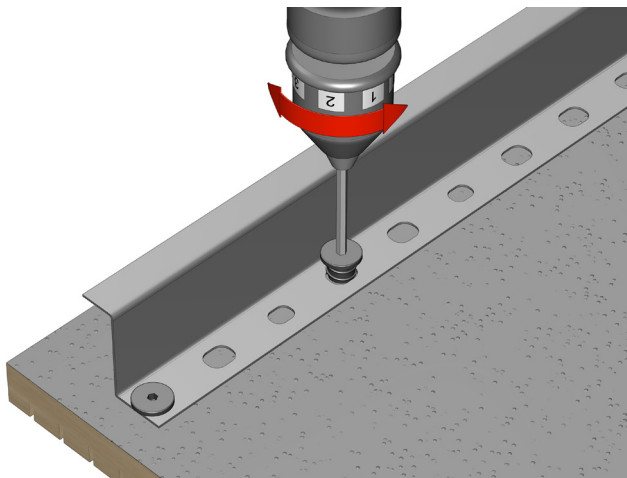

Photo 2





Installation information for screw joints



Design patterns:

The execution with off-set joints allows a small material dilation without it showing. The combination of a gap width of approx. 4 - 6 mm provides a clear and neat alignment.

English

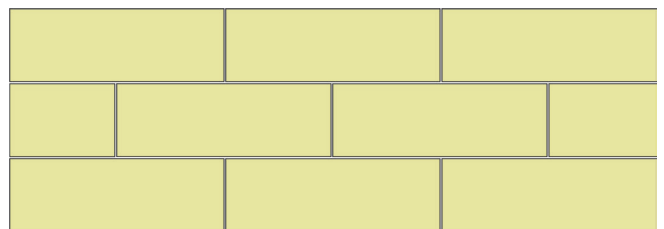

Parallel

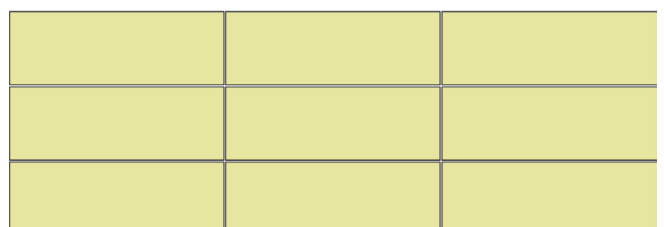

- Set correct torque
- Do not strip the thread
- At best try slug test

Please note:

The Topakustik mounting system documented on pages 37 + 38, with corresponding profiles and connectors, must be adhered to exactly in order to ensure a correct installation. For the installation of the panel and angle profiles, the screwdriver's torque must be adjusted accordingly so that the screws are not overtightened. Any warranty claims will be rejected if the instructions described here are not adhered to.

Torque screw 24.1010 = 1.9 Nm
 Max. torque screw 24.1009 = 0.9 Nm
 Max. torque screw 24.1008 = 1.9 Nm

G1 System for universal application

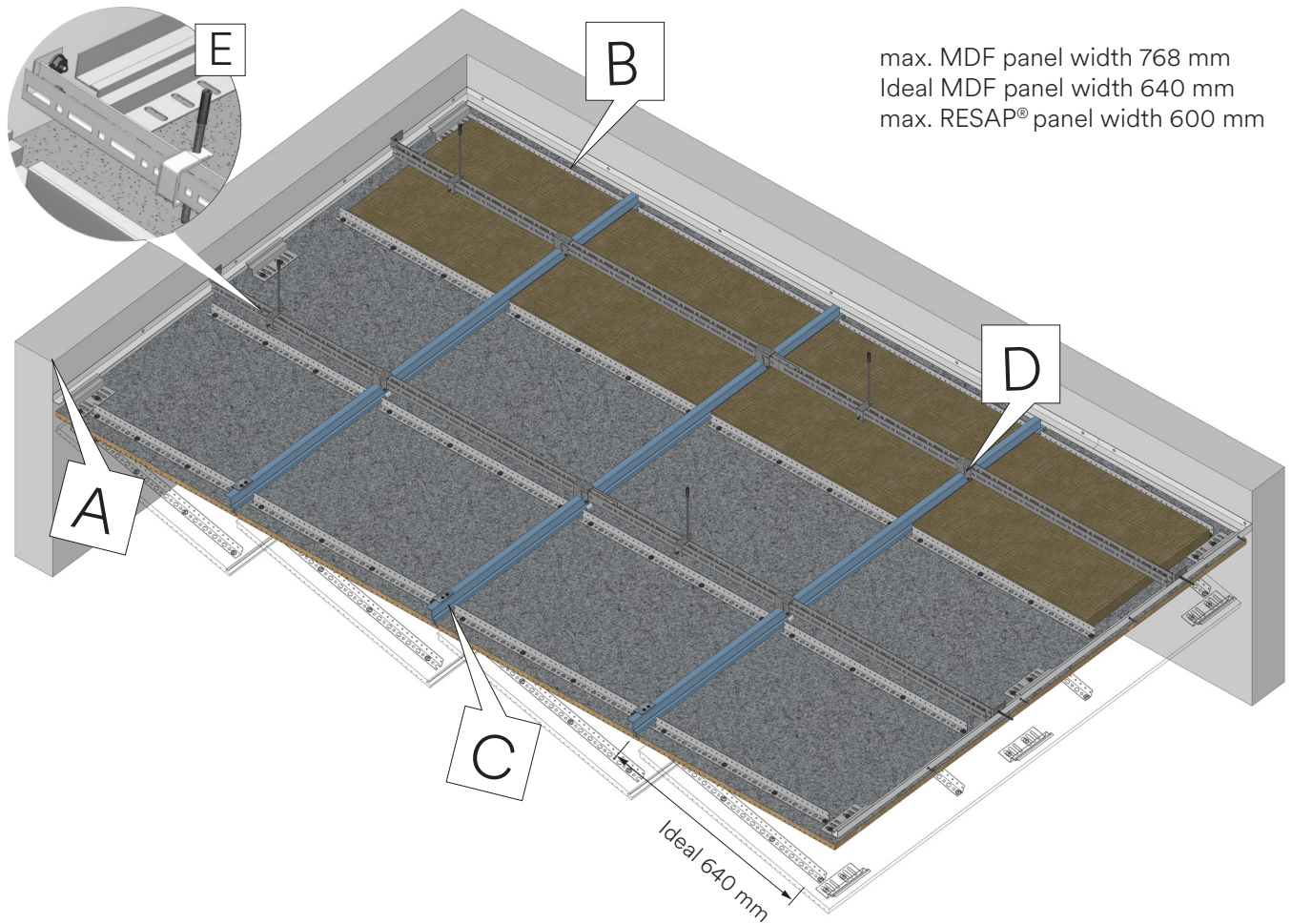

max. MDF panel width 768 mm
 Ideal MDF panel width 640 mm
 max. RESAP® panel width 600 mm

Wall connection

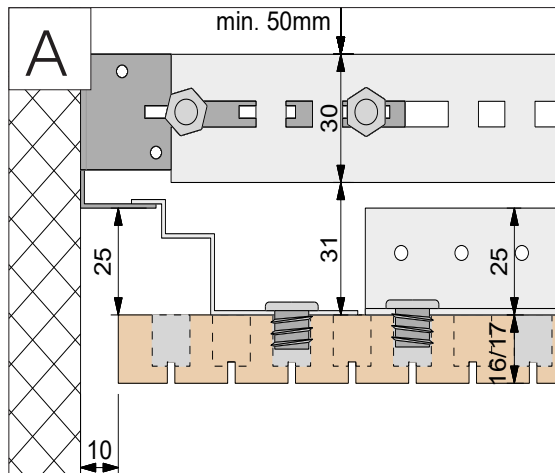

Butt joint typical detail

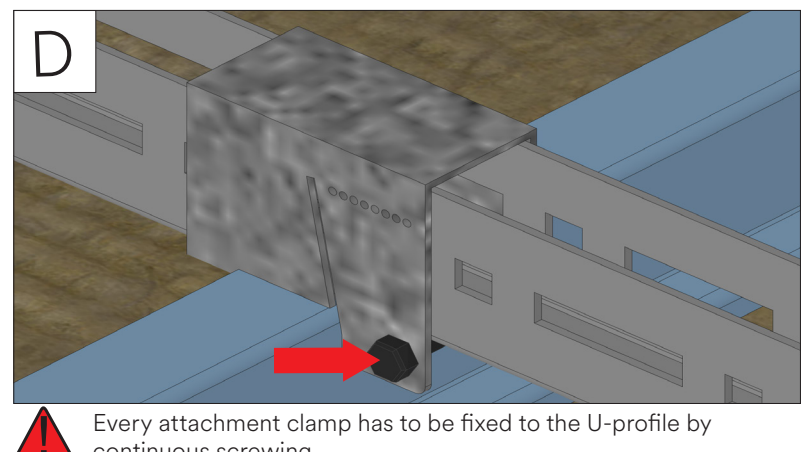
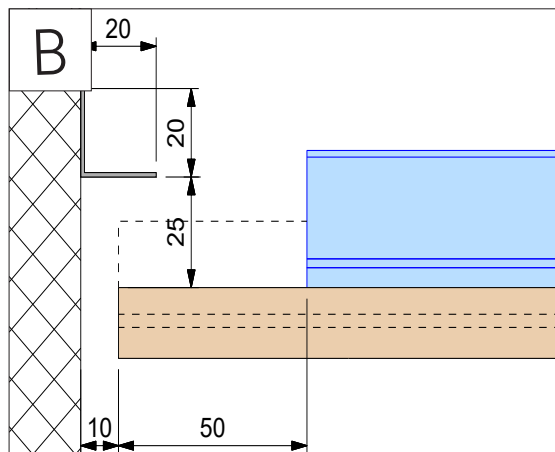
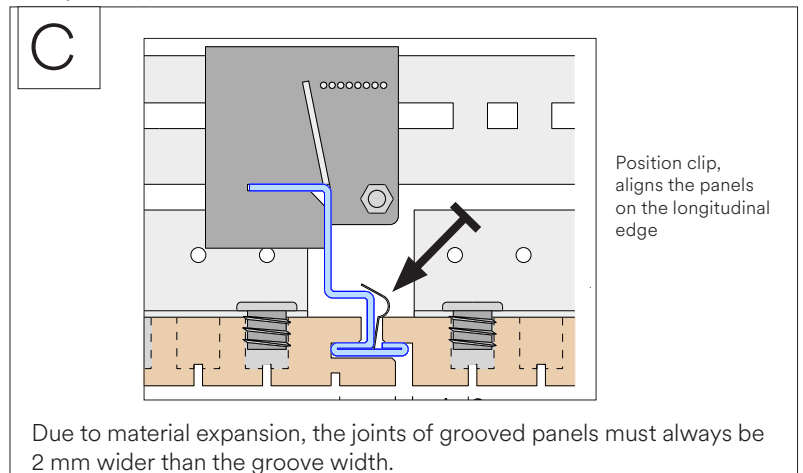

Every attachment clamp has to be fixed to the U-profile by continuous screwing.

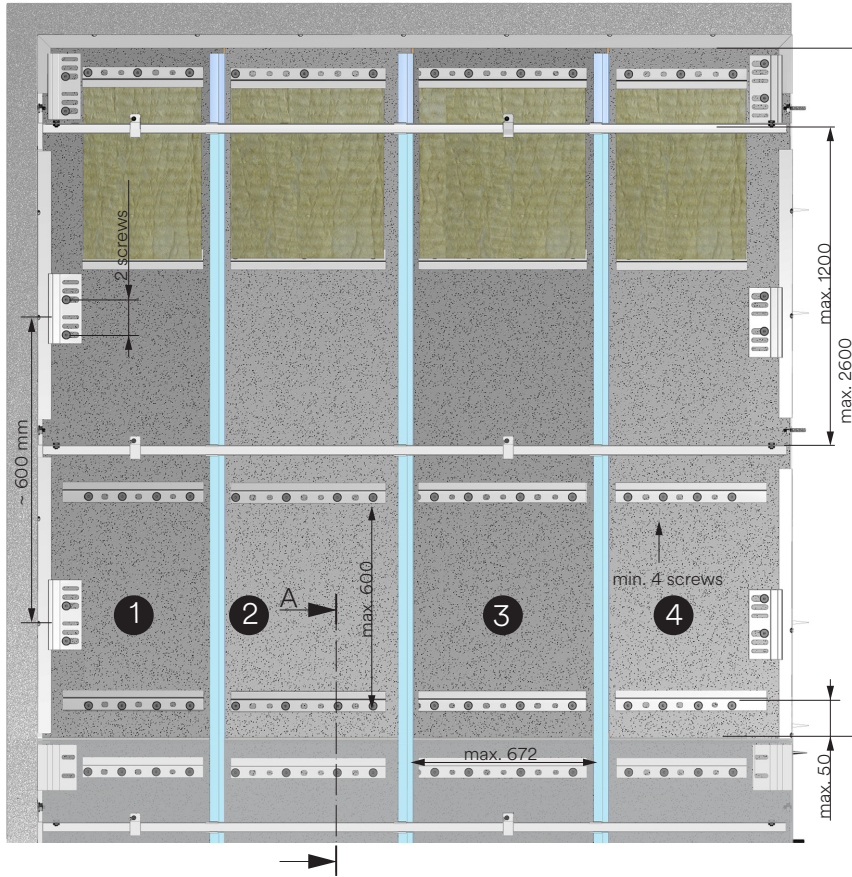

G-Profile

i Stiffen MDF panels at a distance of 500-600 mm with the L-profiles. Max. 50 mm from outer edge.

Stiffen RESAP® panels at a distance of 450-500 mm with the L-profiles. Max. 50 mm from outer edge.

The L-profiles are delivered in production lengths of 2,496 m, trimmed on site and permanently fixed by the patent screws into the perforation of the Topakustik panels.

! Stiffen counter grid diagonally. This avoids «Floating» of the ceiling construction.

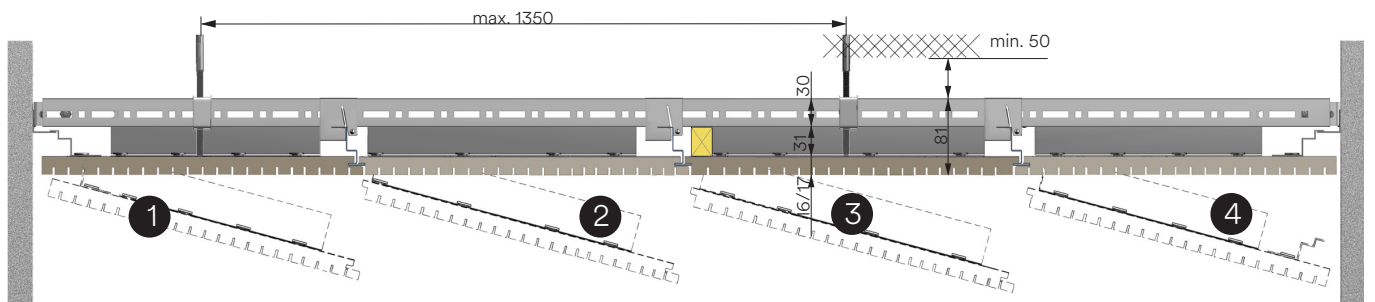
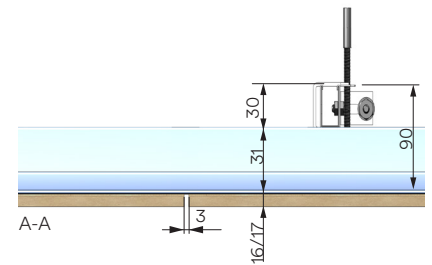

i With the Topakustik G System every panel can be removed easily by gentle lifting.

i The Topakustik panel in the G System can be secured by inserting a distance rail against lifting.

Transverse joint with blocking

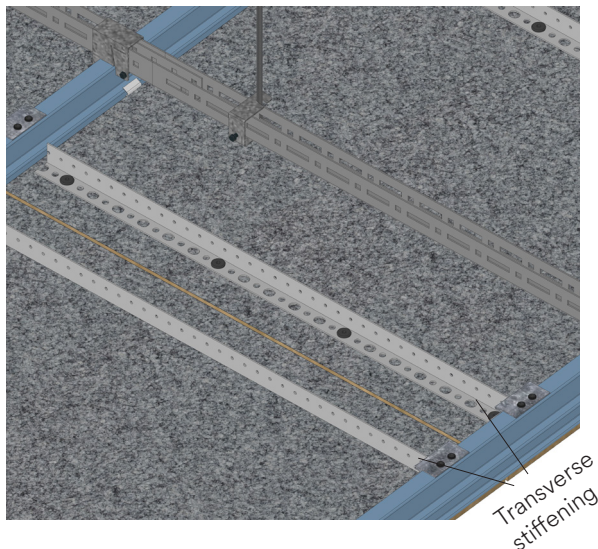

Type GEMAGRID

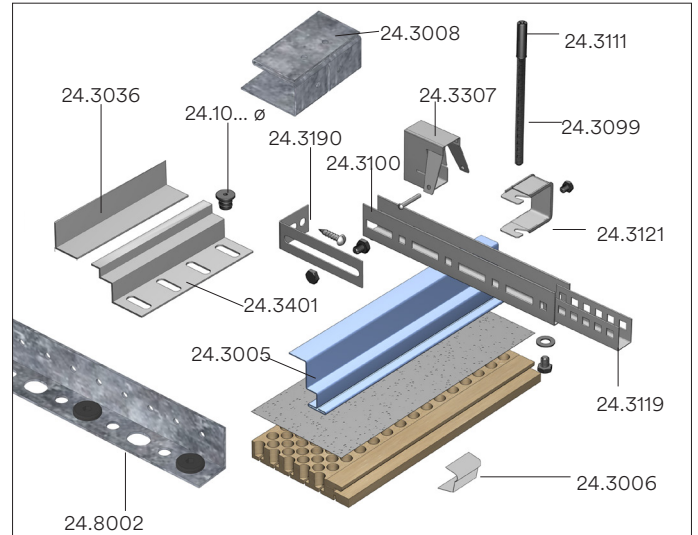

Panel with safety cord

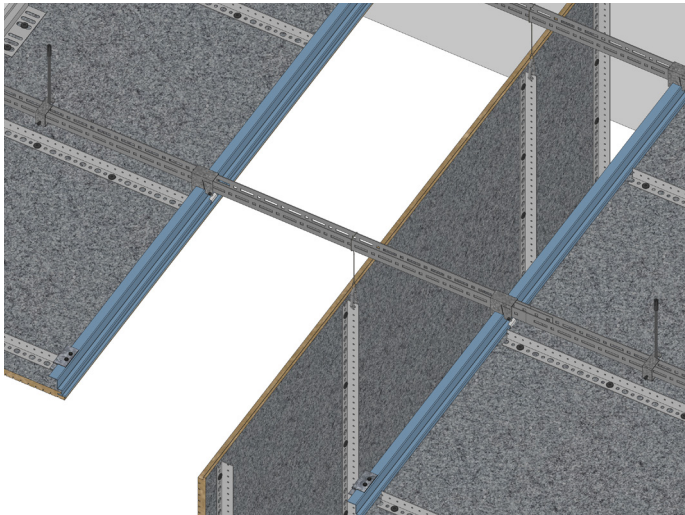

24.3403 Safety wire rope with snap-hook for panel weight up to 40 kg with 2 cords

Installation information for screw joints

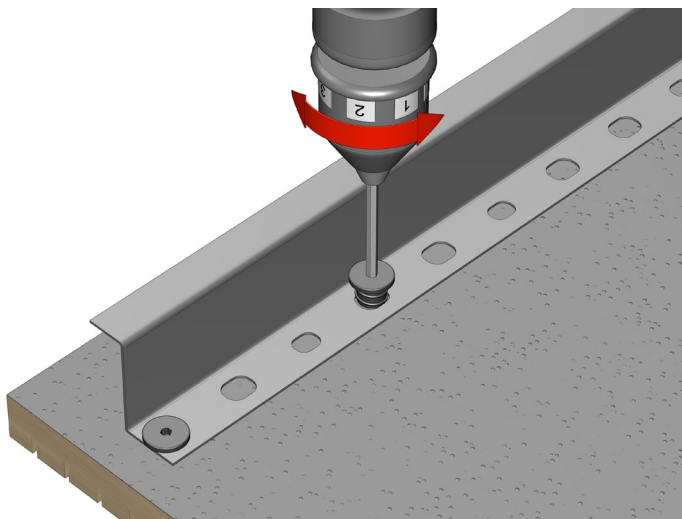

- Set correct torque
- Do not strip the thread
- At best try slug test

Torque screw 24.1010 = 1.9 Nm
 Max. torque screw 24.1009 = 0.9 Nm
 Max. torque screw 24.1008 = 1.9 Nm

Please note:

The fixing system with G-profiles and the U-primary grid documented on pages 40 - 41 is checked for a professional installation with Topakustik panels. For installation of the G-profiles on the Topakustik panels, the torque has to be set correspondingly, so that the threads are not stripped. For non-compliance to the information described here any liability is refused.

Design patterns:

The execution with off-set joints allows a small material dilation without it showing. The combination of a gap width of approx. 3 - 6 mm provides a clear and neat alignment .

English

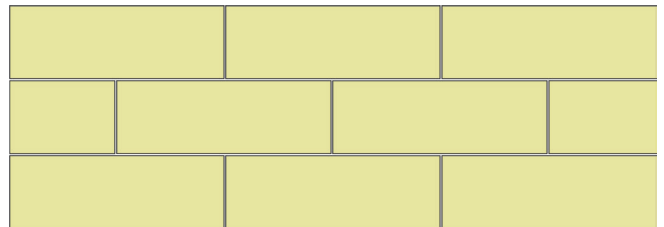

Parallel

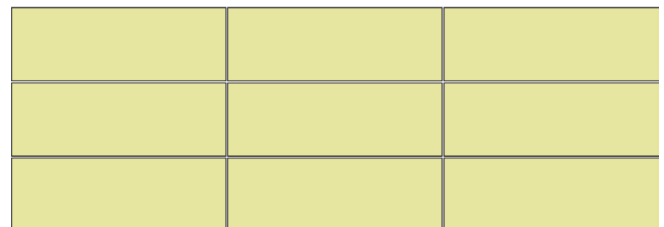

Parallel assembly only possible with longitudinal clip 24.3008.

G1 / G2-System - longitudinal clip

The longitudinal clip no. 24.3008 prevents lengthwise movement by the acoustic panels. This clip is secured to the G profile using a metal screw and clamps the angle profile no. 2.24.8002. The system's access function remains the same as before.

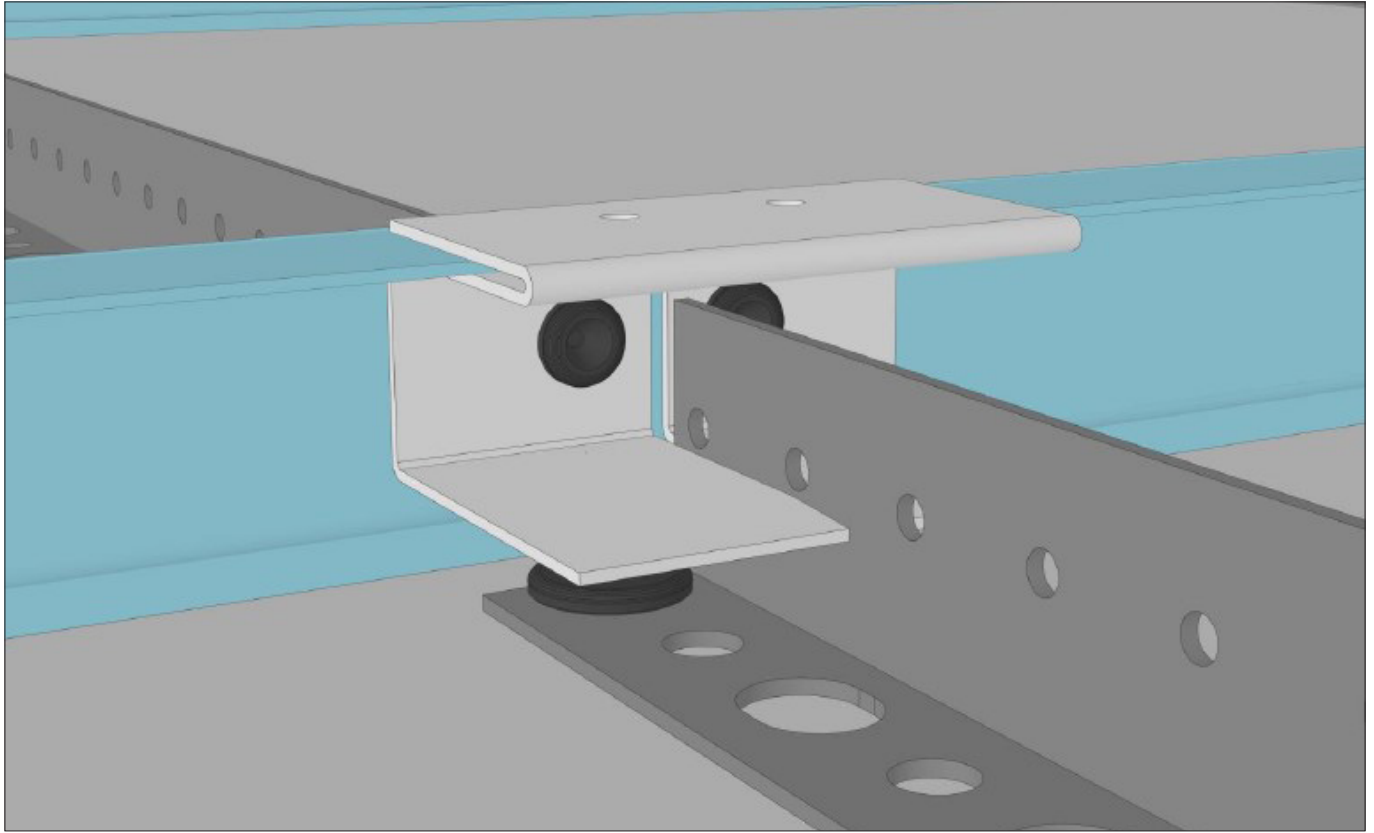

Detail wall installation with clip

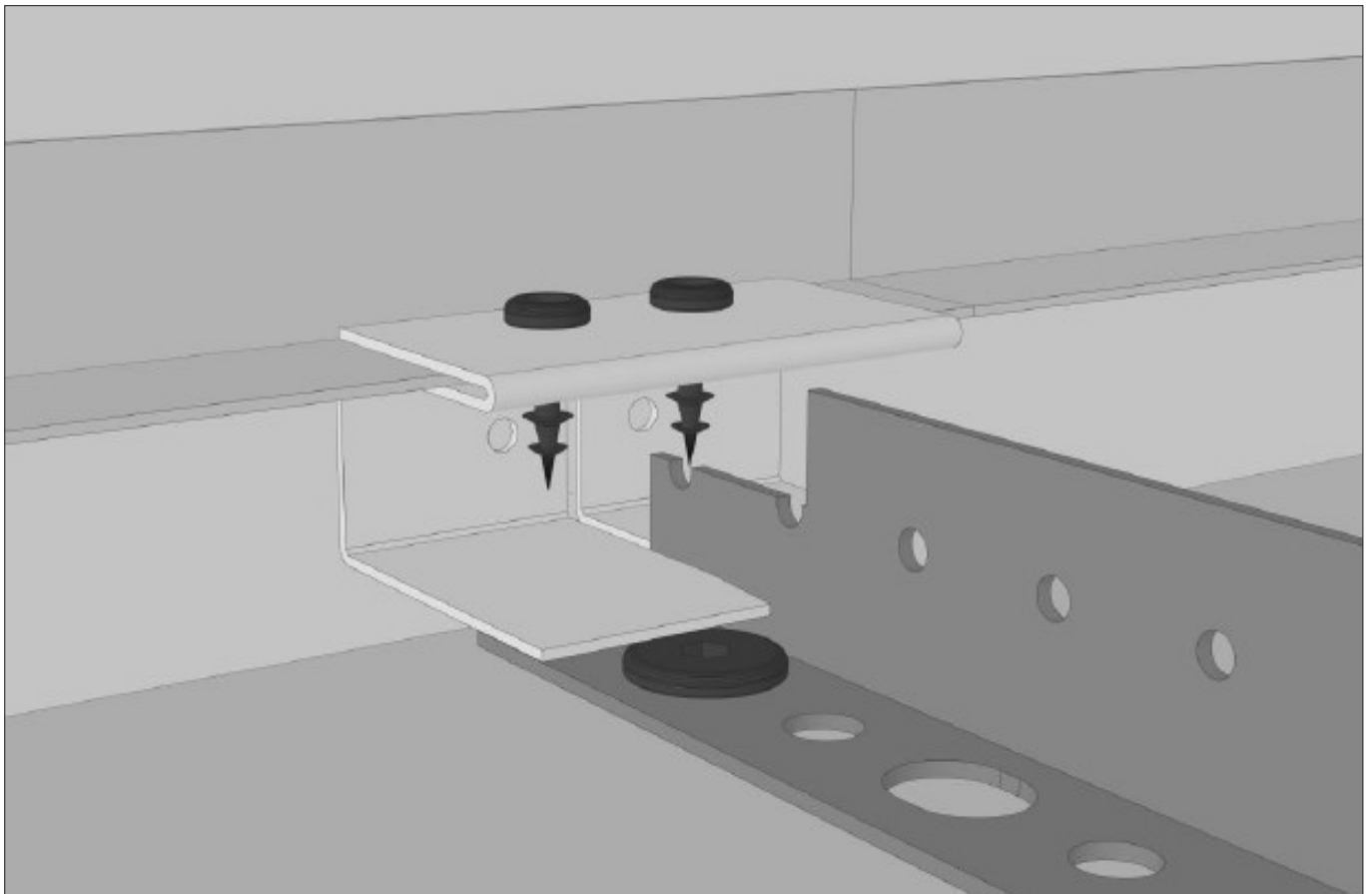

G2- System for universal application - Sukow + Fischer Type 108

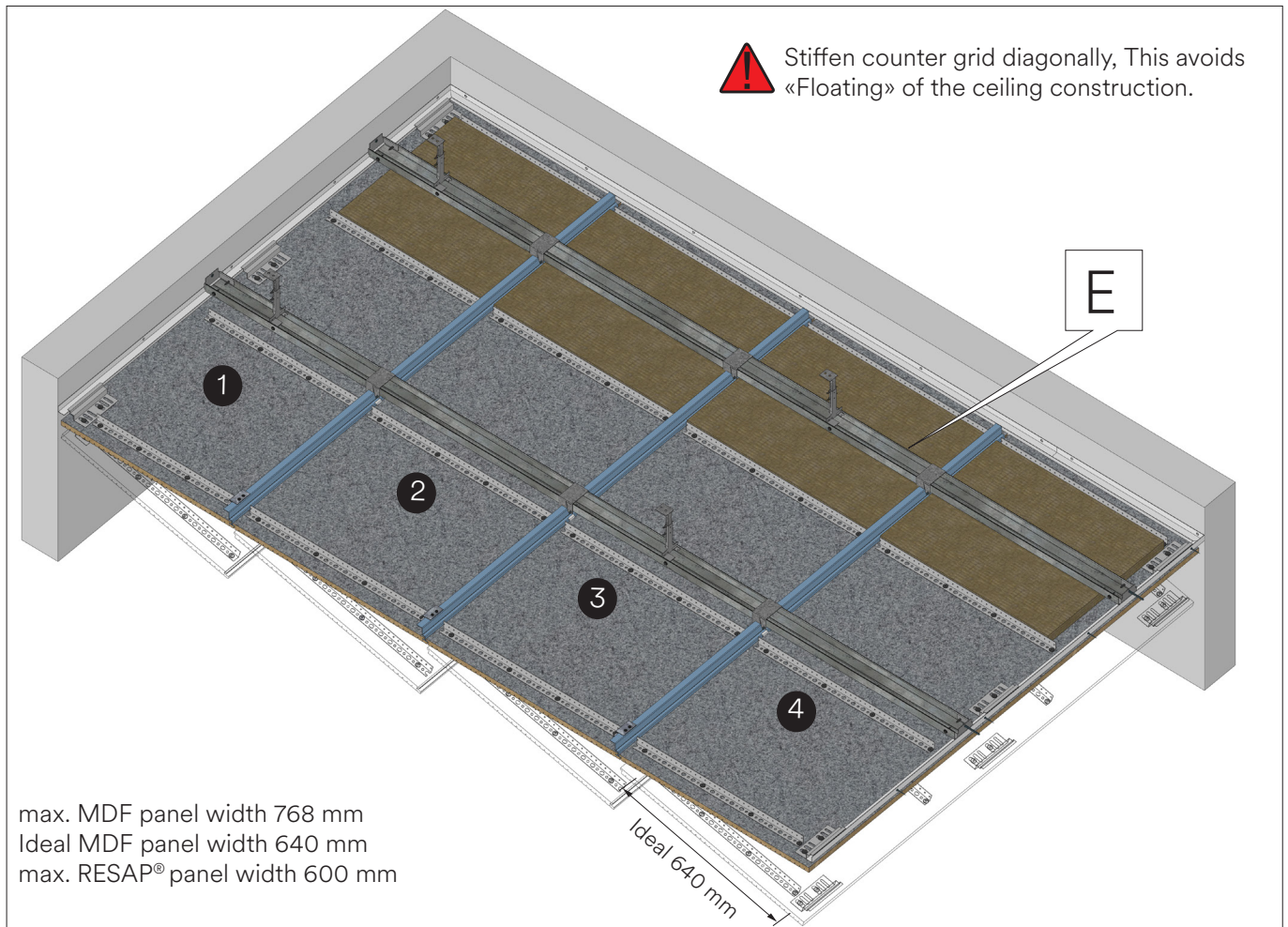

Type Suckow + Fischer Type 108

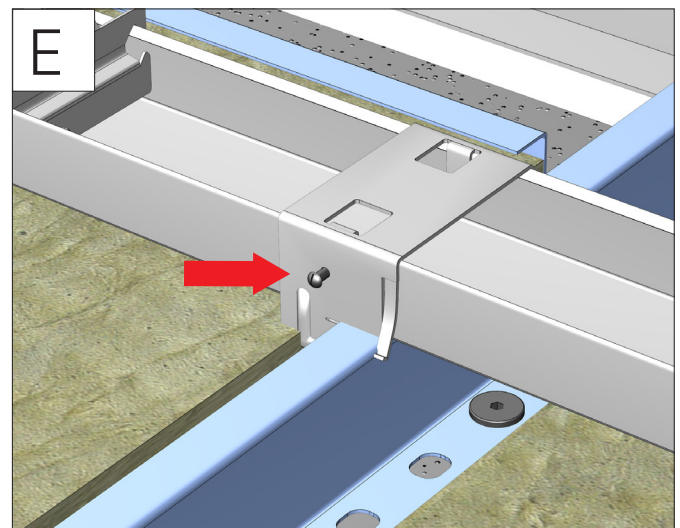
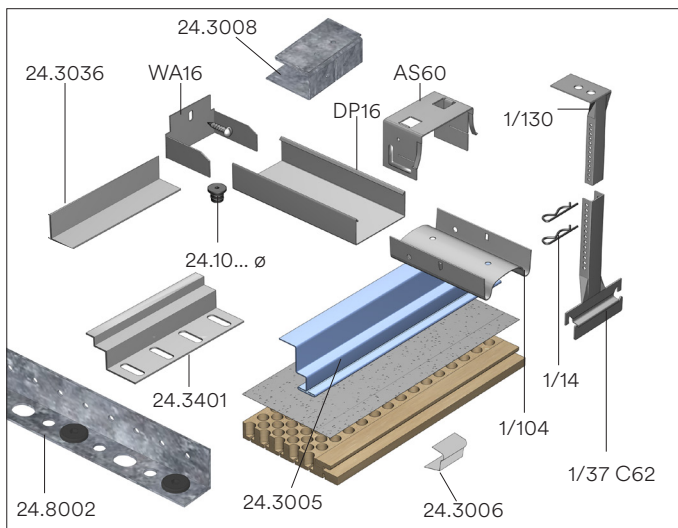

 All attachment clamps have to be fixed to the DP16 profile.

Please take the other details for this system from pages 40 - 43.

S11 System for removable ceiling panels

The S11-System is a ceiling construction where each panel can be removed separately. The panels are fixed with steel springs and safeguarded against falling (earthquake-safe). The entire construction consists of galvanized steel profiles.

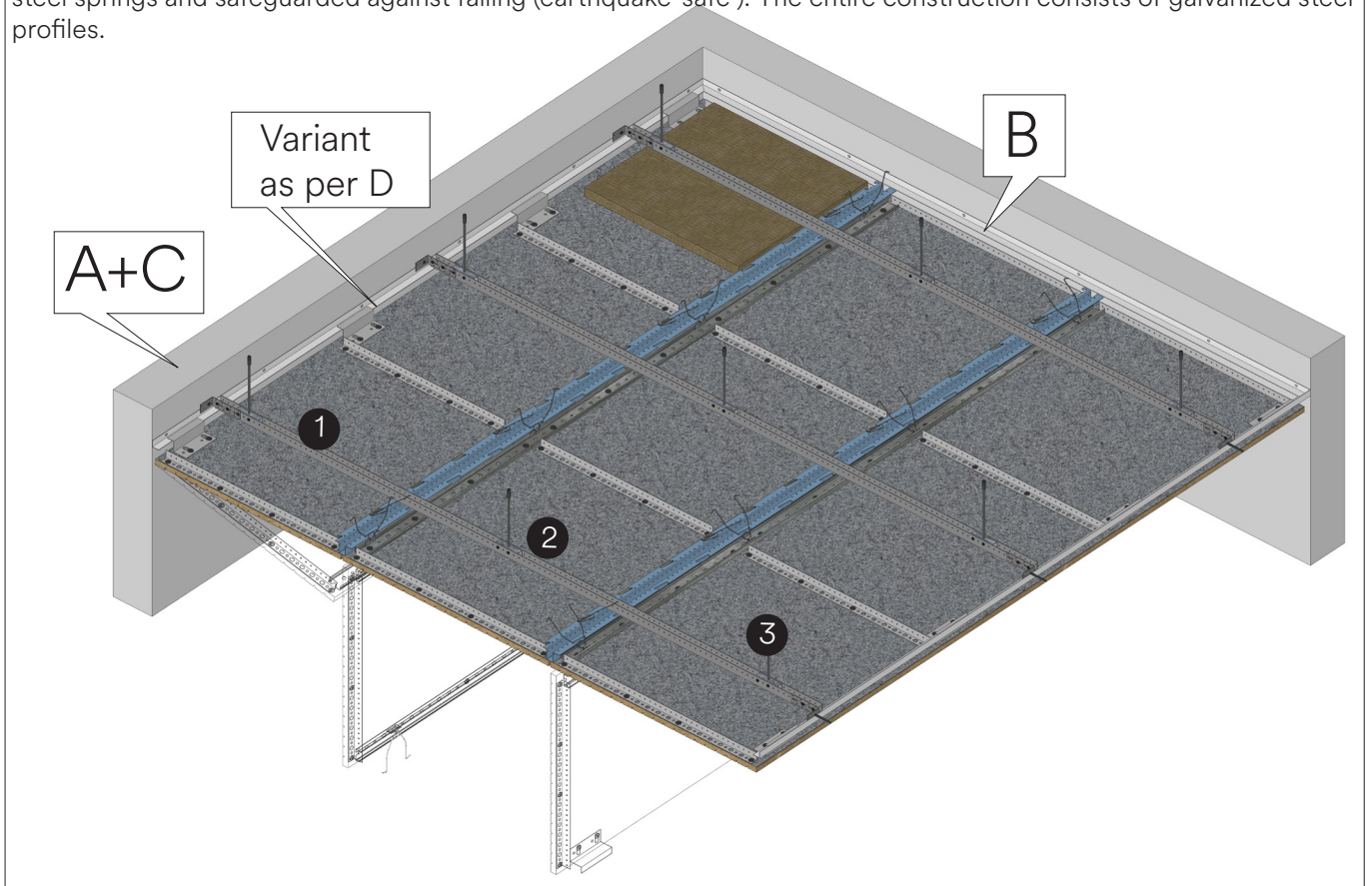

Wall connection with support bracket and safety cord

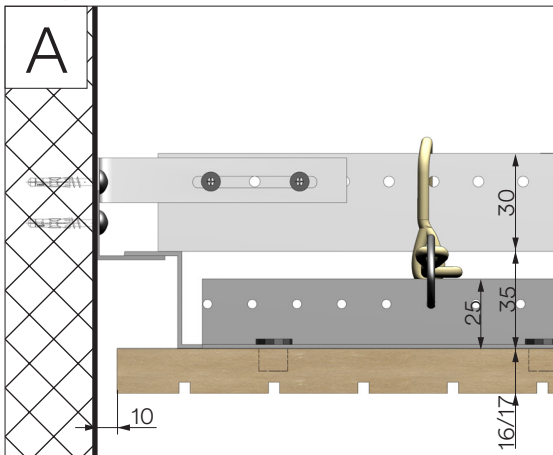

Wall connection with support bracket

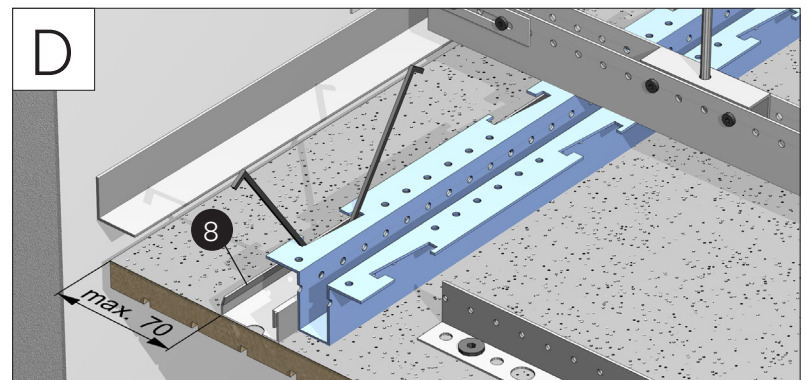
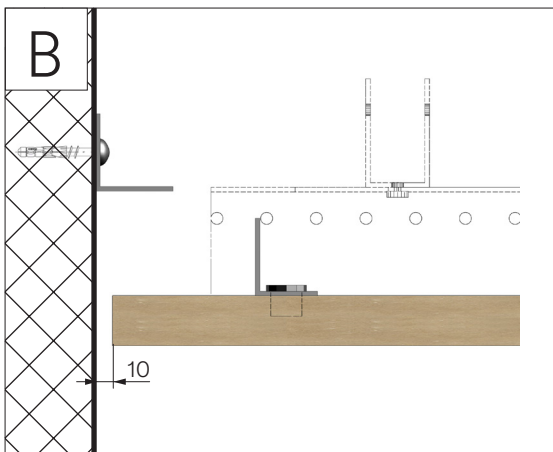
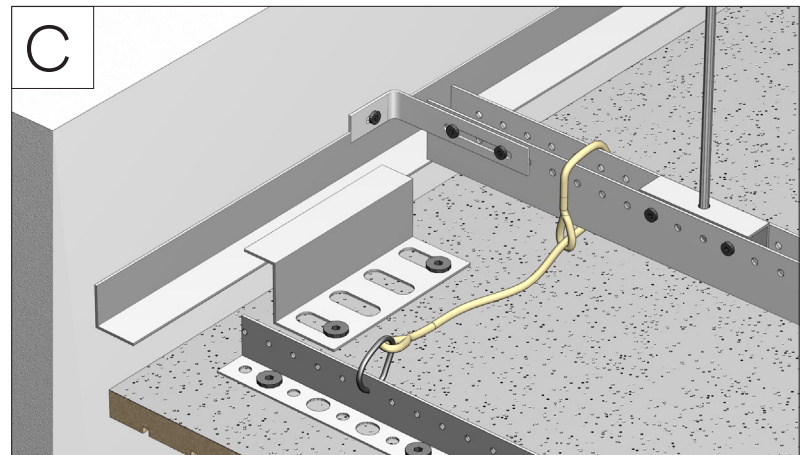

Variant: For wall connection the panels can also be mounted with a cap profile instead of the support bracket (as per details A + C).

S11 System supporting construction

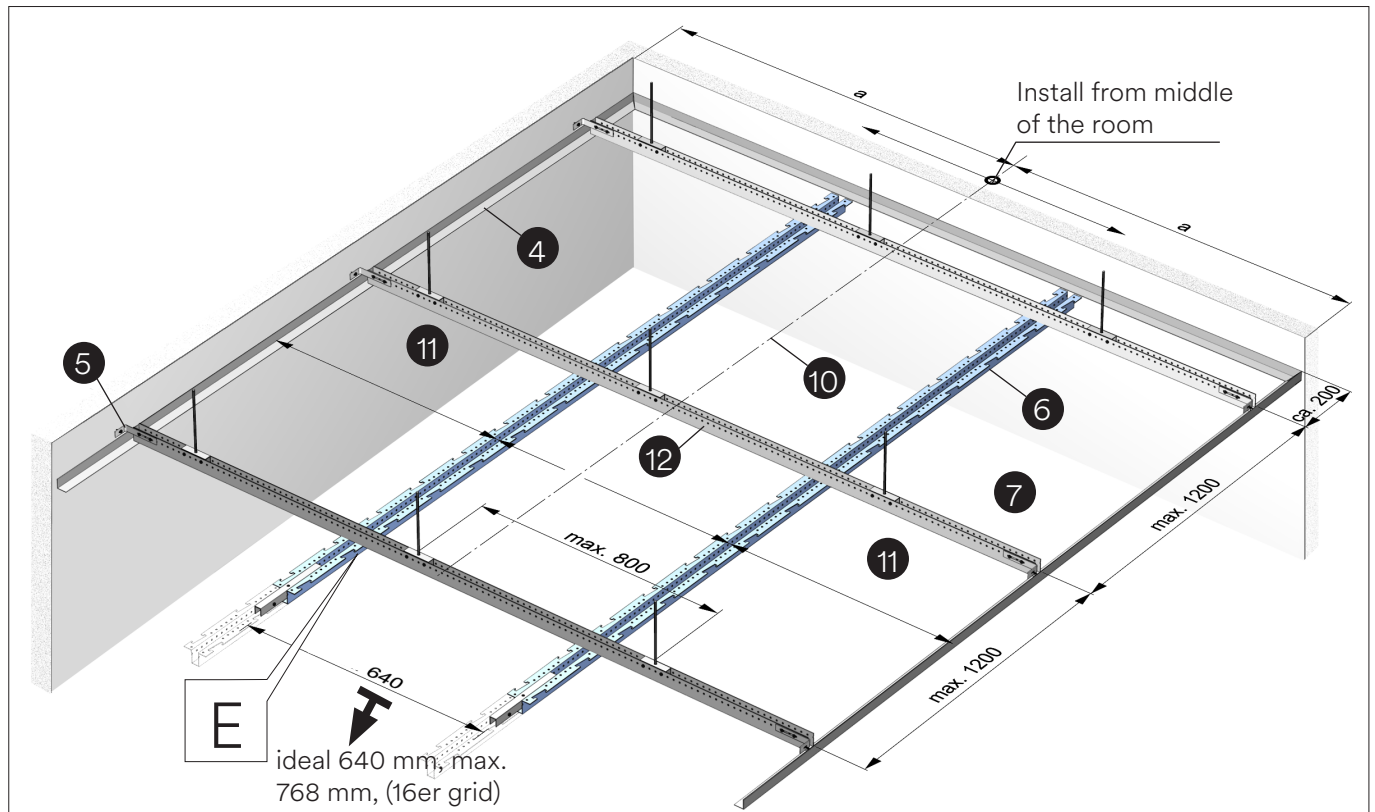

Ceiling panels with mounting profiles and transverse reinforcement, prepared for installation.

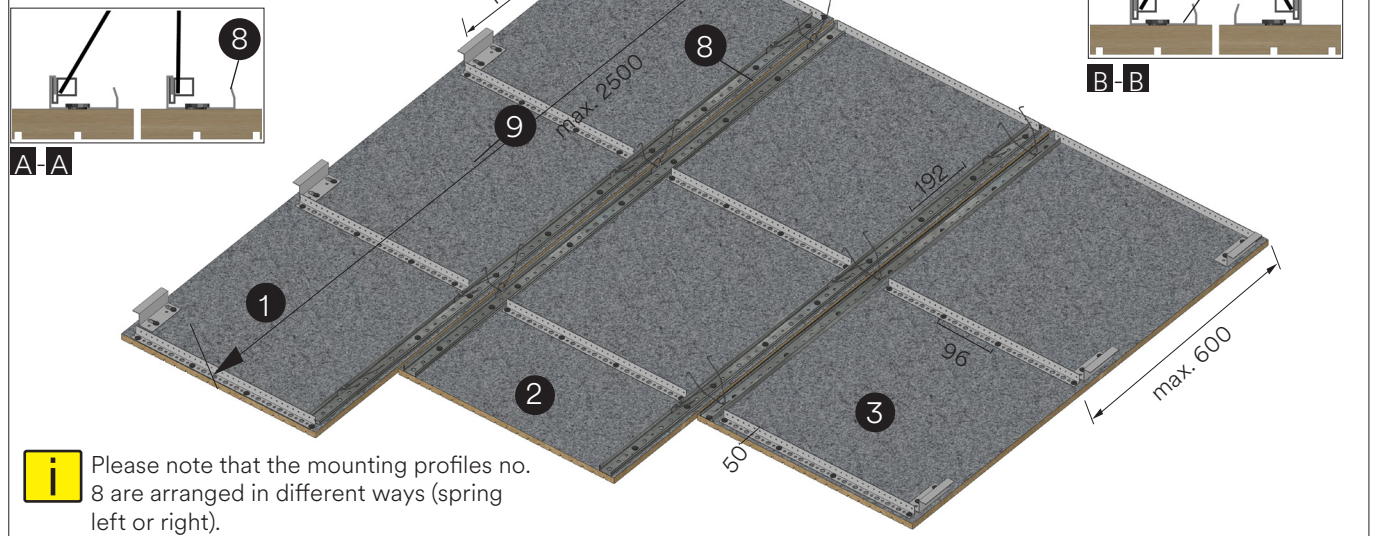

Screw connection between cap profile and ceiling grid

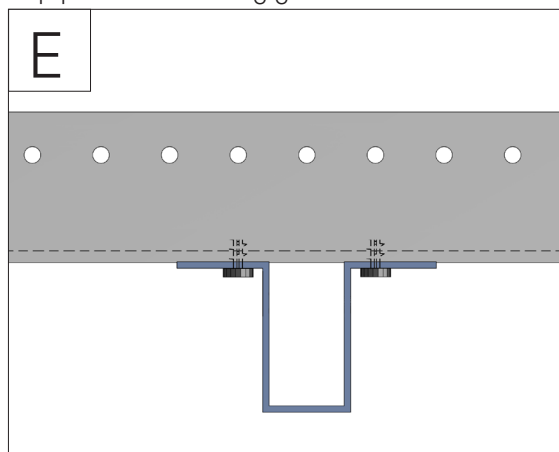

Transverse and longitudinal butt joint

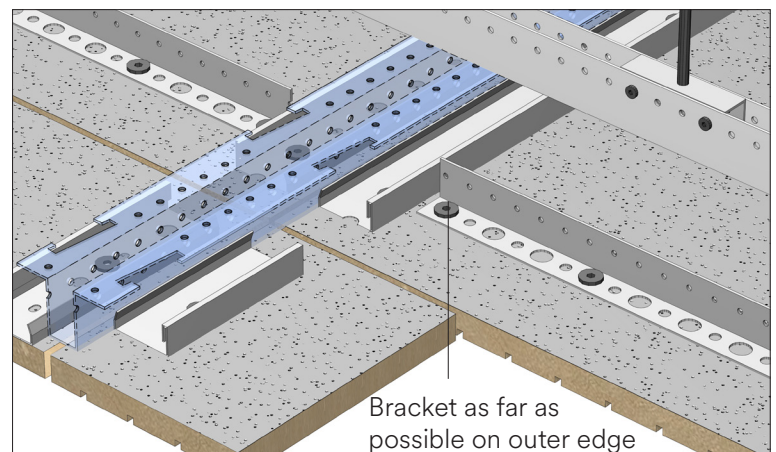

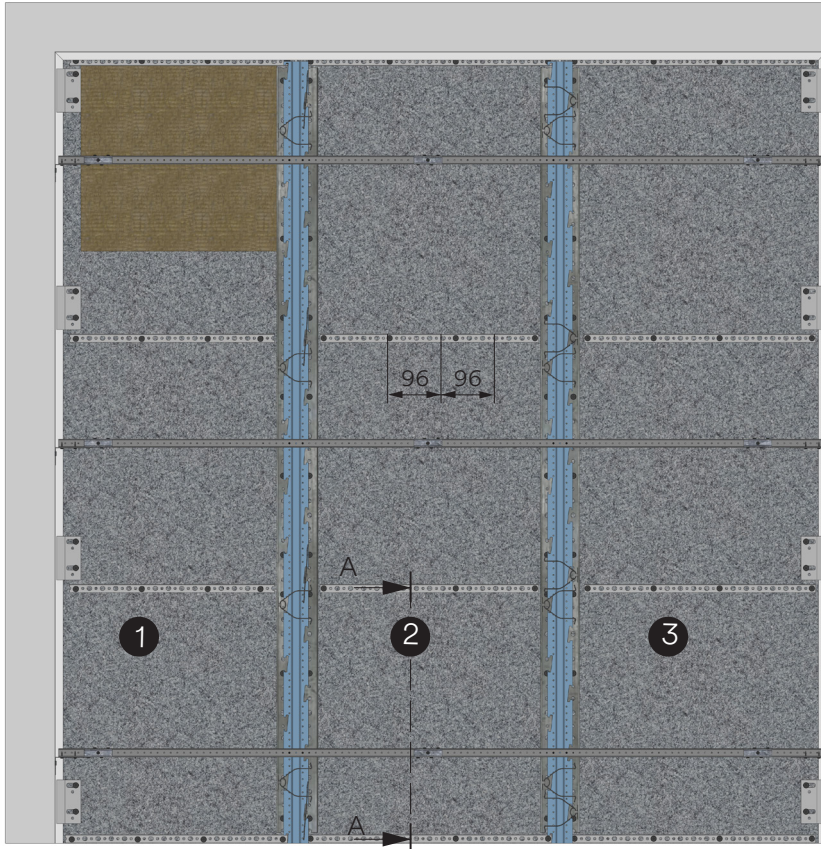

Angle profiles (9)

 Stiffen MDF panels at a distance of 500-600 mm with the L-profiles. Max. 50 mm from outer edge.

Stiffen RESAP® panels at a distance of 450-500 mm with the L-profiles. Max. 50 mm from outer edge.

The angle profiles are delivered in production lengths of 2,496 m1, trimmed on site and permanently fixed by the patent screws into the perforation of the Topakustik panels.

 Diagonally brace counter-grid. This prevents the ceiling construction from «floating».

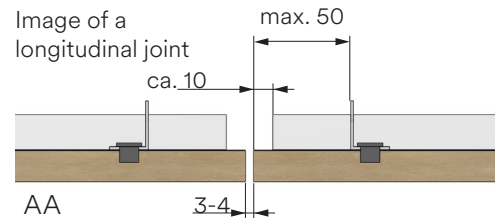

Torsion springs:

- Distance between the springs on MDF boards = ~600mm,
- Distance between the springs on RESAP® boards = ~450mm

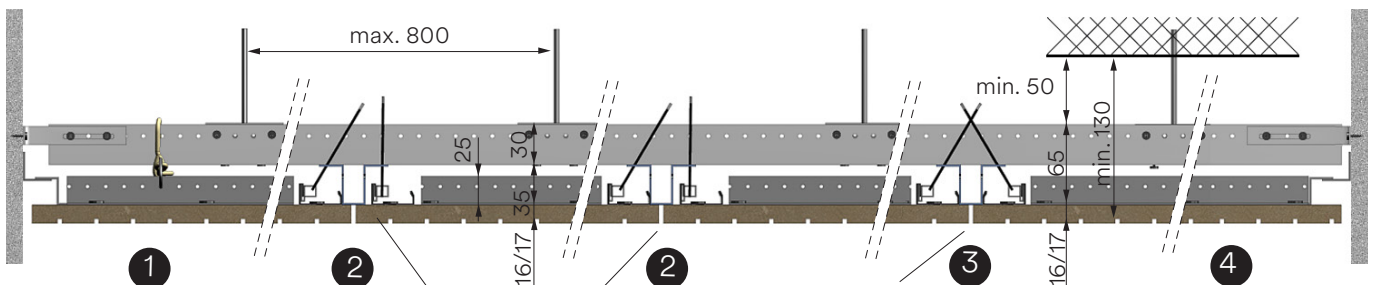

Joint size min. 4 mm,
Due to material expansion, the joints of grooved panels must always be 2 mm wider than the groove width.

Cross-bracing with butt joint

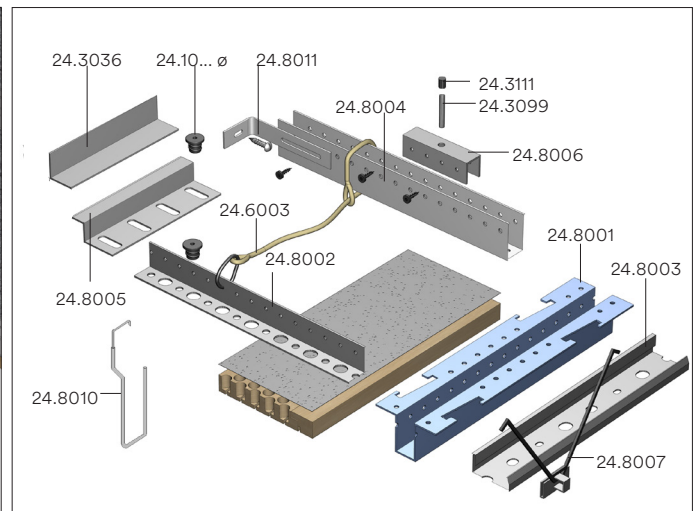
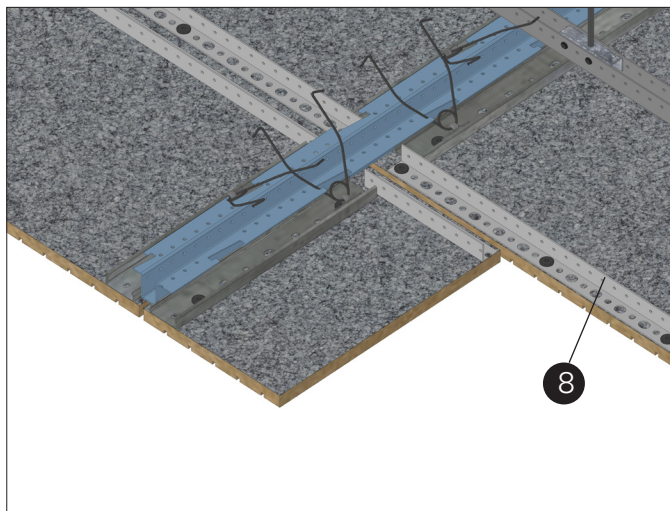

Mounting instructions for screw connection

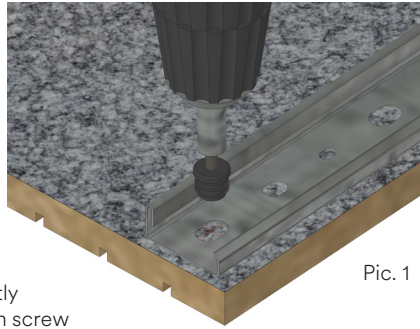

Pic. 1



- Set torque correctly
- Do not overtighten screw
- If necessary, check tightness of connection manually

Place screw in the middle of the slit due to dilation.
Tighten screw only lightly.

Torque screw 24.1010 = 1.9 Nm
Max. torque screw 24.1009 = 0.9 Nm
Max. torque screw 24.1008 = 1.9 Nm

Please note:

The attachment system documented on pages 45-47 using angle and cap profiles and the U primary grid has been certified for professional installation with Topakustik panels. When mounting the angle profiles onto the Topakustik panels, the torque on the power screwdrivers must be set accordingly to prevent the screws from being over-tightened. All warranty claims are rejected if the instructions given here are not complied with.

Layout types:

Layouts with offset joints more desirable to allow for material expansion and contraction with minimal visual impact. When combined with joint widths of approx. 3 - 6 mm the visual appearance is clean and consistent.

Englisch

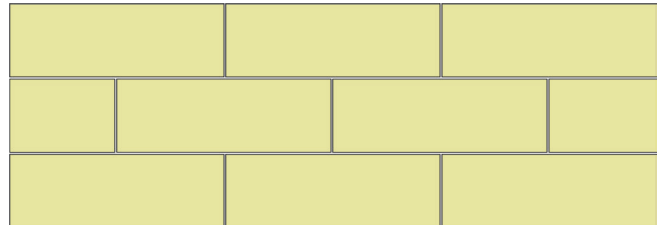

Parallel

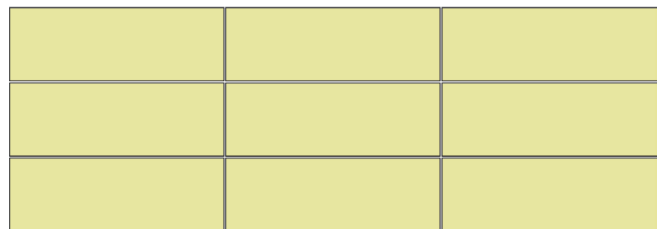

Mounting the Topakustik Panel System S11

Step 1

Check room size and angles, are the walls parallel or conical?

Determine ceiling height. Maintain a space of at least 130 mm from the lowest point of the raw ceiling or lines/cables to the lower edge of the visual ceiling.

Step 2

Mount the edge bracket (4) at the corresponding height.

Step 3

Determine the dimension between axes (10) of the room width, dimension (a) should be equal on the right and left-hand side.

Step 4

Determine position and height of the counter-grid (space max. 1,200 mm). Determine space of the threaded rods and mount. Attach counter-grid to the threaded rod. cap profile (6) under counter- Tightly screw the grid. The space between the counter-grid (12) No. 1+3 is determined based on the panel width. The perforated grid of the profiles is 16 mm and made to fit the Topakustik panels. Align cap profile spaces (6) with the side walls.

Step 5

Cut all longitudinal (8) and transverse (9) profiles as specified on page 45 and then screw into panels.

Step 6

Glue insulation onto rear of panels.

Step 7

Mount ceiling panels starting from middle, and continue to the left and right. Suspend panels by compressing the spring and insert laterally as shown in Pic. 5 + 6.

Variant on Step 7

Instead of the support angle, the wall connection panels can also be mounted with the cap profile as shown in Pic. D, page 45.

Step 8

Wall Plate - Panels. No. 1 + 3

Determine the dimensions of the wall connection panels cut wall connection panel to correct width, mount support bracket and cord. Mount ceiling panels.

Panel S11 System opening



Pic. 2

Insert offset handle into the butt joints at the panel corners as shown in Pic. 2. and rotate 90°.



Pic. 3

Pull ceiling panel downwards using the offset handle as shown in Pic. 3 until your hand fits into the opening.



Pic. 4

Pull ceiling panel down along the entire length, as shown in Pic. 4 (approx. 100 mm) until the element rests on the spring clip.



Pic. 5

Then pull down on the other long side as shown in Pic. 5 until the entire panel is suspended horizontally from the spring clips.



Pic. 6

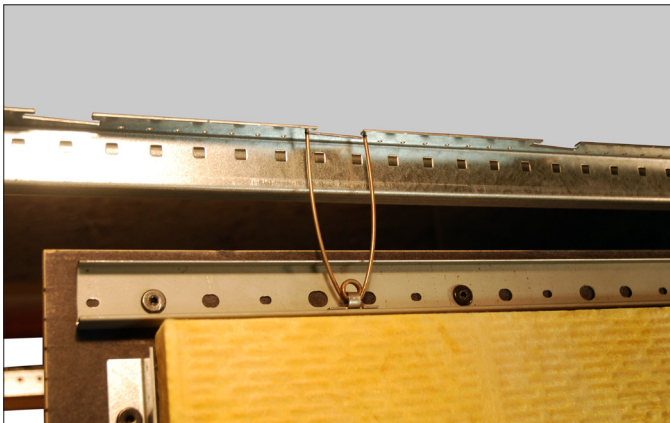

Pic. 7

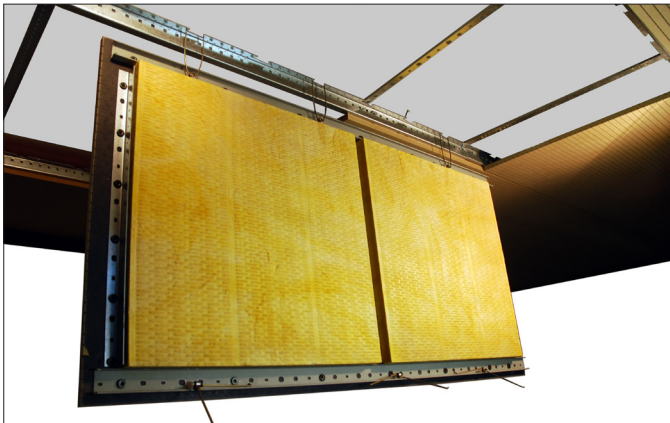

Pic. 8

Folding down the ceiling panel. Disengage spring clips on one long side as shown in Pic. 6 + 7 (squeeze together) so that the element can be folded down.

Let panel hang from the spring clips on one long side, as shown in Pic. 8. Extremely simple handling in the event of revisions or when installing additional cables/lines.

Sixty-System 120/60

The substructure must be installed according to the manufacturer's instructions. Additionally, the load-bearing capacity of the system must be checked before beginning installation.

RESAP® panels = approx. 22 kg/m² (incl. mineral wool)

MDF panels = approx. 14 kg/m² (incl. mineral wool)

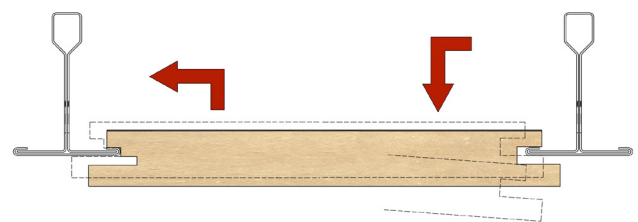
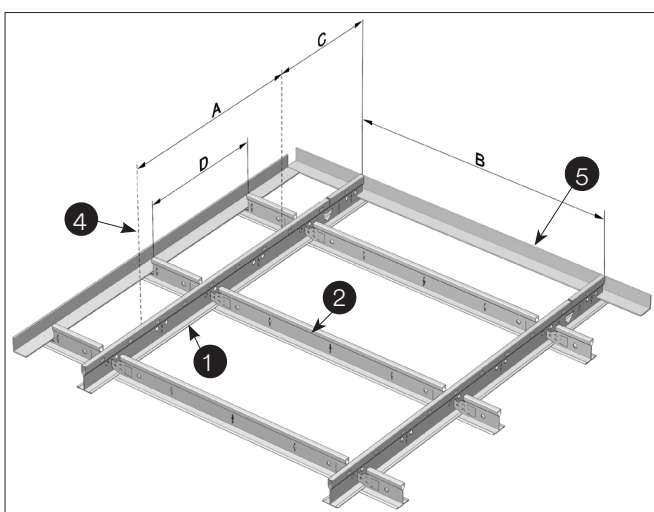
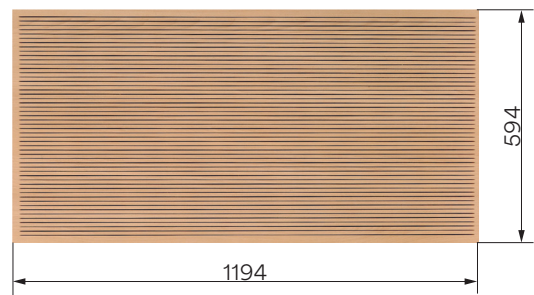
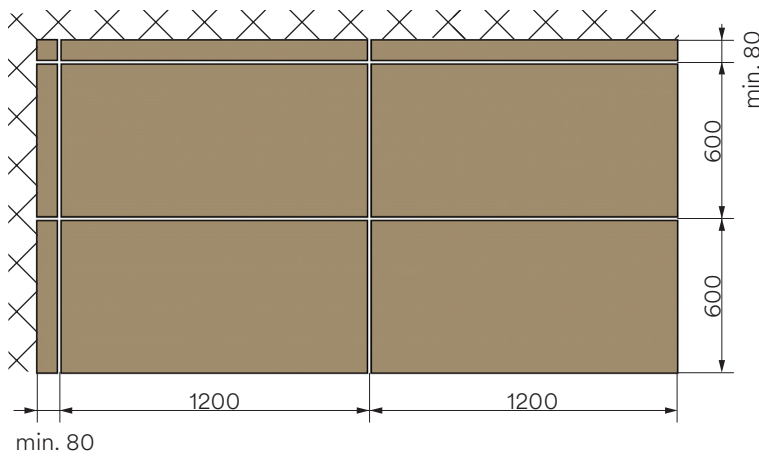
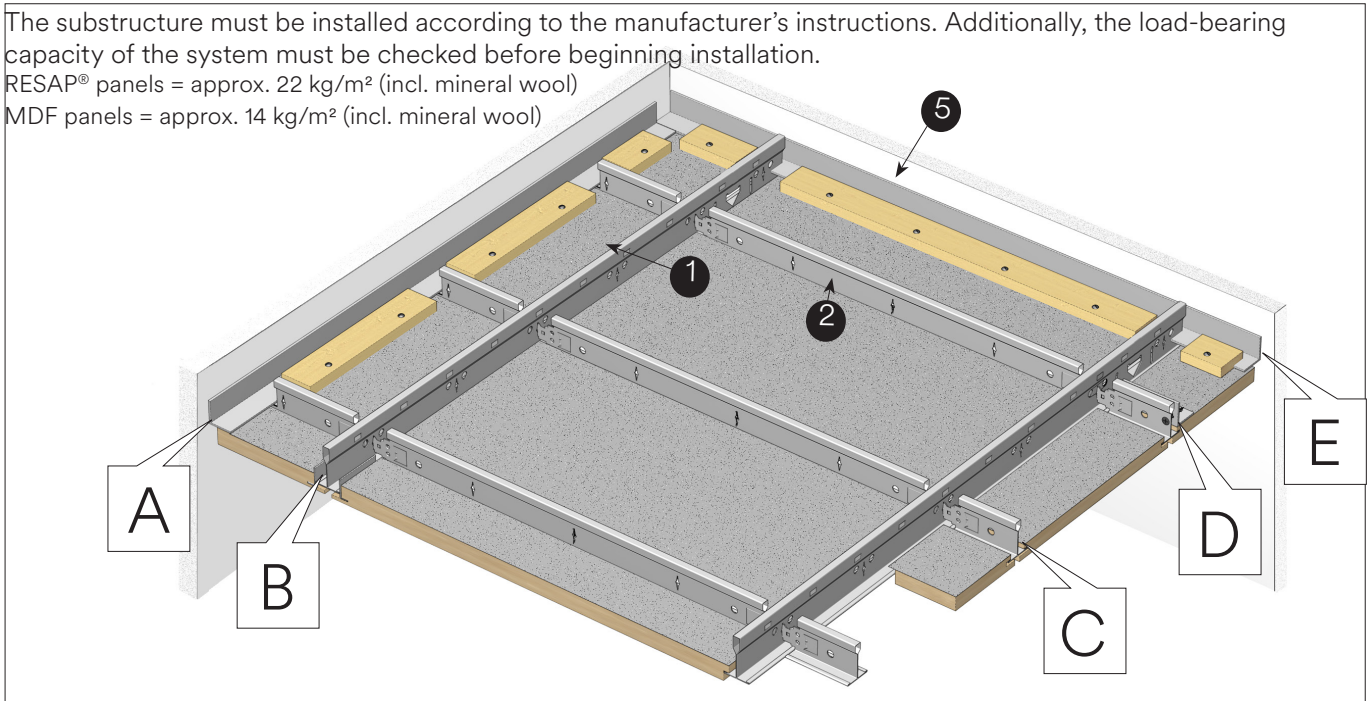

Sign: Space (mm)
 A 1200 Standard
 B 1200
 C max. 400
 D 600

Materials required for the Donn DX24 substructure (per m² of ceiling area). All specifications are approximate values without cuttings.

No.	Description	Item designation	Module 600 x 1200
1	Bearing rail	DX24 XH 370	0,83 m
2	Cross-rail, long	DX24 XM 120	1,67 m
4	Suspending bracket		0,70 piece
5	Wall bracket		depends on room dimensions (approx. 0.4 running meters/m ²)

Sixty-System 60/60

The substructure must be installed according to the manufacturer's instructions. Additionally, the load-bearing capacity of the system must be checked before beginning installation.

RESAP® panels = approx. 22 kg/m² (incl. mineral wool)

MDF panels = approx. 14 kg/m² (incl. mineral wool)

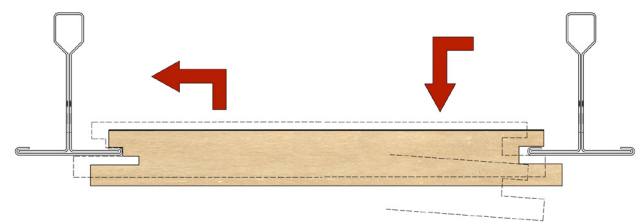
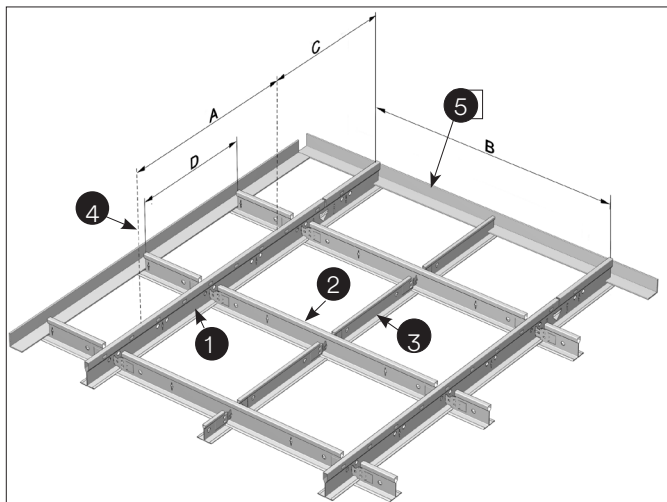
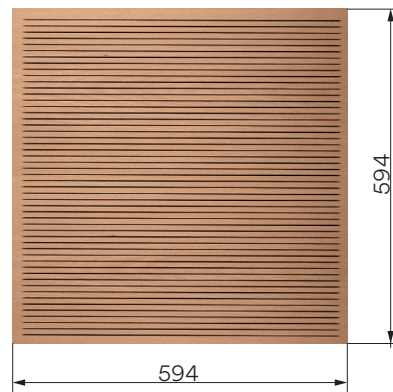
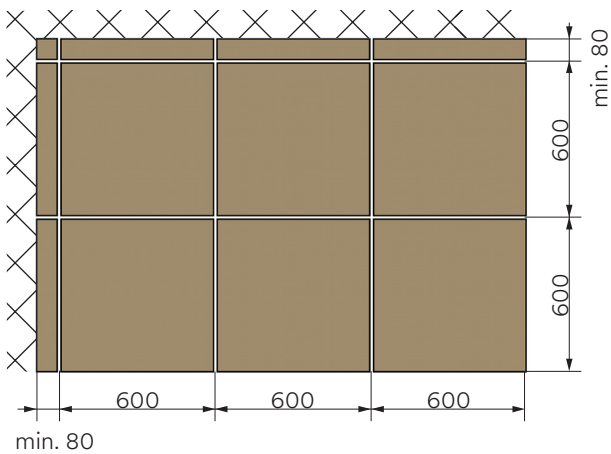
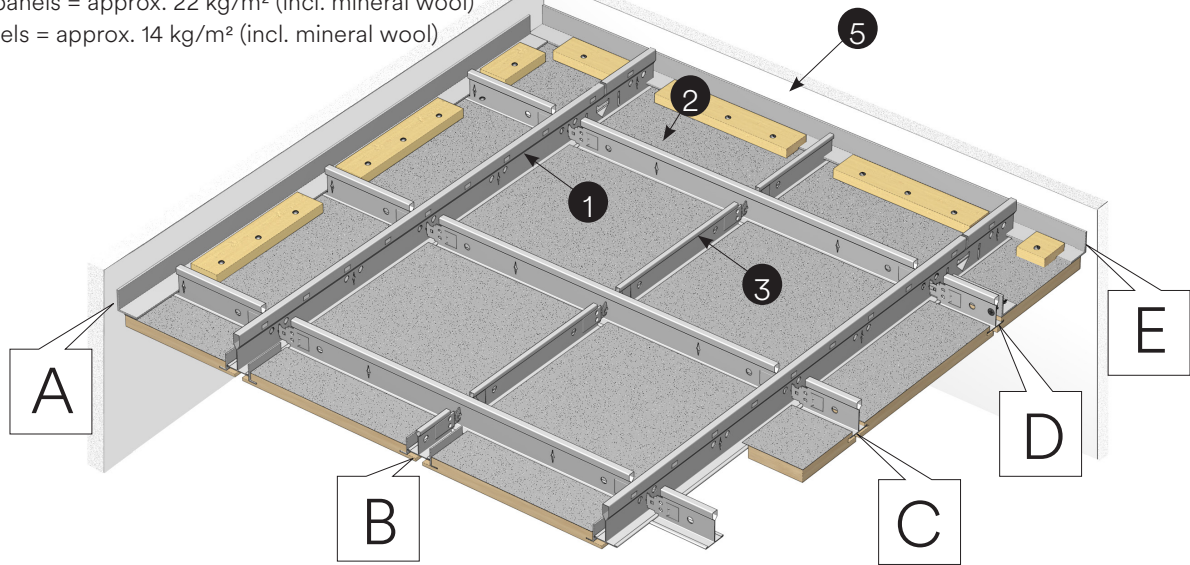

- Sign: Space (mm)
- A 1200 Standard
 - B 1200
 - C max. 400
 - D 600

Materials required for the Donn DX24 subconstruction (per m² ceiling area). All specifications are approximate values without cuttings.

No.	Description	Item designation	Module 600 x 1200
①	Bearing rail	DX24 XH 370	0,83 m
②	Cross-rail, long	DX24 XM 120	1,67 m
③	Cross-rail, short	DX24 XS 60	0,83 m
④	Suspending bracket		0,70 piece
⑤	Wall bracket		depends on room dimensions (approx. 0.4 running meters/m ²)

Details refer to the previous pages

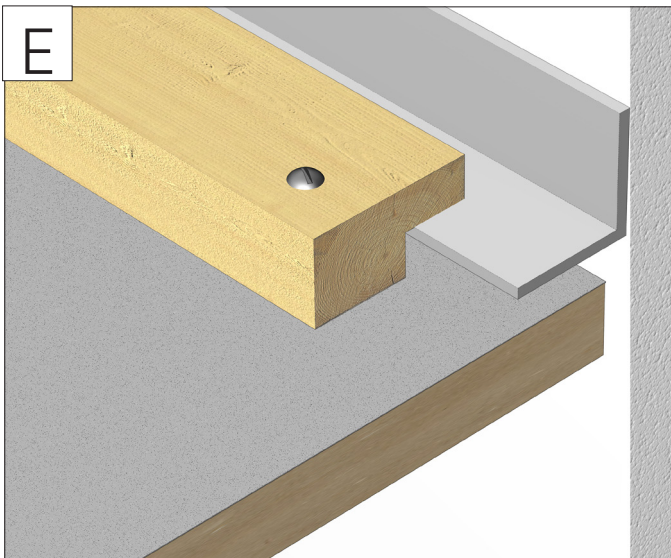
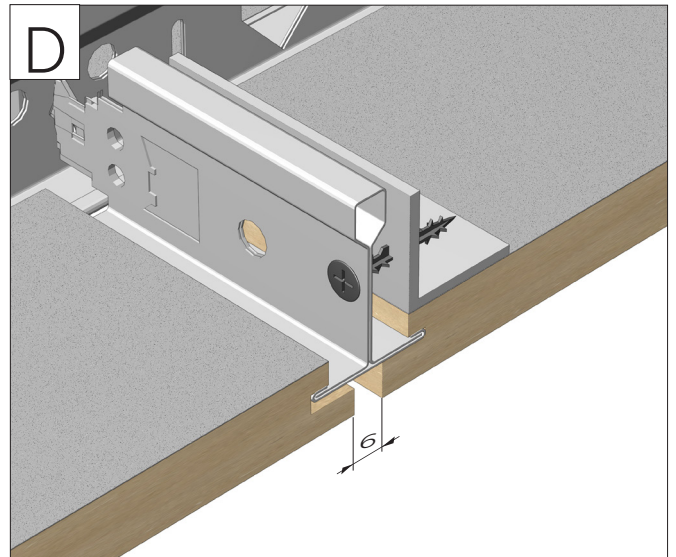
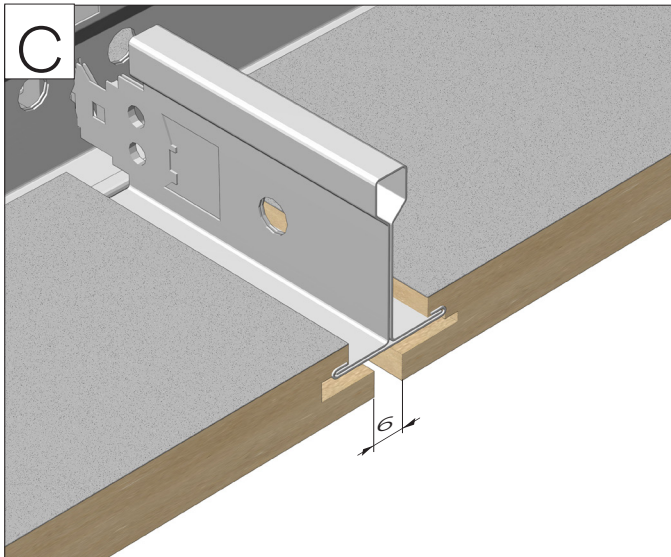
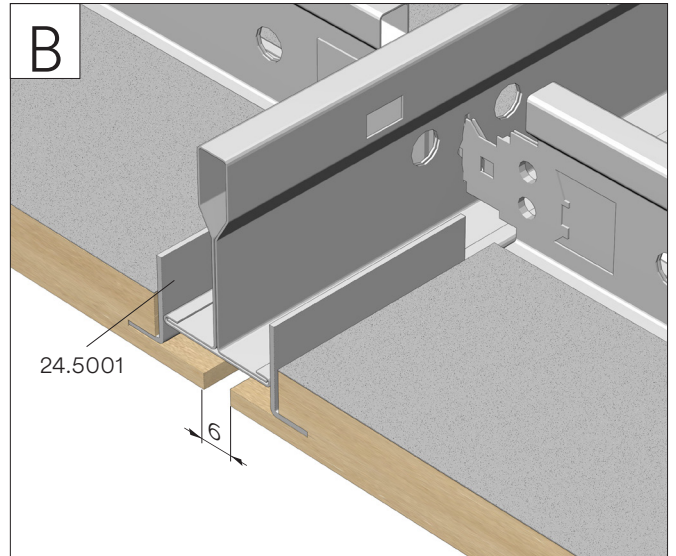
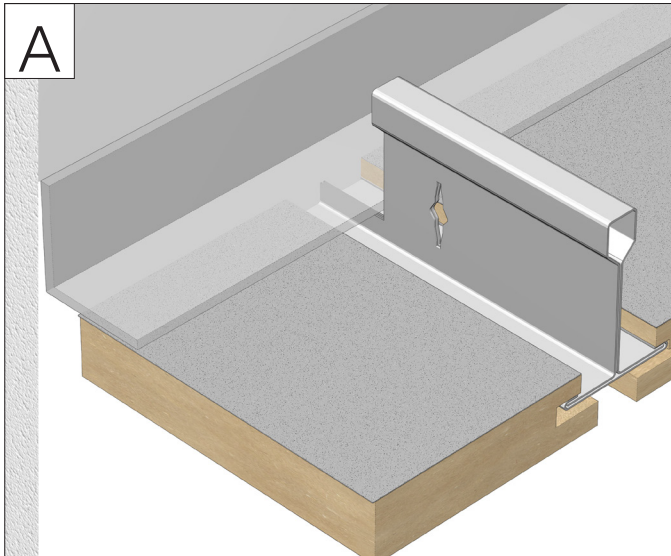

Type D

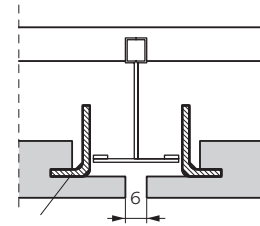
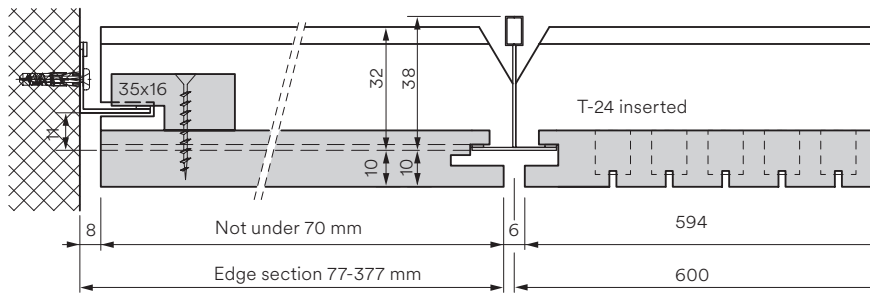

24.5001
Reinforcement for the transverse edges Size: 559x19/11 mm

Type B24

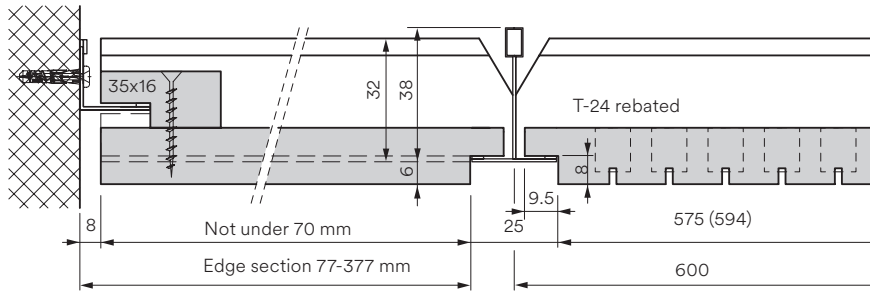

Type D, alternative detail

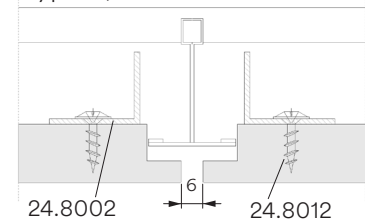

24.8002 24.8012
Universal angle, L = 2496 mm

Type B15

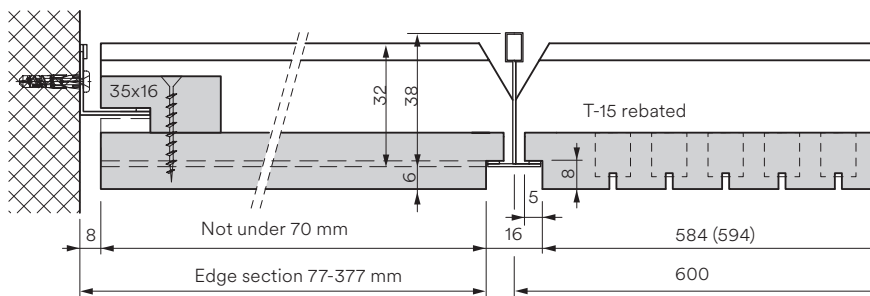

Type C15

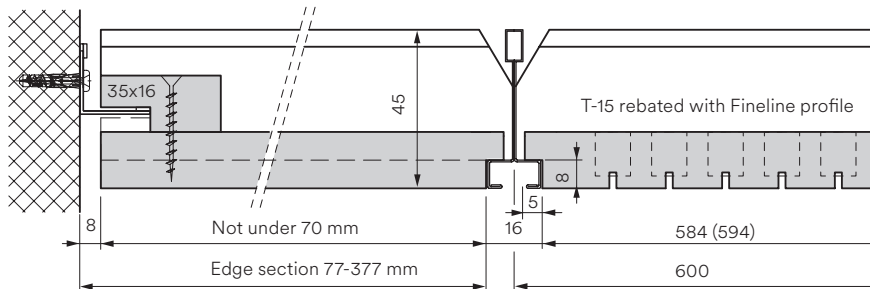

Type A24

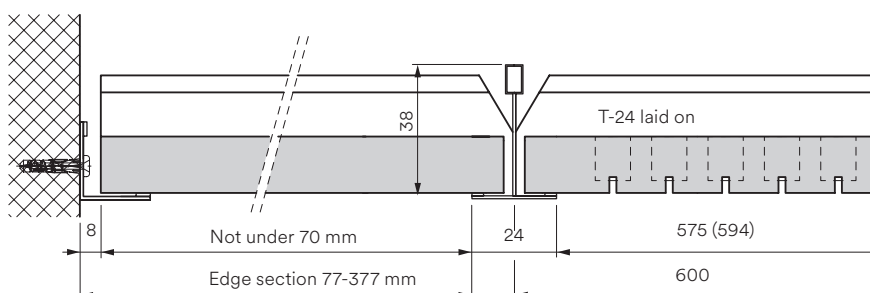

Type A15

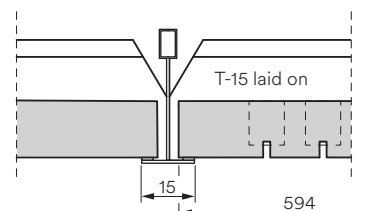

SL1 System - Ceiling - Installation with slatted grid

The perforation must be set back at the factory, if the panels will be scribed to the wall on site.

Blind holes are always along the long panel edge (in cross-direction to the grid), max. distance between blind hole rows 500 mm, these are divided in the factory.

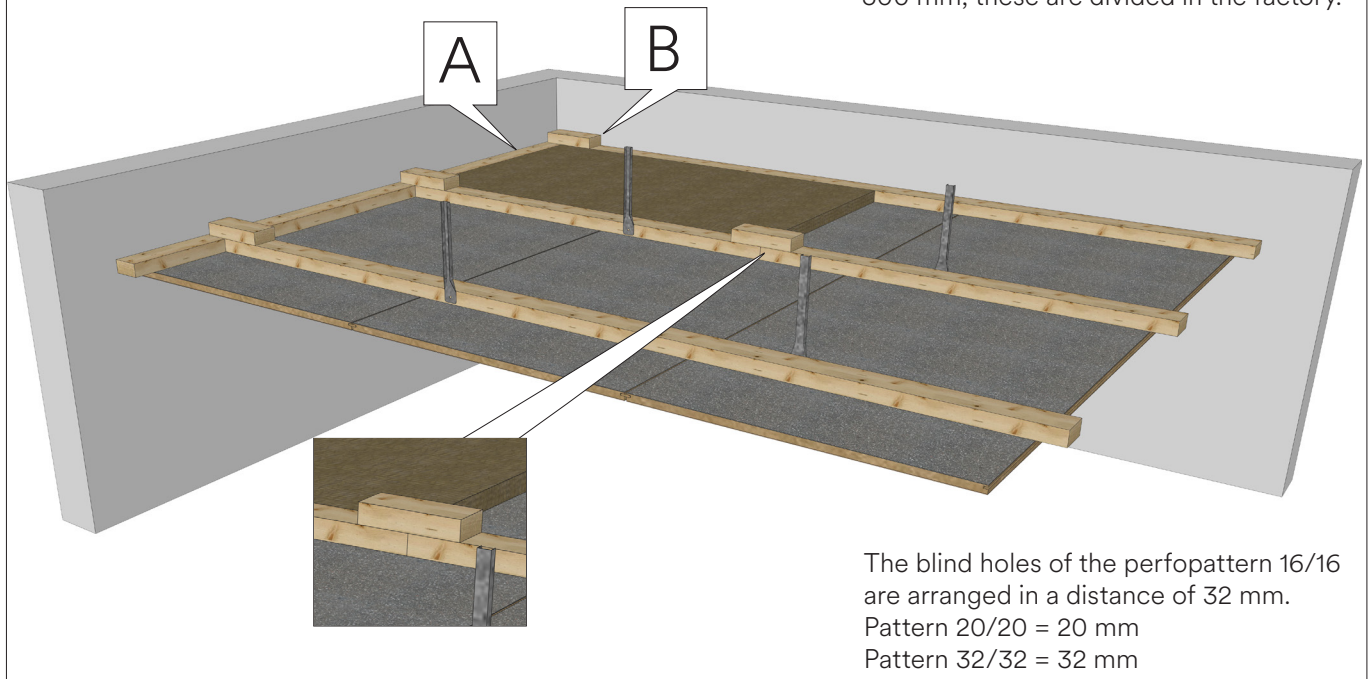

Wood-Installation on transversal grid (wood moisture max. 10%)

Sub-construction: Topakustik panels (without increased fire protection requirement) are fastened to a perfectly installed transverse lathing of planed, dry spruce boards 60/30 mm.

When installing the slats by means of a Nonius hanger (hangers are offset left and right with the grid).

Hanger spacing 800 mm, arrange Topakustik element impacts on the transverse plate.

Consider fading/swelling behaviour (check «important notes» page 4 + 5)

Wall connection

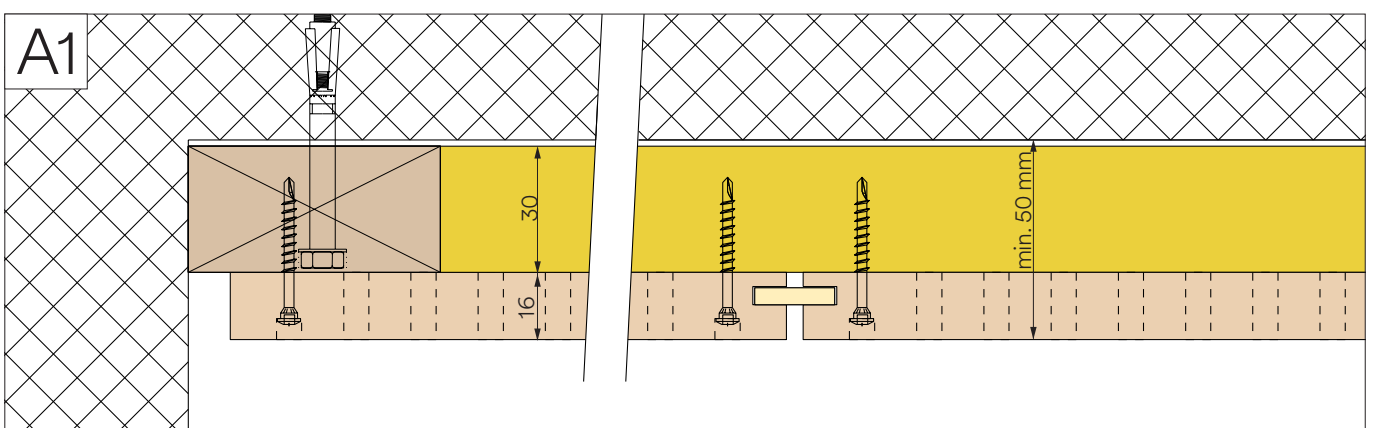
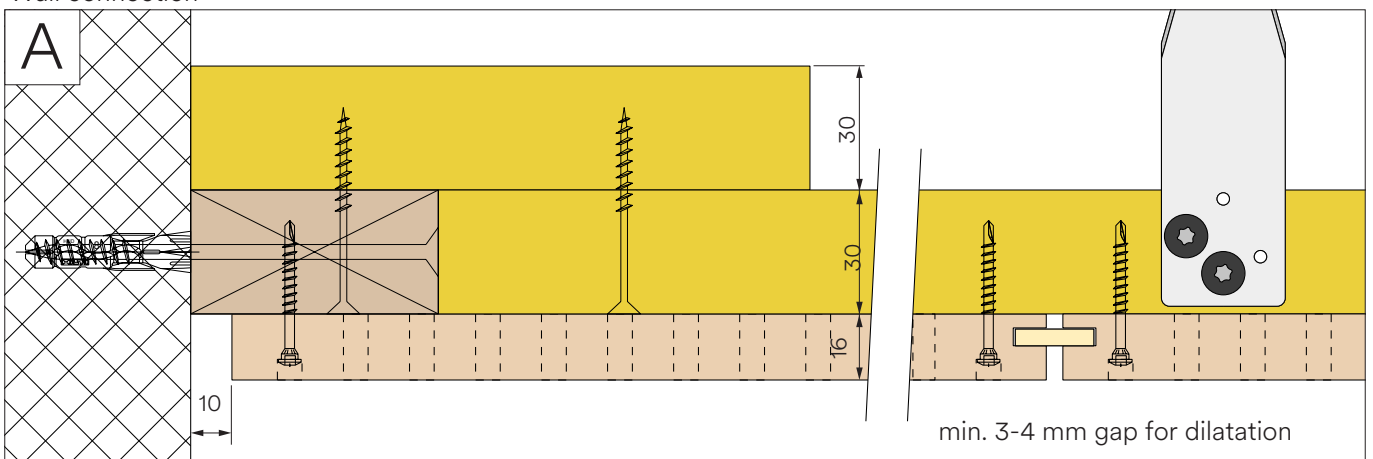

Wall connection

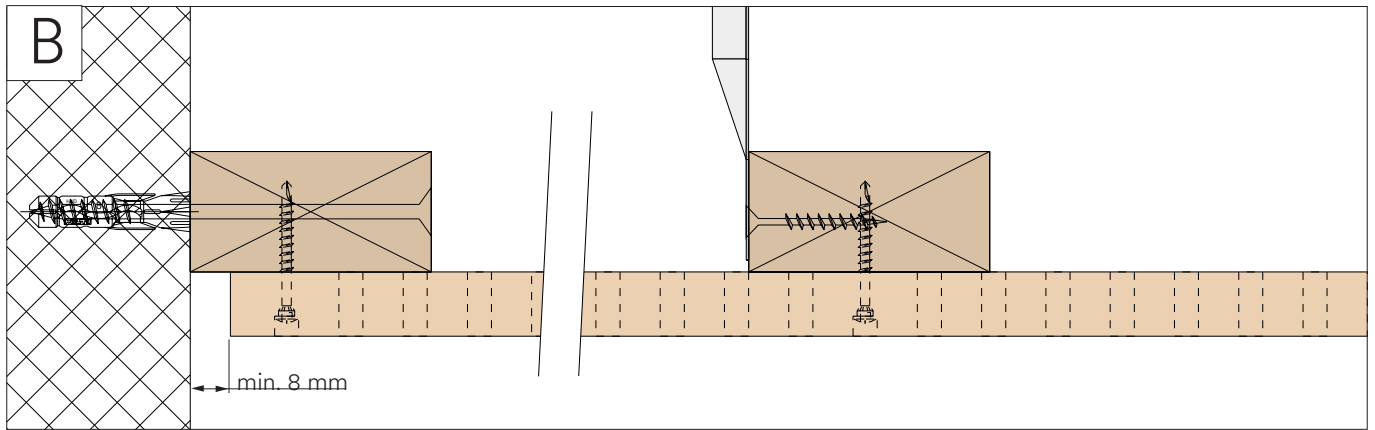

Substructure versions Ceiling:

Metal-wood counter-grid with Nonius hangers

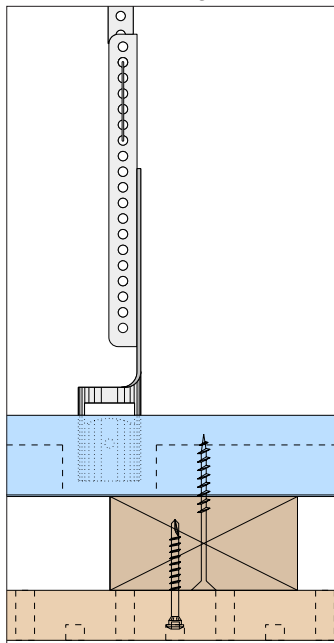

Metal counter-grid with Nonius hangers

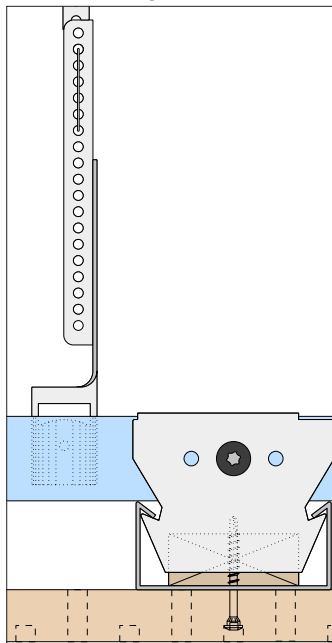

Metal-wood counter-grid with direct suspension

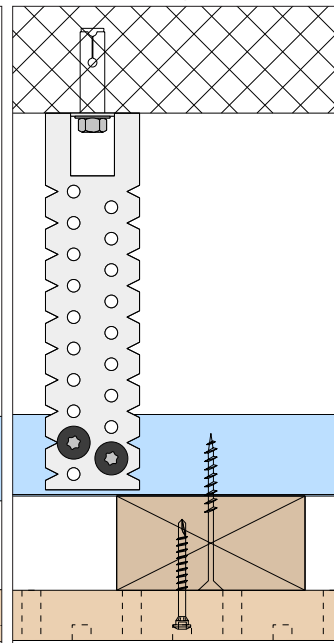

Wooden counter-grid with Nonius hangers

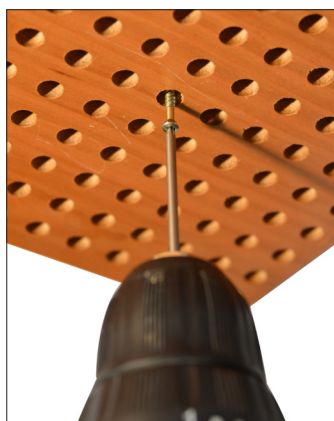
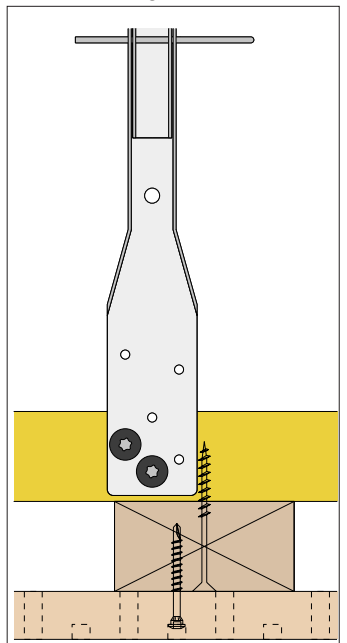

For assembly, press the panels well to the substructure, screw in with the bit attached.



Please note:

- Set the torque correctly
- Do not jigging the screw
- If needed make a slug test
- Tighten the head slightly, do not scuttle into the plate

Overview Topakustik-System screws

Article: 24.1045 = hole \varnothing 4-5 mm Packing size 200 pcs. without shank, with drillbit

Article: 24.1056 = hole \varnothing 5-6 mm Packing size 200 pcs. with shortshank 3mm and drillbit

Article: 24.1060 = hole \varnothing 6 mm Packing size 500 pcs. with shank 10 mm and drillbit

Screw requirement (fist rule) = 15 pcs/m²

SL2 System - Wall - Installation with slatted grid

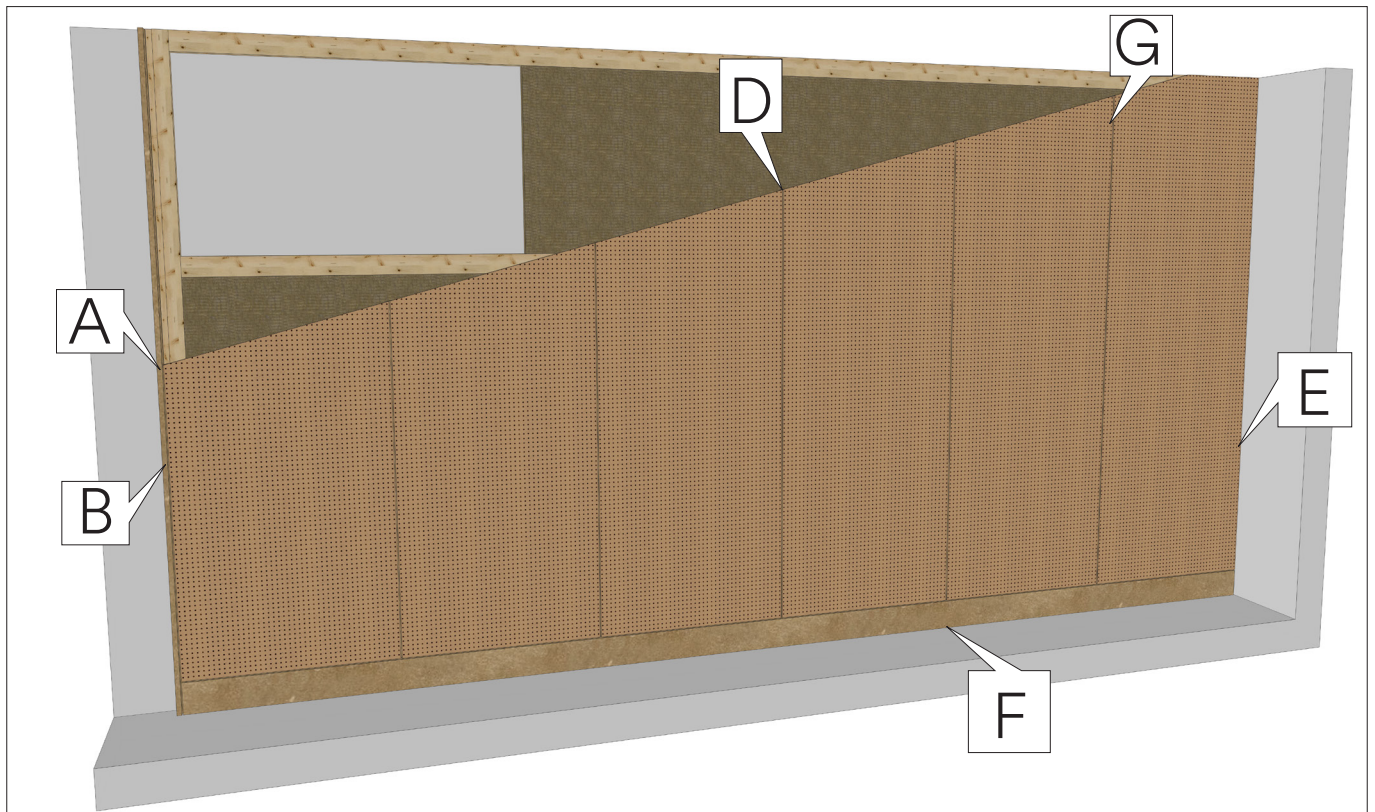

Finishing detail with edge molding type 1

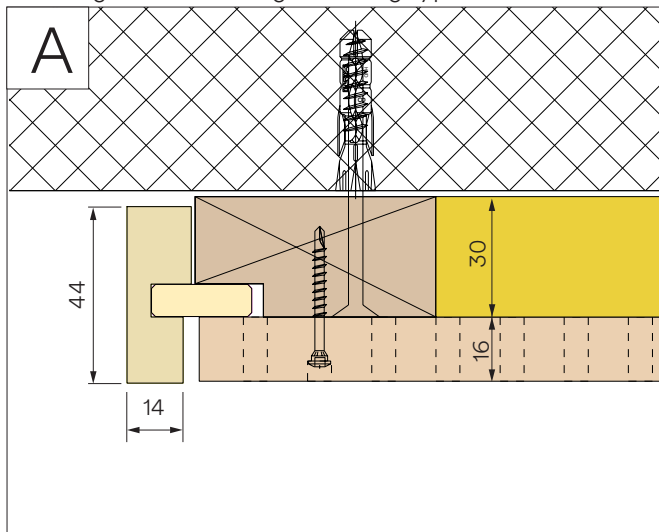

Finishing detail with wall corner type 26

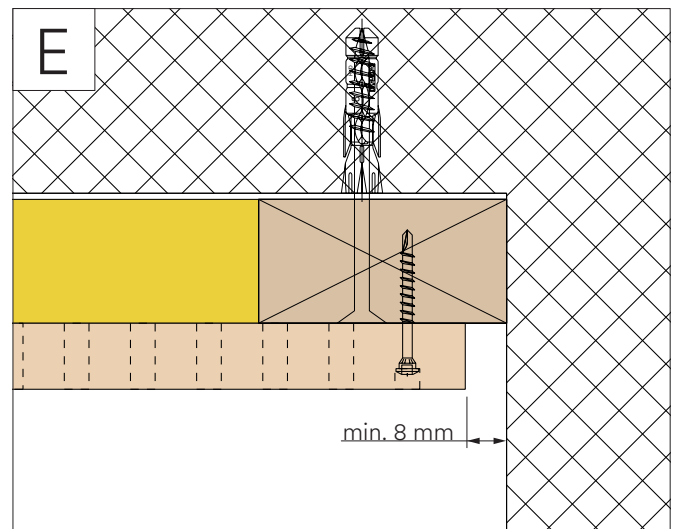
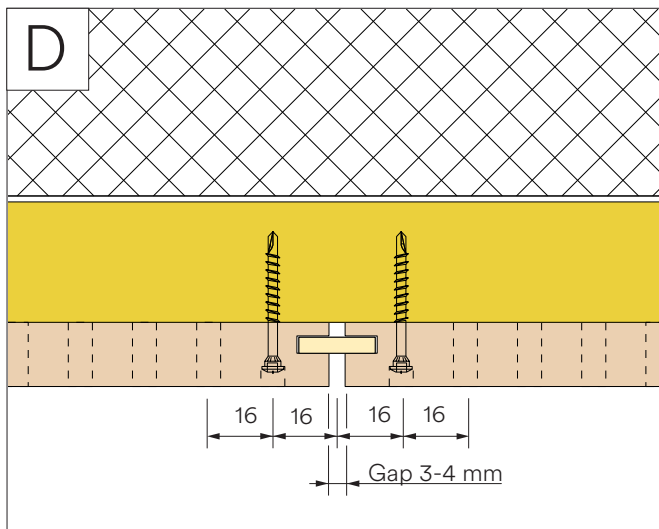
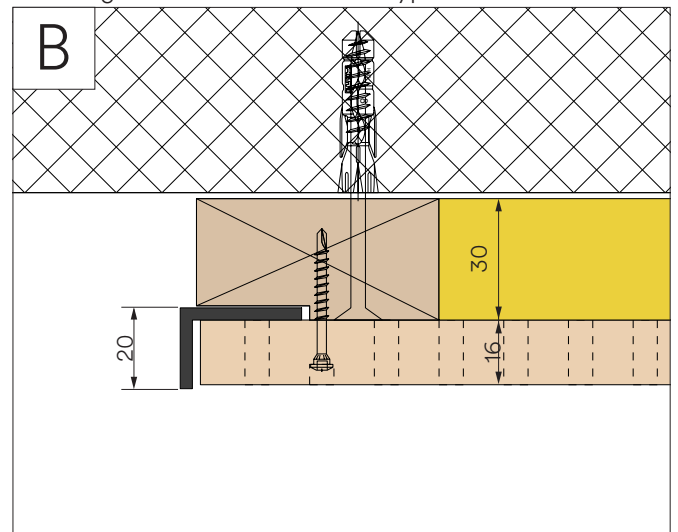

SL2 System - Wall - Installation with slatted grid

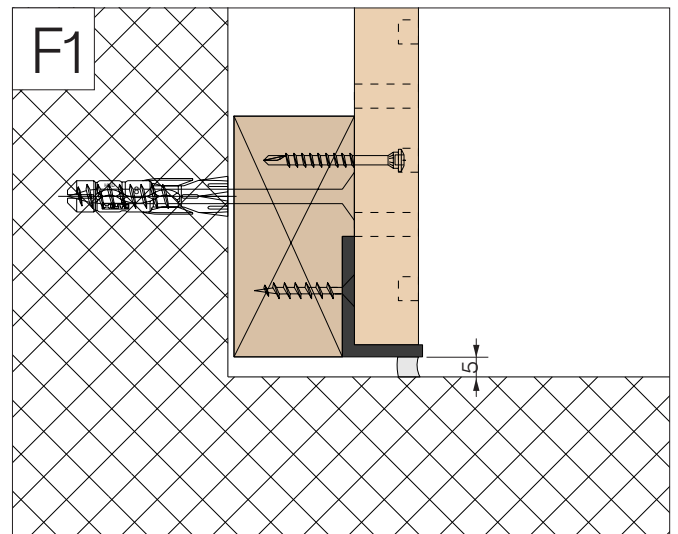
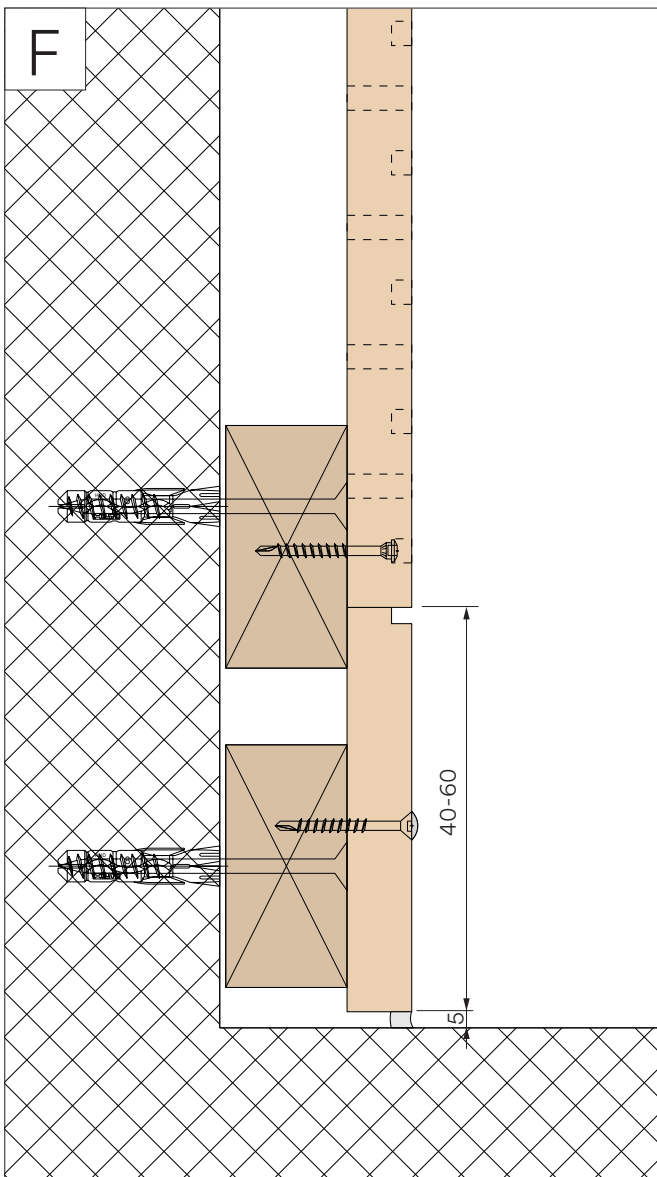
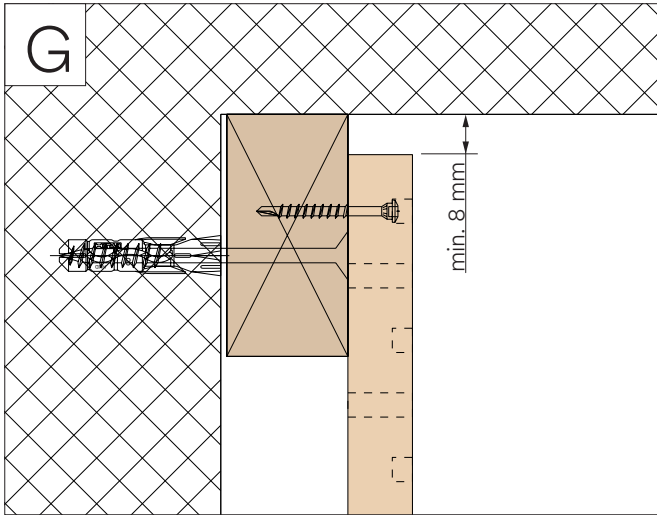

SL3 System installation option with expansion dowel inserted on visible side.

This option is for asymmetric panel shapes, graphic and bubble perforations, but can also be used for M-holes. Available for hole sizes Ø 8, 10 and 12 mm. Since the sleeves and screws are black, the installation is practically invisible, offering an advantage over blind holes (SL1 and SL2).

Tech. data of sleeves				Tech. data of screws			
Art. no.	Designation	Length	PU	Art. no.	Size	Recess	PU
24.1280	Ø 8 mm	10 mm	100	24.1208.1	3.5 x 35	TORX 20	100
24.1210	Ø 10 mm	10 mm	100	24.1210.1	4.5 x 35	TORX 20	100
24.1212	Ø 12 mm	10 mm	100	24.1212.1	5 x 35	TORX 20	100



expansion dowel



During installation, the expansion dowel is inserted from the visible side. The sleeve must be pushed down to the acoustic material. Insert wood screw and tighten.

Cross section of perforated hole with inserted sleeve

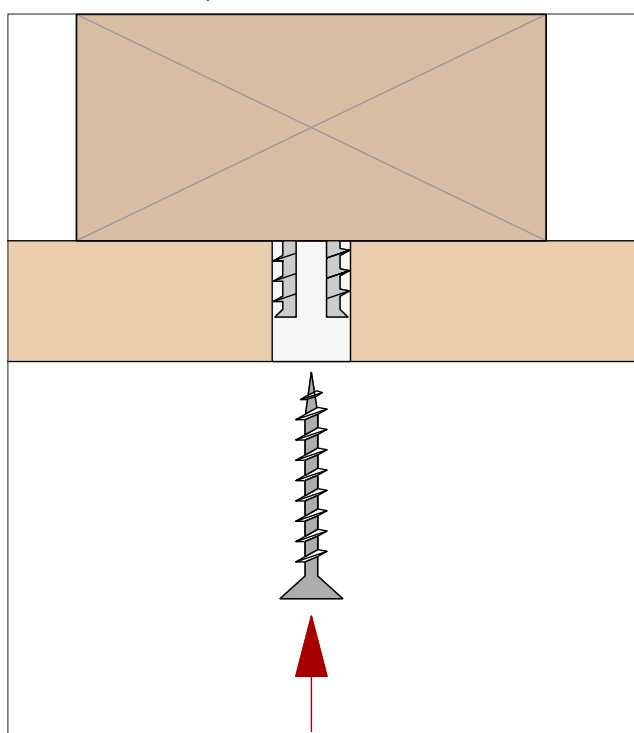



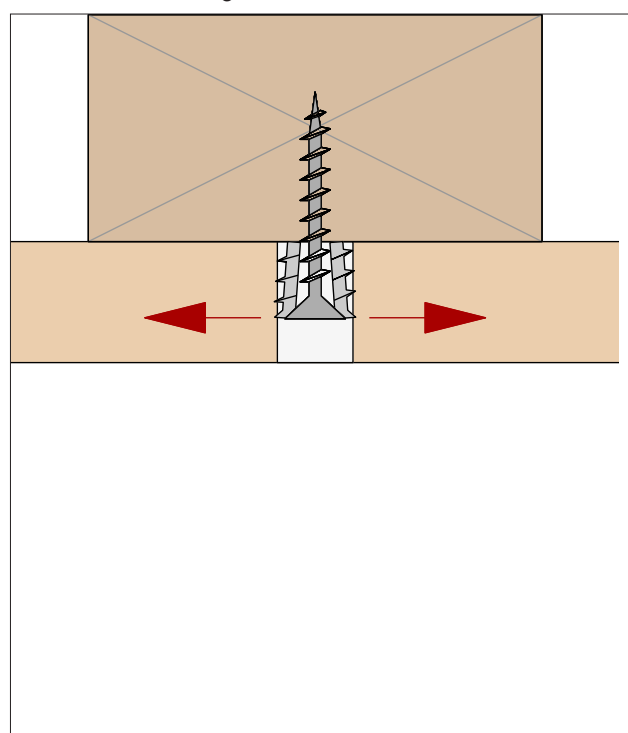



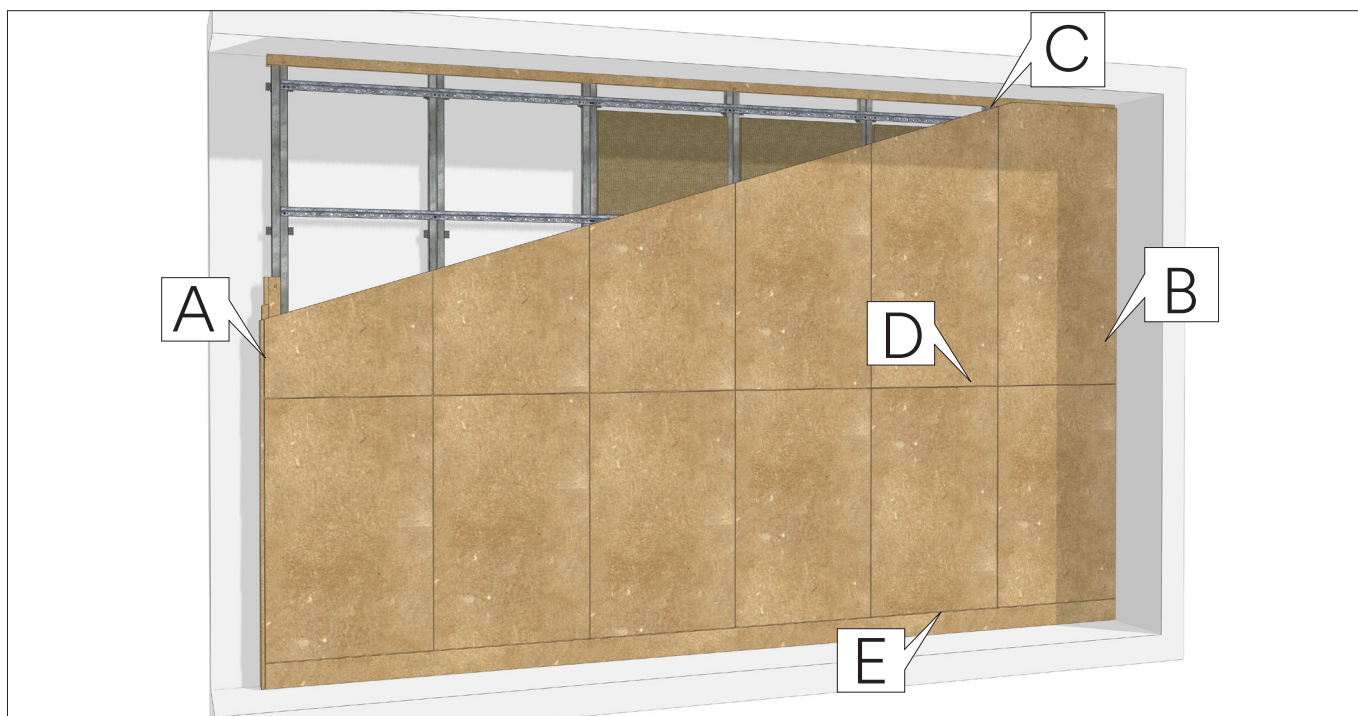





Cross section of tightened screw with widened sleeve



EpM 1 System mounting profile for wall installation



Picture	Label	Art. no.	Length	EpM 1	EpM 2	EpM 3
	Cleat with rebated joint 4000 x 60 x 32 mm, MDF D-s2, d0	24.4011	4000 mm			✓
	Cleat with rebated joint 4000 x 60 x 32 mm, MDF B-s2, d0	24.4012	4000 mm			✓
	Cleat with rebated joint 3000 x 60 x 32 mm, RESAP® EN A1	24.4013	3000 mm			✓
	Cleat with rebated joint 4000 x 60 x 16 mm, MDF D-s2, d0	24.4014	4000 mm		✓	
	Cleat with rebated joint 4000 x 60 x 16 mm, MDF B-s2, d0	24.4015	4000 mm		✓	
	Cleat with rebated joint 3000 x 60 x 16 mm, RESAP® EN A1	24.4016	3000 mm		✓	
	EpM-base profile steel	24.4017	2500 mm	✓		
	EpM-hook-in-profile steel	24.4010	2500 mm	✓	✓	✓
	Fixing screw 4 x 15 mm support bracket	24.8012	15 mm	✓	✓	✓
	Support bracket	24.4018	2500 mm	✓		
	Grid template for Epm-base profile	24.4025	2483 mm	✓		
	Grid template for Epm-hook-in-profile, panel	24.4026	2491 mm	✓		
	Grid template connector set, for Epm- hook-in-profile, panel	24.4027	1248 mm	✓		

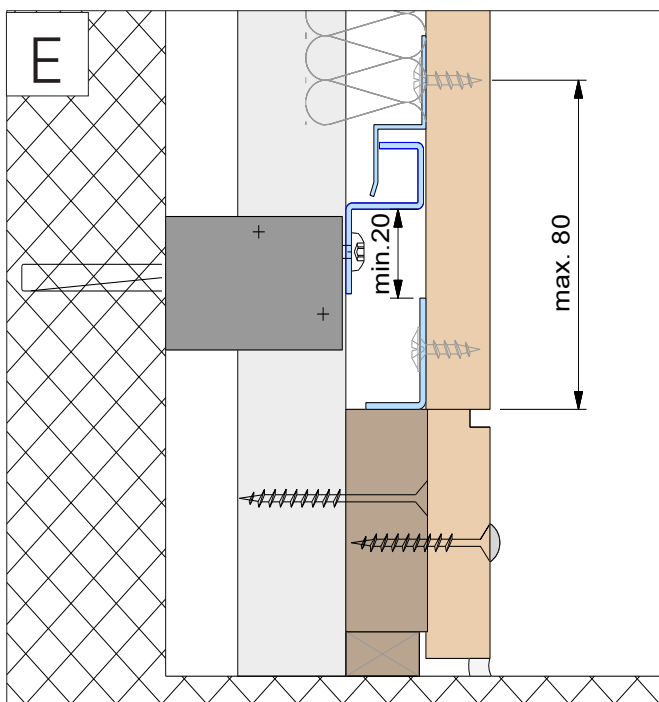
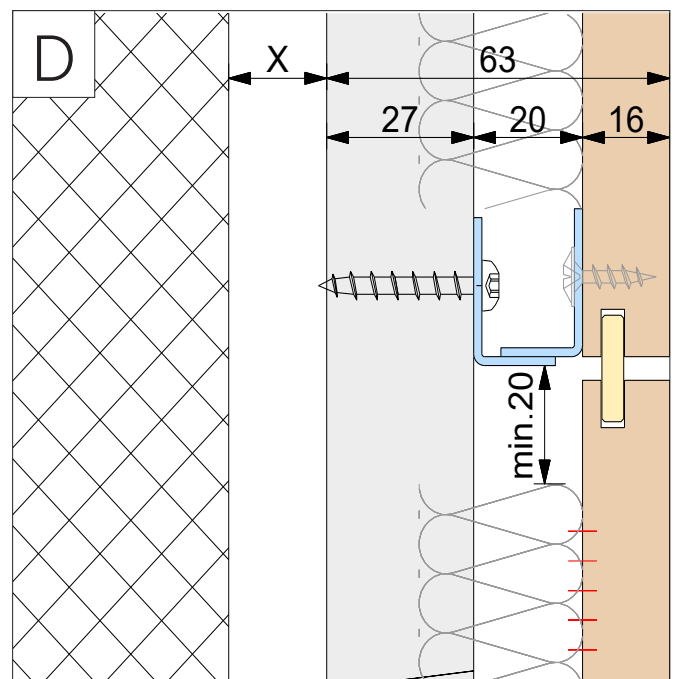
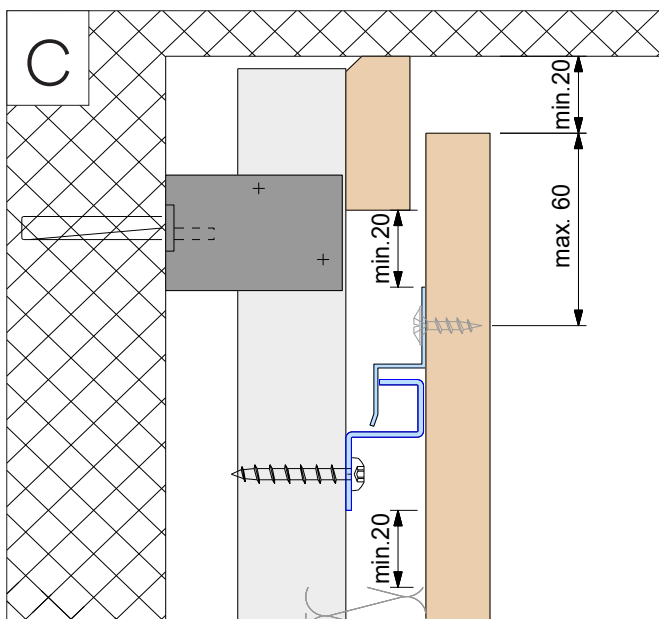
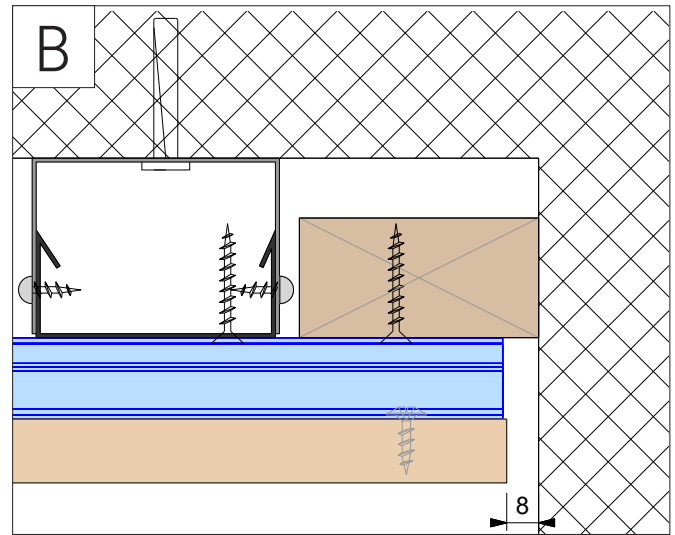
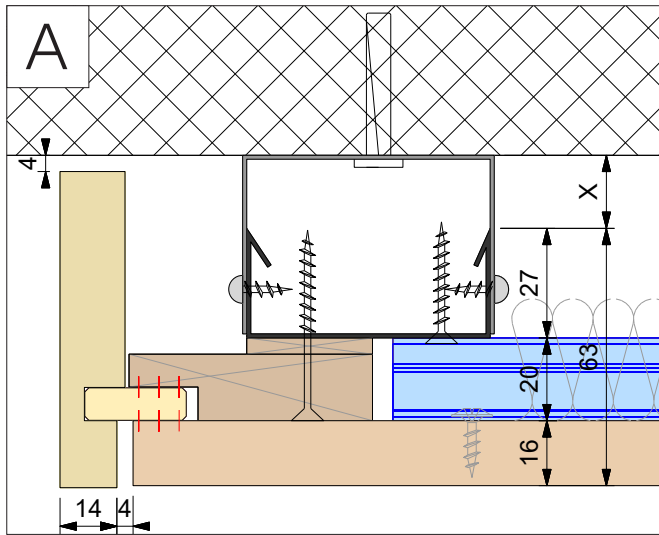

Substructure and panel fixation: The basic vertical grid is installed using CD profiles 60x27 mm, verified spacers and suitable fixing materials for the substrate at a max. distance of 600 mm.

The basic grid must be placed on the floor in order to dissipate the weight of the panels on the substrate. Alternatively, the substructure can be installed with wood slats in the dimensions 60 x 30 mm (observe fire resistance specifications). The upper edge of the baseboard must be cleanly installed in the horizontal and is considered a reference point for the assembly of the EpM substructure.

The baseboard should also be supported to dissipate the weight downwards. The EpM panel profiles are installed with a fixing screw 4 x 15 mm into the non-perforated areas of the acoustic panel on the reverse side. The profiles are installed using the grid jigs according to the description on the next page.

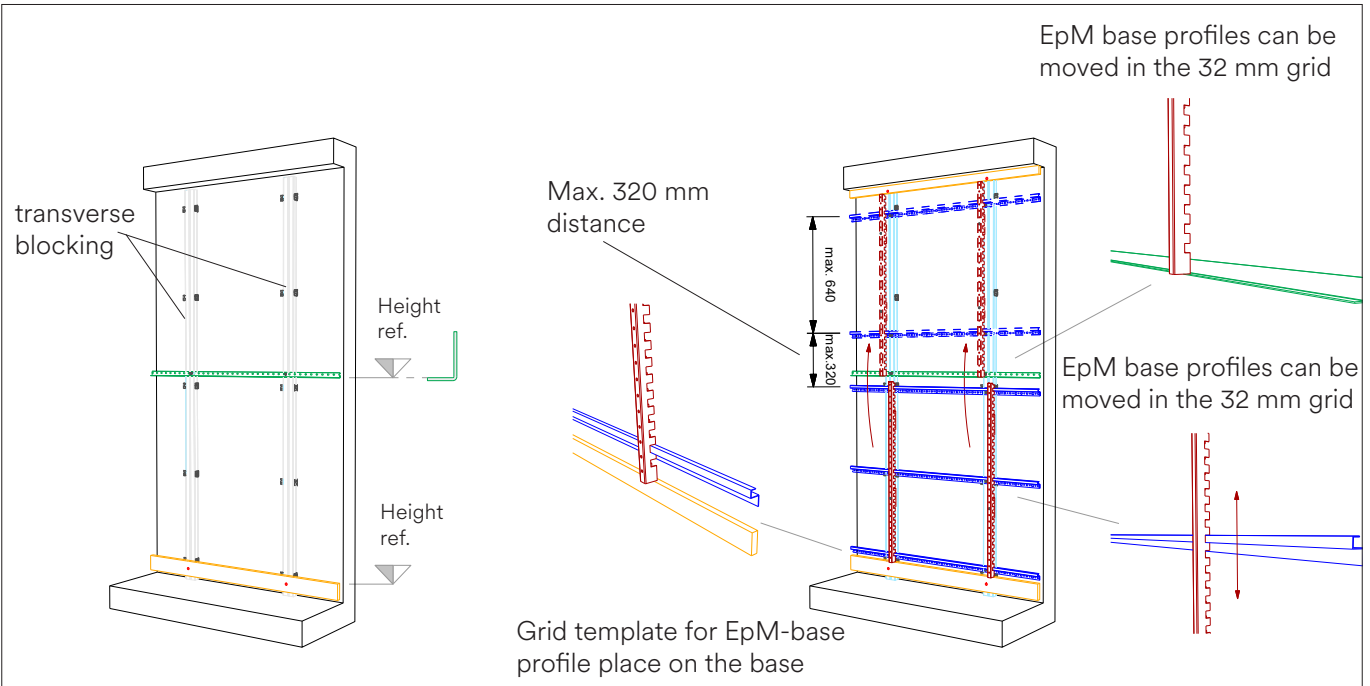

Step 1: Screw the base and support bracket to the corresponding height with the counter-laths.

Step 2: EpM-base profile mount with grid template

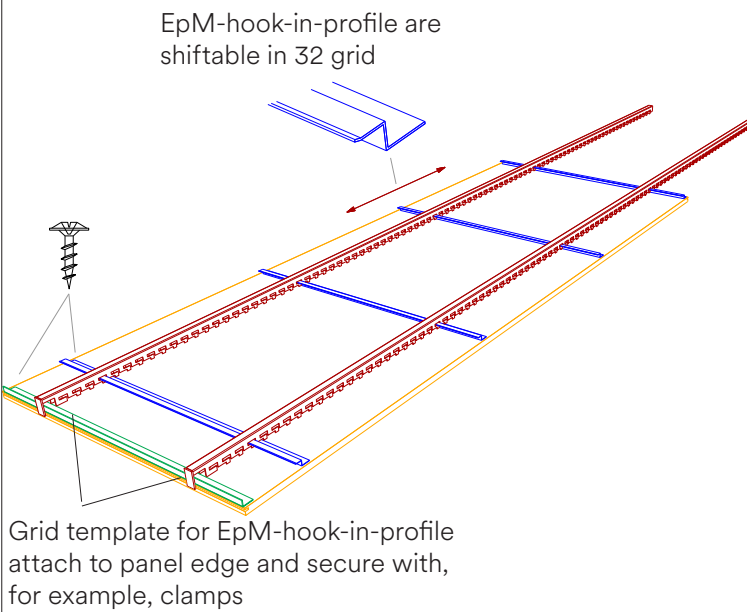

Step 3: Support bracket and EpM-hook-in-profile Mount onto the panels with help of the grid jig

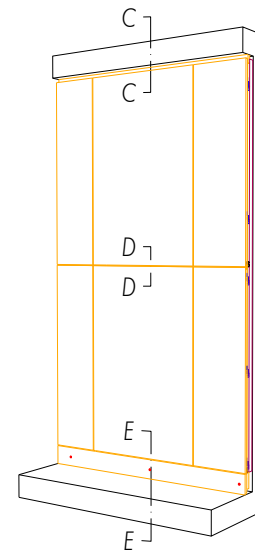

Step 4: Mount panels

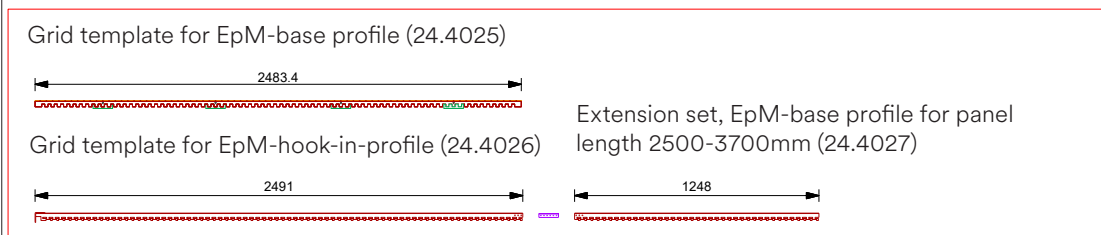

EpM 2 System mounting profile for wall installation

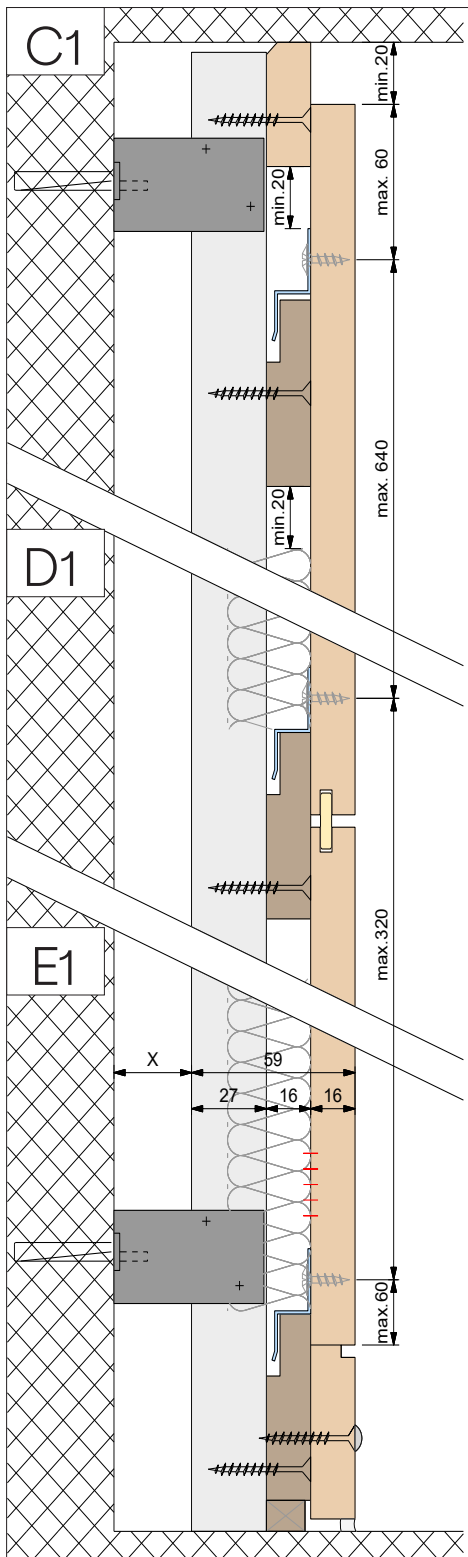
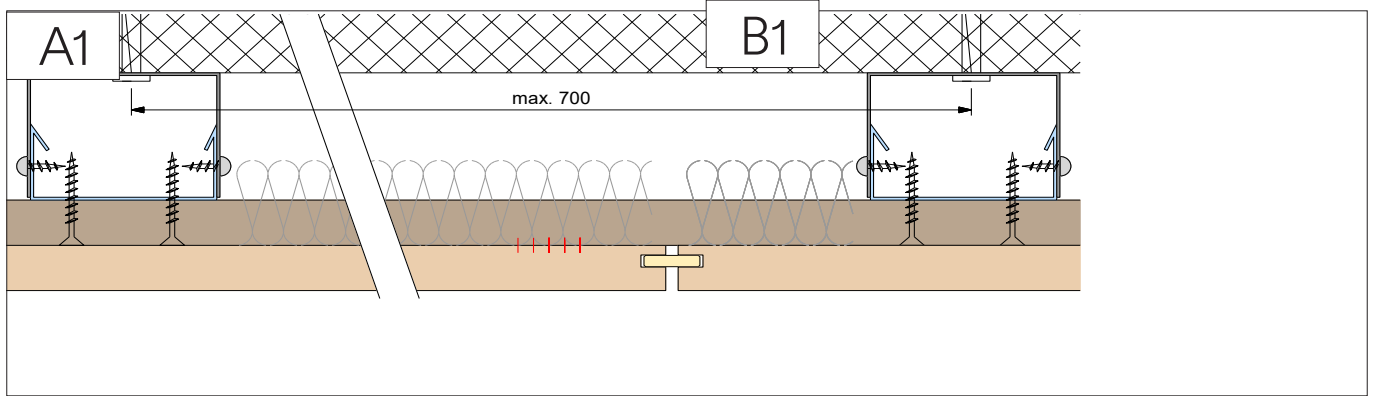

Substructure and panel fixation: The basic vertical grid is installed using CD profiles 60x27 mm, verified spacers and suitable fixing materials for the substrate at a max. distance of 600 mm.

The basic grid must be placed on the floor in order to dissipate the weight of the panels on the substrate. Alternatively, the substructure can be installed with wood slats in the dimensions 60 x 30 mm (observe fire resistance specifications). The upper edge of the baseboard must be cleanly installed in the horizontal and is considered a reference point for the assembly of the EpM substructure.

The baseboard should also be supported to dissipate the weight downwards. The EpM panel profiles are installed with a wood screw 4 x 15 mm into the non-perforated areas of the acoustic panel on the reverse side. The profiles are installed using the grid jigs according to the description on the next page.

In the case of grooved or M+T perforated acoustic products, the EpM panel profiles can be alternatively attached to the perforation on the reverse side using system screws \varnothing 8/9/10 mm. Max. distance between the assembly profiles is 640 mm.

The mineral wool is pressed between the substructure with a protrusion of 16 mm, according to the following diagrams.

EpM 3 System mounting profile for wall installation

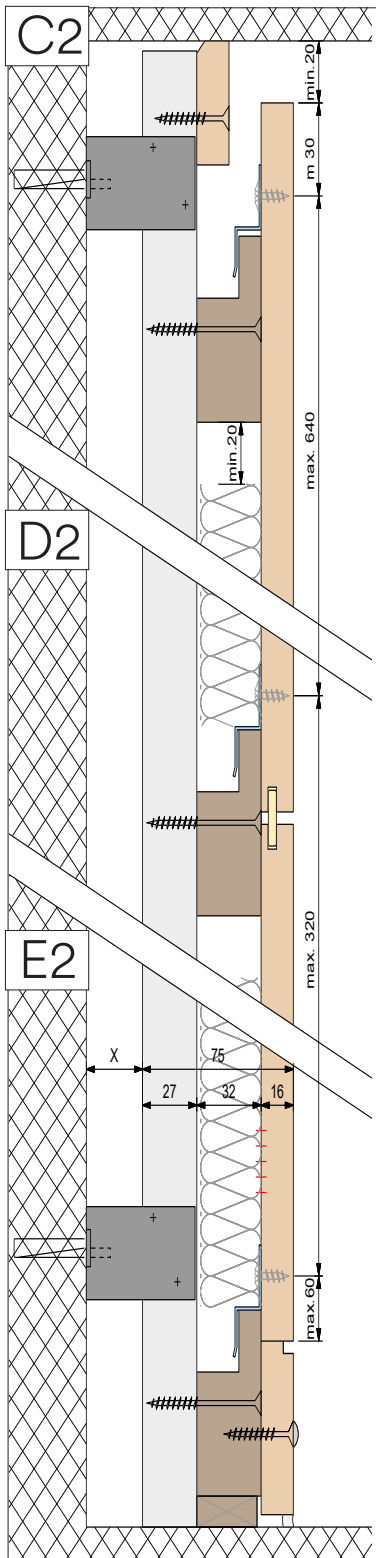
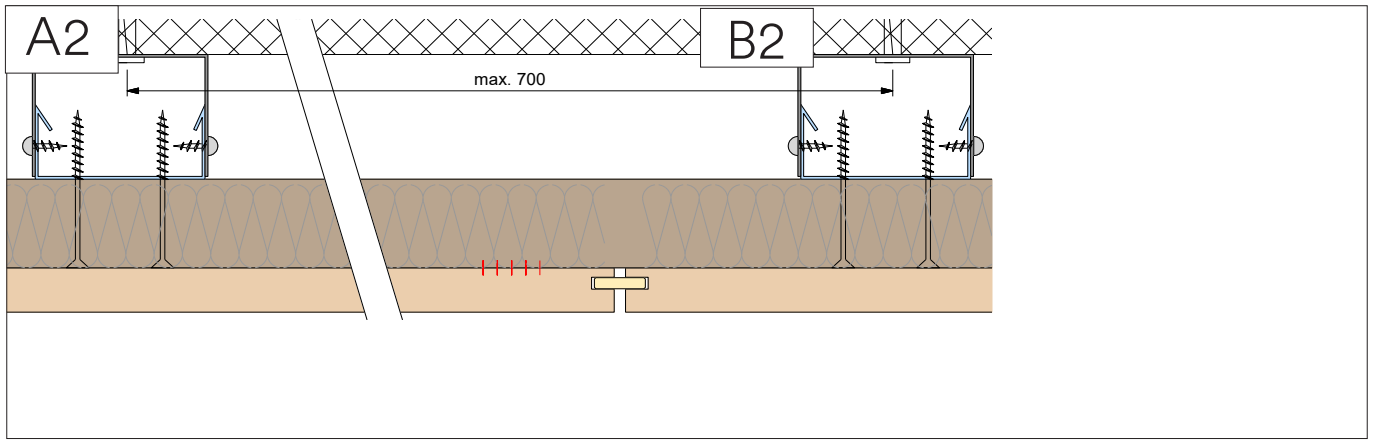

Substructure and panel fixation: The basic vertical grid is installed using CD profiles 60x27 mm, verified spacers and suitable fixing materials for the substrate at a max. distance of 600 mm.

The basic grid must be placed on the floor in order to dissipate the weight of the panels on the substrate.

Alternatively, the substructure can be installed with wood slats in the dimensions 60 x 30 mm (observe fire resistance specifications). The upper edge of the baseboard must be cleanly installed in the horizontal and is considered a reference point for the assembly of the EpM substructure.

The baseboard should also be supported to dissipate the weight downwards. The EpM panel profiles are installed with a wood screw 4 x 15 mm into the non-perforated areas of the acoustic panel on the reverse side. The profiles are installed using the grid jigs according to the description on the next page.

In the case of grooved or M+T perforated acoustic products, the EpM panel profiles can be alternatively attached to the perforation on the reverse side using system screws \varnothing 8/9/10 mm. Max. distance between the assembly profiles is 640 mm.

The mineral wool should be adhered pointwise to the acoustic panels at the rear, according to the adjacent diagrams.

FL1 System for ceiling (wood rabbet strip)

Installation on slats (wood moisture max. 10%) substructure: Topakustik panels (without increased fire protection requirement) are fitted on perfectly installed slats made from planed, dry spruce wood slats 60/30 mm.

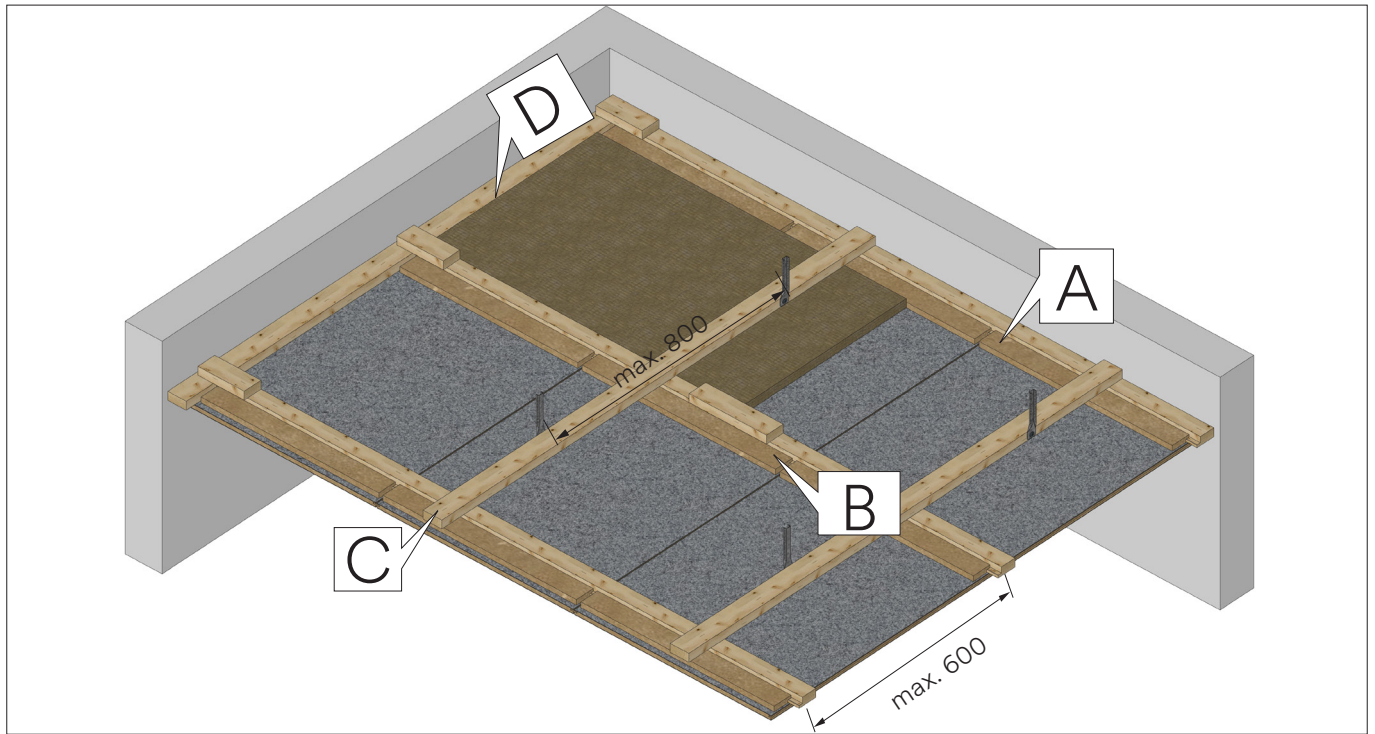

When installing the slats using Nonius hangers (staggered hanger arrangement, left and right of the slat), hanger distance max. 800 mm. Glue rabbeted joint (secure against falling, also possible with screws). Glue cover panel to substructure slat (test adhesion so that the adhesive optimally bonds the material on the panel and slat!) Installation of the rabbet strips on the substructure and panels using conventional wood screws.

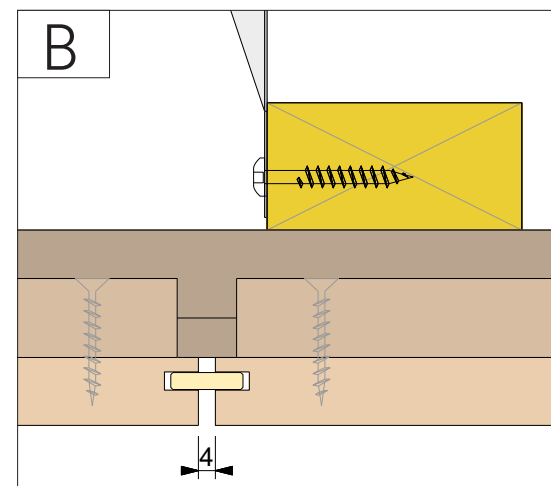
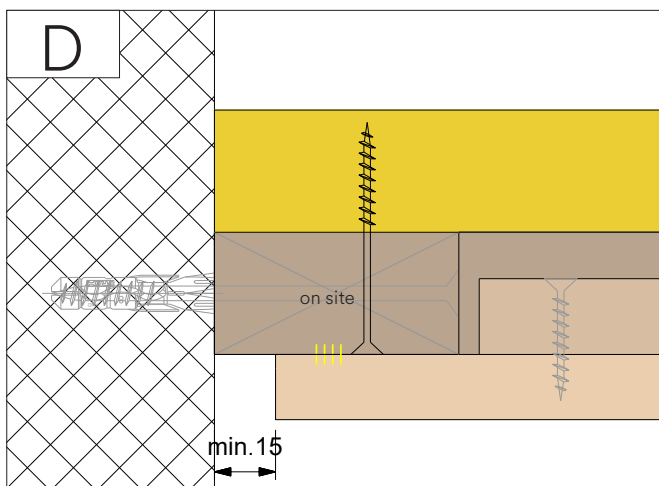
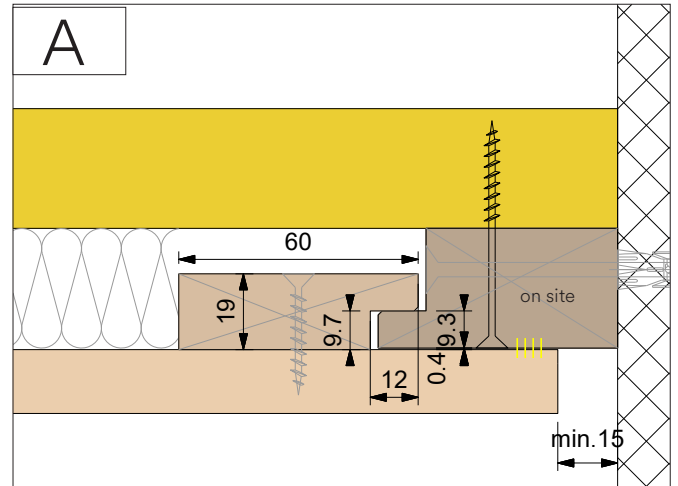
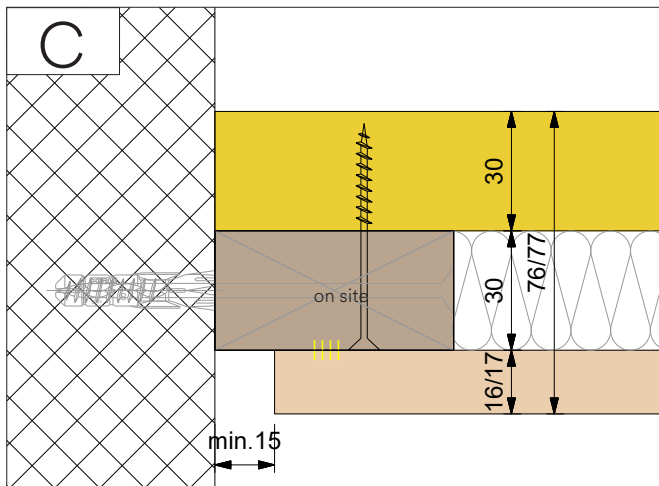

Please note shrinkage and swelling behaviour (see "Important information" on page 4+5)

FL2 System for wall (wood rabbet strip)

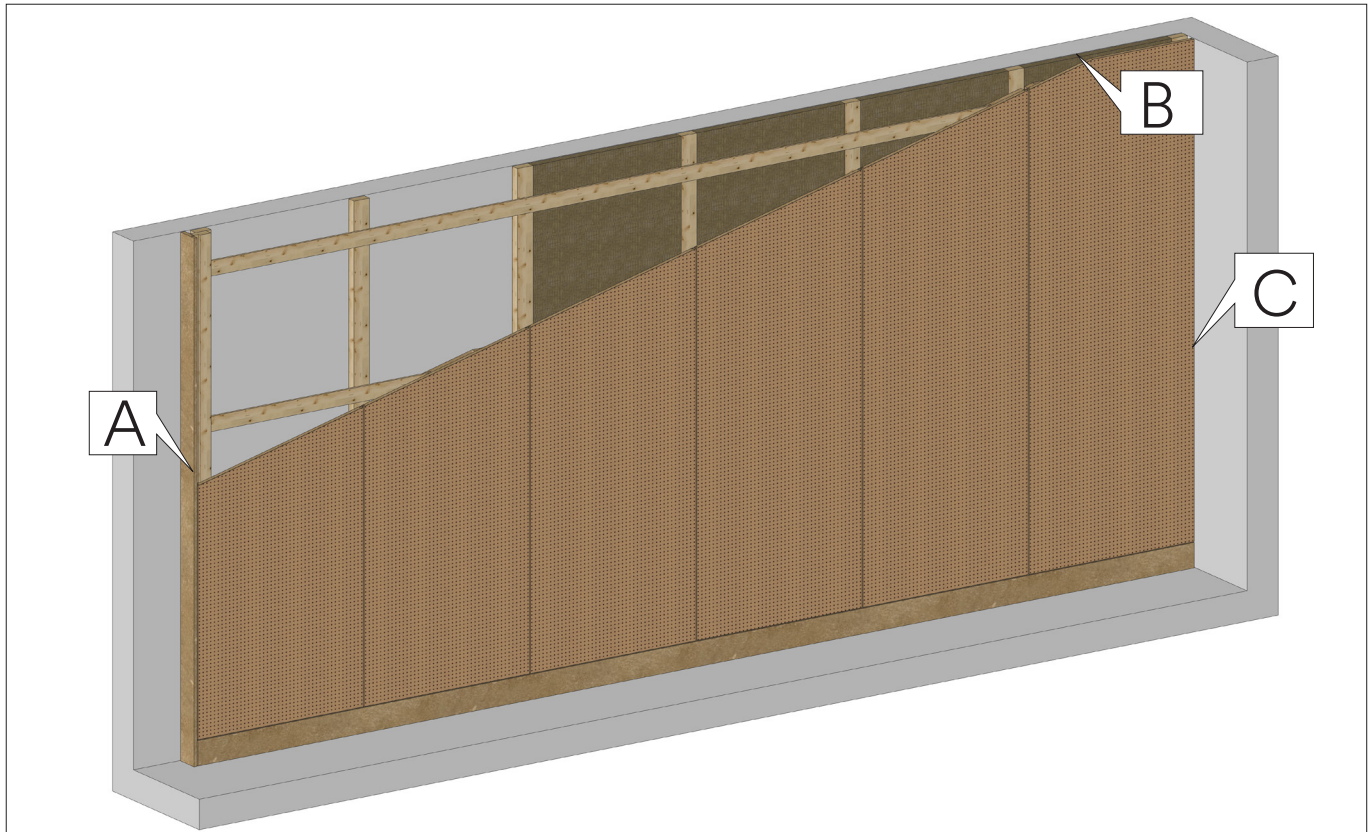

Substructure and panel fixation: Installation on wood slats (wood moisture max. 10%). Topakustik panels (without increased fire protection requirement) are fitted on perfectly installed slats made from planed, dry spruce wood slats 60/30 mm. Slats are placed on the floor to dissipate weight load.

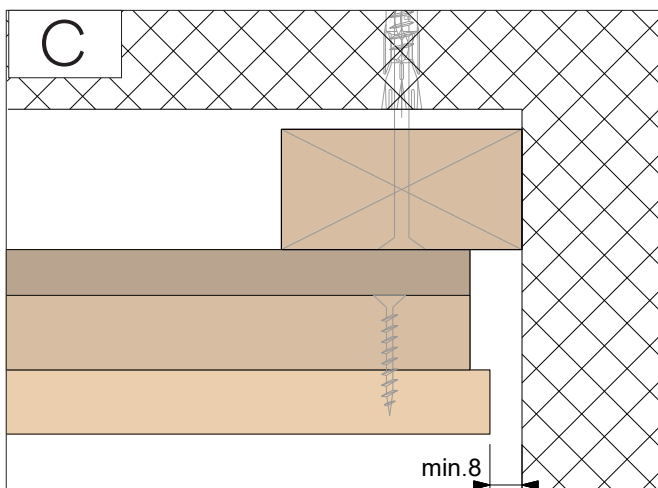
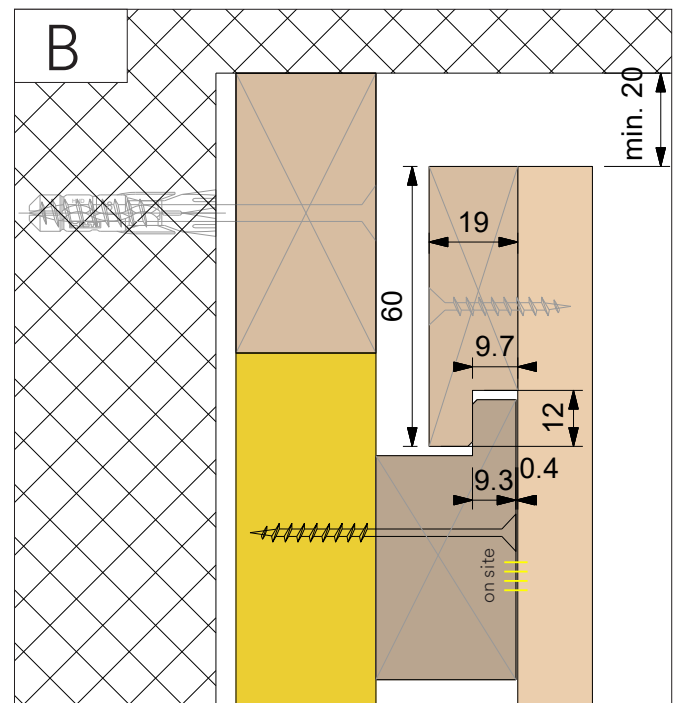
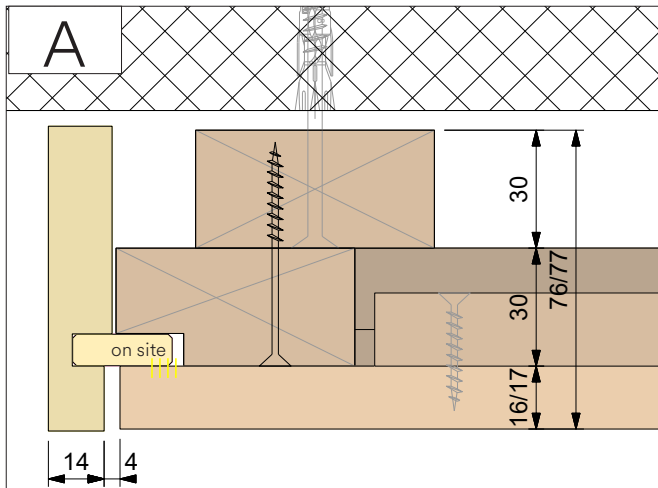

Use spacers or spacer bolts to fix to bare wall when installing slats (observe manufacturer's information from the supplier of the fixing material). Installation of the rabbet strips on the substructure and panels using conventional wood screws.

Please note shrinkage and swelling behaviour (see "Important information" on page 4+5)

Hat profile for wall installation

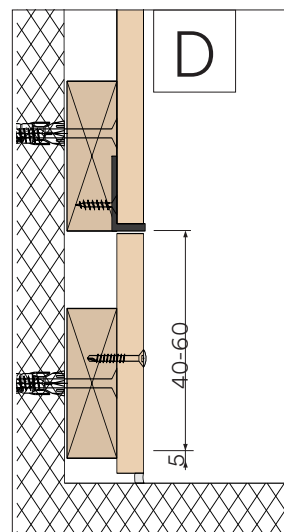
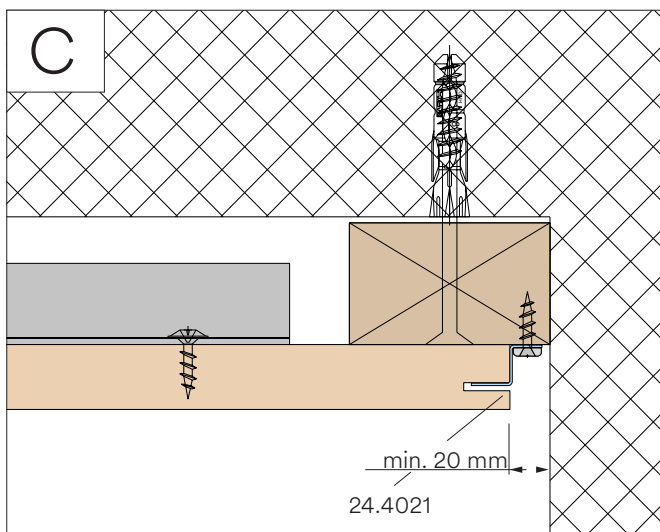
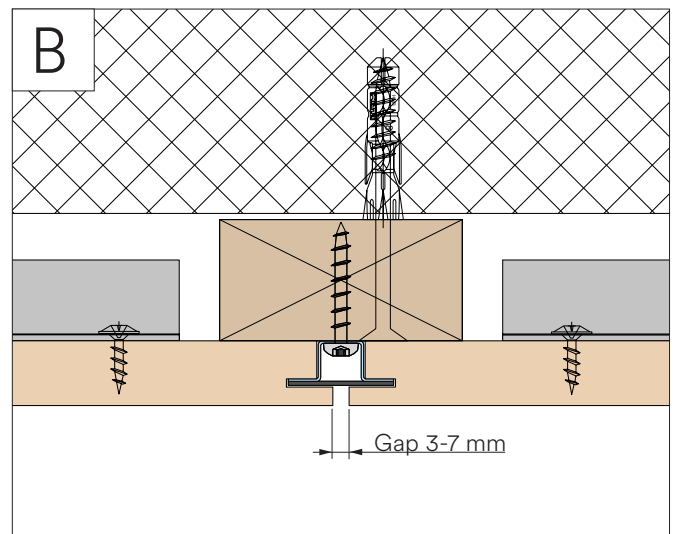
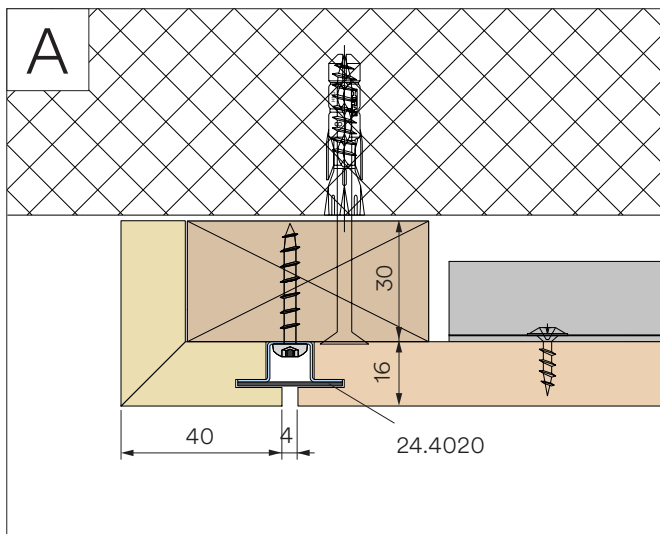
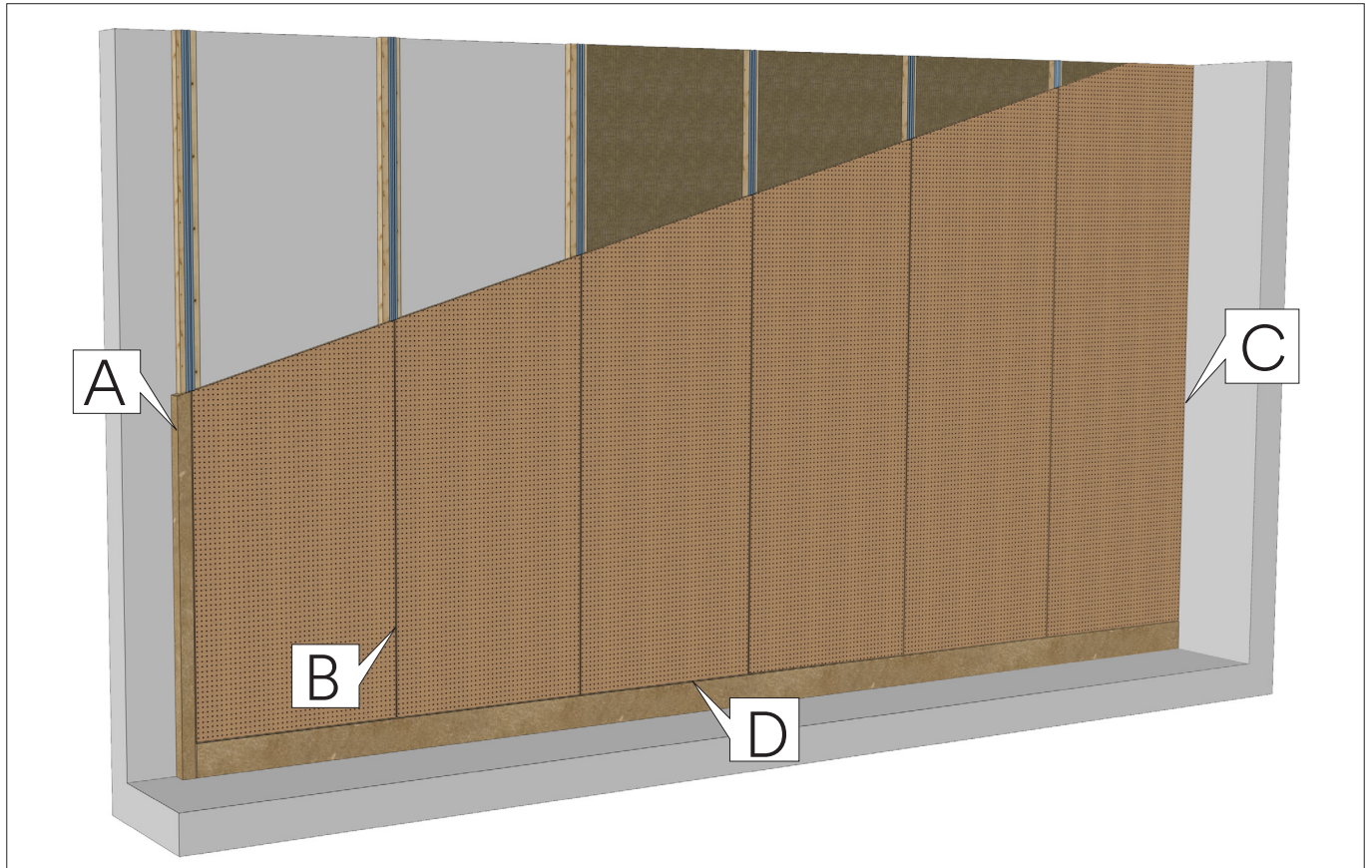

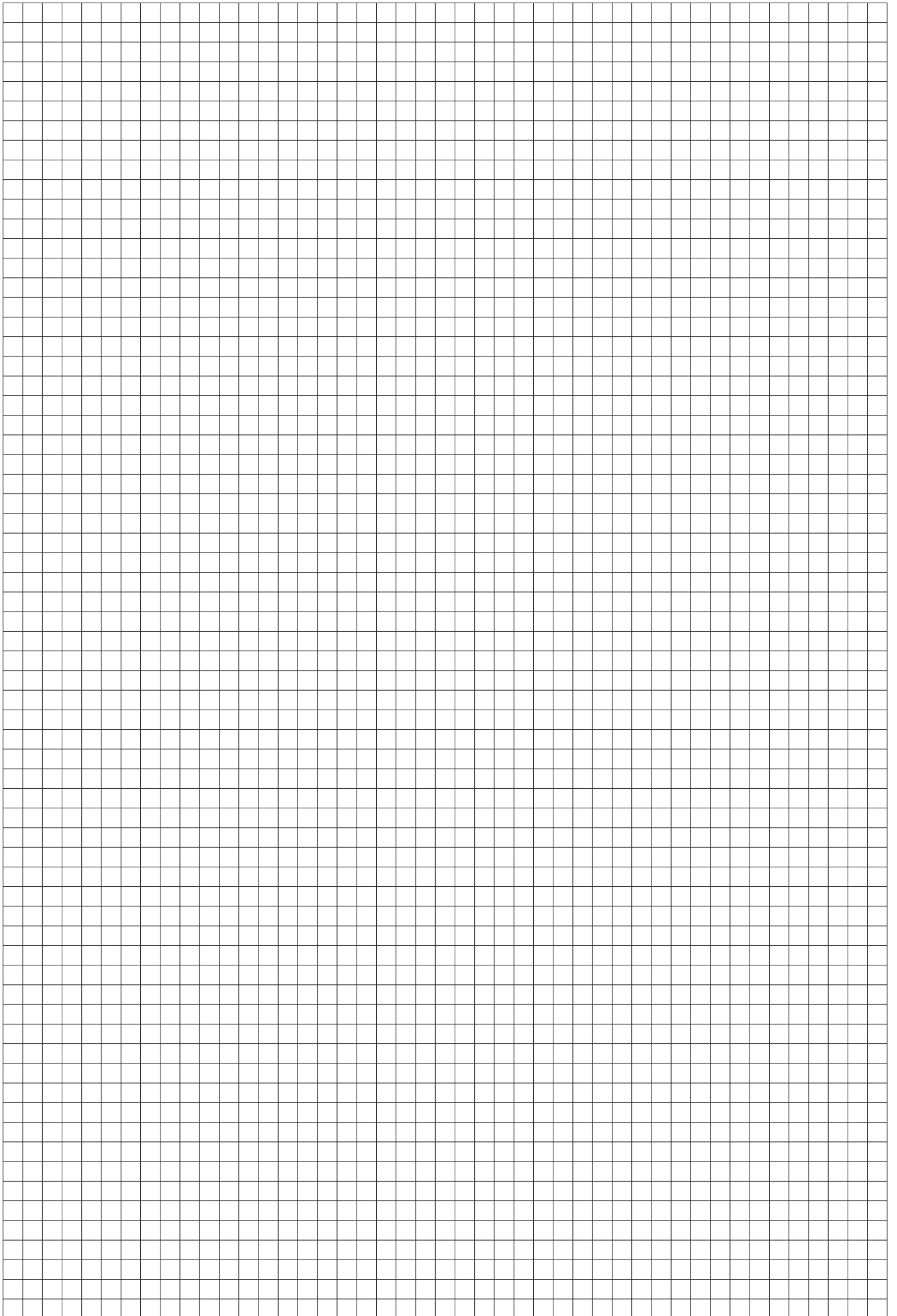

INSPIRED LISTENING

MORE INNOVATIVE DESIGNS AT:
WWW.TOPAKUSTIK.CH

TOPAKUSTIK IS A BRAND OF:

TOPAKUSTIK AG
OBSEESTRASSE 11
6078 LUNGERN
SWITZERLAND

CONTACT@TOPAKUSTIK.CH
WWW.TOPAKUSTIK.CH
T +41 41 679 73 73
F +41 41 679 73 79

