

# Acoustic Panel solutions

Product brochure

TOP)A)K)U)S)T)I)K) 

Acoustic panel solutions

Listening closely is in our nature. We hear subtle intertones and thus bring different sound worlds into perfect harmony.

Lake Lungern, view from Obsee to the north







Cholhüttli: Forest, Lungern







# Beauty meets performance

Sound plays a particularly important role wherever our senses perceive an environment as a whole. A pleasant indoor climate prevails wherever acoustics and design are in harmony. Topakustik not only delivers high-quality products, but also comprehensive and customised solutions to achieve this.

On the following pages, we are proud to present our revised Topakustik product range, as well as our additional services and skills. As before, our products can be configured to satisfy all your requirements in terms of function, form and aesthetics, meaning you can improve the quality of life in your rooms by appealing to both the eyes and ears.

This brochure features classic products such as the widely used Topakustik Classic 14/2, but if you really want to do your own thing and realise your own ideas, we also have a range of tailored options on offer. We search, plan, tinker and develop until we have found the right solution for you and your space. Please don't hesitate to contact us. Our motivated and experienced team of specialists from planning, technology and production see themselves as your partner when finding solutions, and are ready to rise to any challenge.

Together we can make your interiors sound more beautiful.

Marcel M. Müller  
CEO













Sadel Forest, Lungern





# Contents

	<b>Topakustik Solutions</b>	<b>8</b>		<b>Topakustik Solutions Supervision</b>	<b>66</b>
	<b>Topakustik Classic</b>	<b>10</b>		<b>Topakustik Grid</b>	<b>68</b>
	Topakustik Classic, basics	12		Topakustik Grid CHS	70
	Topakustik Classic, narrow grooves	14		Topakustik Grid G1	71
	Topakustik Classic, med-sized grooves	16		Topakustik Grid S11	71
	Topakustik Classic, wide grooves	18		<b>Topakustik Technology</b>	<b>72</b>
	Topakustik Classic R	20		Painted surfaces	73
	Topakustik Classic, special grooves	21		Veneered surfaces	74
				Melamine surfaces	75
	<b>Topakustik Solutions Engineering</b>	<b>26</b>		Medium density fibreboard (MDF)	76
	<b>Topakustik Perfo</b>	<b>28</b>		Special core panels	78
	Topakustik Perfo, basics	30		Edges	80
	Topakustik Perfo M	32		Cut-outs	80
	Topakustik Perfo T	33		Ceiling finishes	81
	Topakustik Perfo Clou	34		Wall corners and terminations	81
				Mounting Topakustik planks	82
	<b>Topakustik Solutions Manufacturing</b>	<b>38</b>		Mounting Topakustik panels	83
	<b>Topakustik Solutions Technology</b>	<b>48</b>		Gymnasia	84
				Swimming pools	84
	<b>Topakustik Micro</b>	<b>50</b>		<b>Topakustik Specials</b>	<b>86</b>
	Topakustik Micro	51		Topakustik cabinet fronts	86
	Topakustik Micro planks	53		Topakustik formed shapes	88
	Topakustik Micro Direct	54		Topakustik ARIA-Plus	90
	Topakustik Micro Graphic	55		Topakustik ARIA-Pure	91
	Topakustik Micro Print	55		<b>Topakustik Service</b>	<b>92</b>
	<b>Topakustik Custom</b>	<b>58</b>		Quality, Certificates	92
	Topakustik Custom Bubble	60		Sample boxes, Installation manual	93
	Topakustik Custom Split	60		Topakustik product names	94
	Topakustik Custom Graphic	61		Contact, Sales	95
	Topakustik Custom Line	62			
	Topakustik Custom Line Plus	63			



# Heading for perfection

Topakustik's products reveal their full potential as part of a system in particular. We see every room as a visually perceptible resonant body – a place where acoustics and design unite to create a pleasant indoor climate.

Every room is unique here, which calls for a tailor-made solution for every requirement. Our specialists cater to room-specific, architectural, acoustic, technical and aesthetic needs. We recognise the challenge and accept it. We look for and develop the optimal approach. We understand and optimise processes for planning, production and assembly. We are only satisfied when the solution is perfectly focused on the problem at hand. We are driven by a spirit of invention and innovation in meeting these new daily challenges.

Topakustik is your solution partner. We have expertise in engineering. We have a lot of experience in meticulous craftsmanship. We use state-of-the-art technologies and high-performance machinery. Finally, we are driven by our ambition to support every project beyond the delivery of our products, right up to the acceptance of the finished building.

Architects, general contractors, private building owners, ceiling builders, interior designers and joiners benefit from a comprehensive solution package. Our experts develop the perfect solution based on the individual list of requirements.





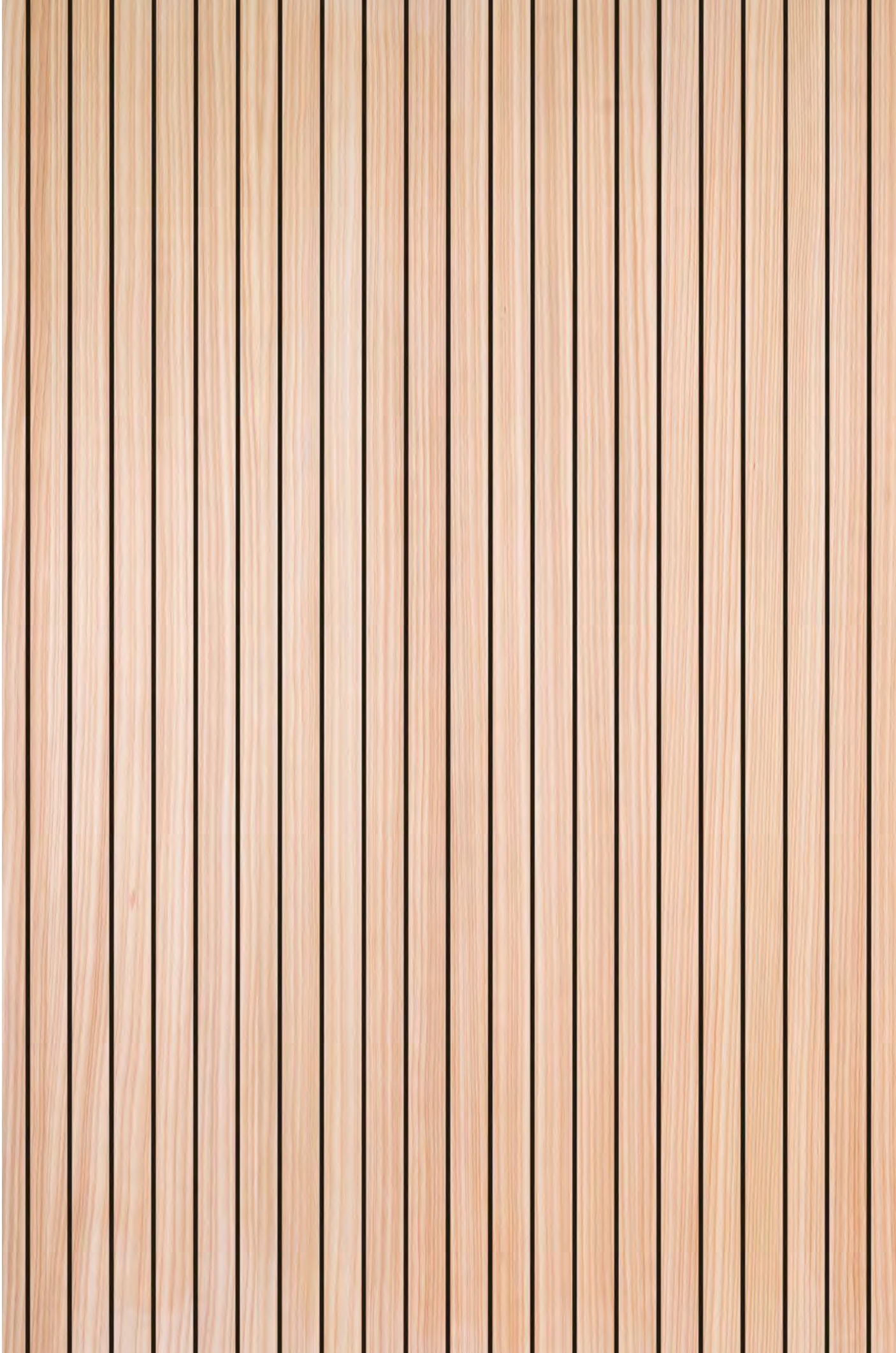



# Topakustik Classic



Topakustik Classic is the refined acoustic system for wall and ceiling finishes. Many different groove patterns are available. Thanks to the honeycombed rear perforation pattern, the core panel largely retains its stability. Cut-outs, for example, are possible anywhere.

## The acoustic system

All Topakustik types are available with different perforations on the rear. This makes it possible for the acoustic engineer to tailor the finishes optimally to the required absorption. The absorption values stated in this brochure comply with the ISO 354 standard. Additional certificates using other materials (e.g. only fleece, melamine resin foam, etc.) are available on request.



Structures with wide grooves and strong light-dark contrasts are particularly problematic when used horizontally.

### **Danger of flickering / moiré patterns!**

Recommendation: For wall finishes, use the following grooves (6/2, 8/3, 9/2, 14/2, 19/2, 29/3, 30/2).



To the product page with  
details and reference objects

# The acoustic system

## Measured according to ISO 354

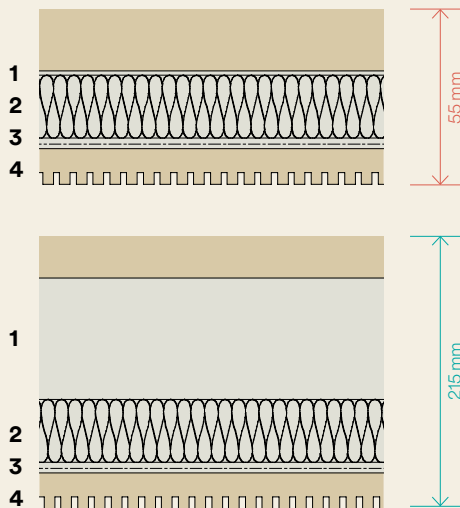

### Example

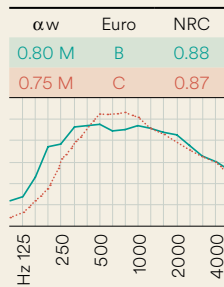

### Structure:

- 1 Variable air cavity
- 2 Mineral wool 30 mm (40 – 60 kg/m<sup>3</sup>)
- 3 Acoustic fleece SP 60, laminated
- 4 Topakustik element in 16 mm MDF

The sound absorption of our products is measured in a reverberation room in accordance with ISO 354:1985. This provides the  $\alpha_s$  values either listed in tabular form or plotted on a chart. You can find such charts in the descriptions of the individual products. The  $\alpha_w$  value given in the tables is the weighted sound absorption level that is calculated using a standardised method.

The classification into Euroclasses A, B, C, D and E is calculated and derived from the  $\alpha_w$  value (A = highest absorption capacity). The NRC (noise reduction coefficient) is the value specified in accordance with the US standard. Behind each  $\alpha_w$  value are the letters L, M and/or H to indicate if the sound absorption of the product is greater than 0.25 in the corresponding frequency range. L is for 250 Hz, M is for 500 Hz, and H is for 1000, 2000 or 4000 Hz.

## M-Perforation

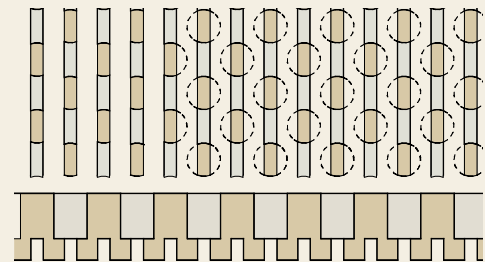

For high absorption in the medium to high-frequency range. Topakustik products with M-Perforation are suited for applications in which the reverberation time is to be lowered across the entire frequency band.

## T-Perforation

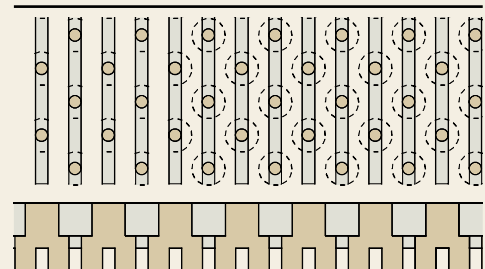

For high absorption in the low to medium-frequency range. The high absorption in the low-frequency range is based on the combination of small holes on the visible side and large holes on the rear.

## Reflectors

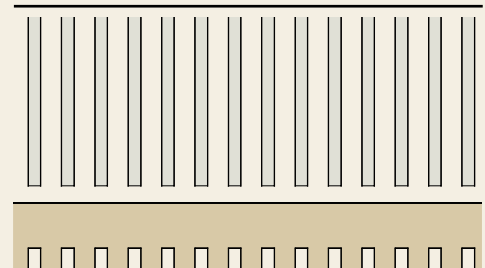

Topakustik elements can also be used as reflectors by eliminating the perforations on the rear. The absorption values are then equivalent to those of a standard reflecting panel.



# Dimensions and materials



## Planks

Thanks to the precise tongue-and-groove connection, planks create an attractive, seamless surface. The width of “only” 128 mm allows material expansion without this becoming visible in the joint. Installation is made on slatted frames using clamps or on T-bars with rotary clips (for assembly, see page 82).

Normally flammable D-s2,d0 / CH RF 3			Flame retardant B-s1,d0 / CH RF 2			RESAP® core panel, non-combustible		
Painted 16 mm	Real wood veneer 17 mm	Melamine 16 mm	Painted 16 mm	Real wood veneer 17 mm	Melamine 16 mm	Painted 16 mm	Real wood veneer 17 mm	
Standard = matched to MDF core sizes								
2780 × 128	2780 × 128	2780 × 128	2780 × 128	2780 × 128	2780 × 128	2540 × 128	2540 × 128	
				3640 × 128		3080 × 128	3080 × 128	
4080 × 128	4080 × 128*	4080 × 128	4080 × 128	4080 × 128*	4080 × 128			
Custom lengths are also available								

\* depending on wood type



## Panels

Panels are used for removable or structured ceiling and wall finishes. The larger width (compared to the planks) requires a joint between the panels in order to absorb the material expansion. Panels can be fitted with a number of different edges (page 80) and are thus also suited for cabinet fronts and room dividers.

Normally flammable D-s2,d0 / CH RF 3			Flame retardant B-s1,d0 / CH RF 2			RESAP® core panel, non-combustible		
Painted 16 mm	Real wood veneer 17 mm	Melamine 16 mm	Painted 16 mm	Real wood veneer 17 mm	Melamine 16 mm	Painted 16 mm	Real wood veneer 17 mm	
Standard = matched to MDF core sizes								
2040 × 992/640	2040 × 992/640	2040 × 992/640	2040 × 992/640	2040 × 992/640	2040 × 992/640	1540 × 608	1540 × 608	
2780 × 992/640	2780 × 992/640	2780 × 992/640	2780 × 992/640	2780 × 992/640	2780 × 992/640	2540 × 608	2540 × 608	
				3640 × 608		3080 × 608	3080 × 608	
4080 × 640	4080 × 640*	4080 × 640	4080 × 640	4080 × 640*	4080 × 640			
Custom lengths are also available – max. width depending on raw panel approx. 1200 – 1250 mm								

\* depending on wood type

### Interrupted grooves:

The grooves can be interrupted on panels. The edge can be chosen as required.



Further information on designs, dimensions and materials



Fire categories

Page 78



Page 73 – 75

# Topakustik Classic narrow grooves

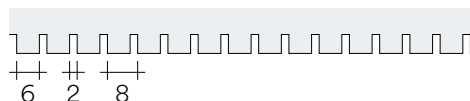
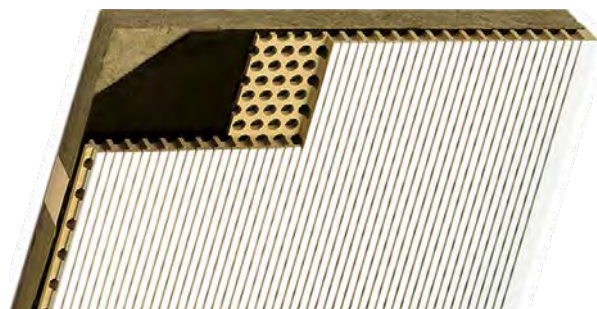

## Topakustik Classic 6/2 M or T

formerly: TOPAKUSTIK 6/2 M or T

### Centre-to-centre distance = 8 or 10.66 mm

Compared to wider grooves, this grooving is less visible as the interplay of light and shadow appears constant due to the narrow groove spacing and therefore appears more flat. The narrow grooves require perfect assembly, as even the smallest differences in the surface are visible.

**For dimensions and materials, see page 13**

**For surfaces, see pages 73 to 75**

### 6/2 M-7%

$\alpha_w$	Euro	NRC
0.85 M	B	0.91
0.80 M	B	0.86

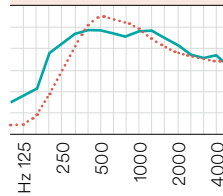

### 6/2 T

$\alpha_w$	Euro	NRC
0.40 LM	D	0.57
0.40 LM	D	0.62

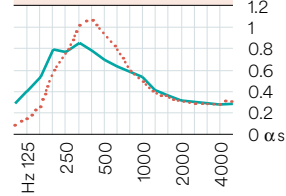

### Suspension height:

— approx. 216 mm

⋯ approx. 56 mm

See page 12 for more information.



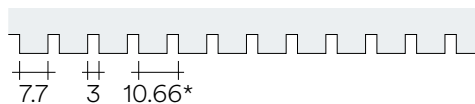
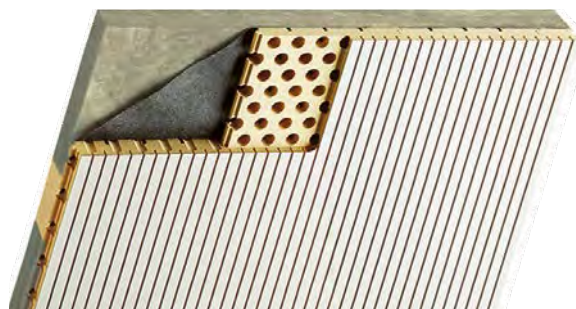

### Topakustik Classic 8/3 M

formerly: TOPAKUSTIK 8/3 M

### Topakustik Classic 9/2 M

formerly: TOPAKUSTIK 9/2 M

#### 8/3 M-19%

$\alpha_w$	Euro	NRC
1.00	A	1.00
0.70 MH	C	0.87

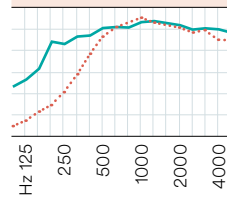

#### 8/3 M-9.5%

$\alpha_w$	Euro	NRC
0.85 L	B	0.92
0.80 M	B	0.85

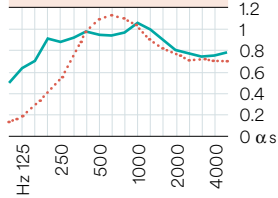

#### 9/2 M-6%

$\alpha_w$	Euro	NRC
0.80	B	0.82
0.75	C	0.80

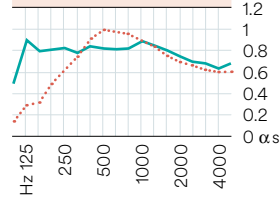

#### Suspension height:

- approx. 200 mm
- - - approx. 56 mm

See page 12 for more information.

#### Suspension height:

- approx. 216 mm
- - - approx. 56 mm

See page 12 for more information.

**!** \* Topakustik Classic 8/3 and 9/2:  
During planning, the axial dimension of  $10.\overline{66}$  mm must be taken into account.

# Topakustik Classic medium-sized grooves

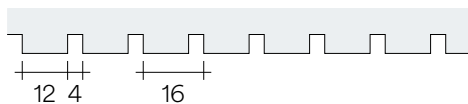
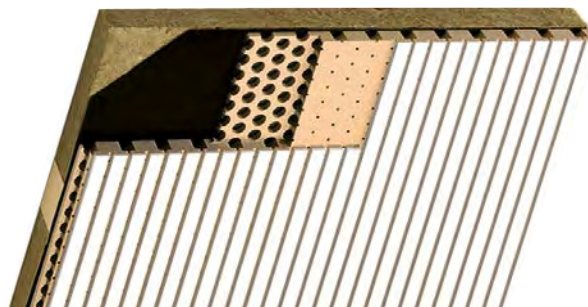

## Topakustik Classic 12/4 M

formerly: TOPAKUSTIK 12/4 M

### Centre-to-centre distance = 16 mm

The most popular Topakustik types. High sound absorption combined with easy assembly. The grooving remains visible even from a long distance.

**For dimensions and materials, see page 13**

**For surfaces, see pages 73 to 75**

### 12/4 M-15%

$\alpha_w$	Euro	NRC
0.80	B	0.89
0.80 M	B	0.86

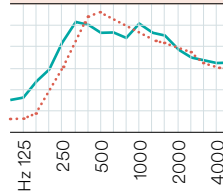

### 12/4 M-7.5%

$\alpha_w$	Euro	NRC
0.75 L	C	0.78
0.65 LM	C	0.77

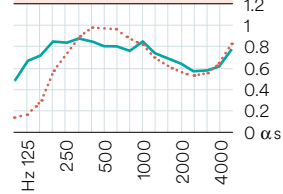

### Suspension height:

— approx. 223 / 246 mm

⋯ approx. 83 / 96 mm

See page 12 for more information.



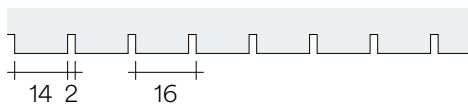
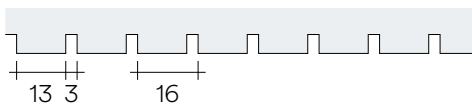

### Topakustik Classic 13/3 M or T

formerly: TOPAKUSTIK 13/3 M or T

### Topakustik Classic 14/2 M

formerly: TOPAKUSTIK 14/2 M

#### 13/3 M-12%

$\alpha_w$	Euro	NRC
0.90	A	0.89
0.85	B	0.85

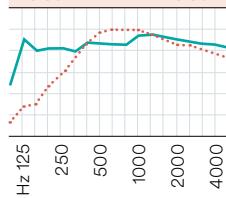

#### 13/3 M-6%

$\alpha_w$	Euro	NRC
0.65 L	C	0.71
0.60 LM	C	0.76

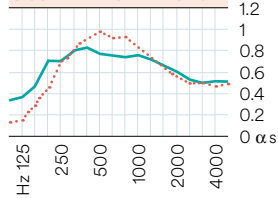

#### 14/2 M-7%

$\alpha_w$	Euro	NRC
0.90	A	0.89
0.85	B	0.86

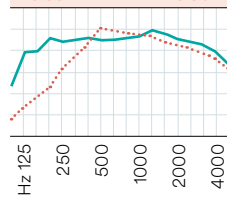

#### 14/2 M-3.5%

$\alpha_w$	Euro	NRC
0.75 L	C	0.74
0.65 LM	C	0.79

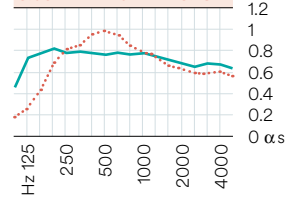

#### 13/3 T

$\alpha_w$	Euro	NRC
0.35 LM	D	0.57
0.35 LM	D	0.62

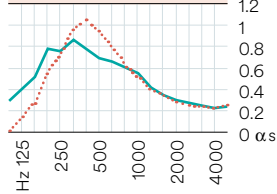

#### Suspension height:

- approx. 216 mm
- ⋯ approx. 56 mm

See page 12 for more information.

#### Suspension height:

- approx. 216 mm
- ⋯ approx. 56 mm

See page 12 for more information.

# Topakustik Classic wide grooves

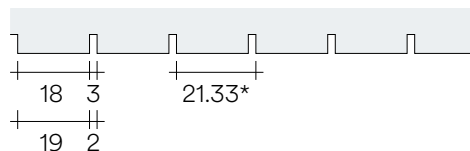

## Topakustik Classic 18/3 M & 19/2 M

formerly: TOPAKUSTIK 18/3 M & 19/2 M

### Centre-to-centre distance = 21.3 or 32 mm

These grooves are the ideal solution for standard absorption requirements. As with all centre-to-centre distances, the wide grooving also comes with 2 mm, 3 mm and 4 mm grooves.

**For dimensions and materials, see page 13**

**For surfaces, see pages 73 to 75**

### 18/3 M-8.5%

$\alpha_w$	Euro	NRC
0.80	B	0.83
0.80	B	0.83

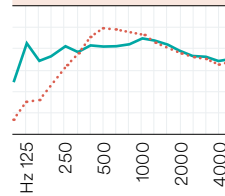

### 19/2 M-6%

$\alpha_w$	Euro	NRC
0.85	B	0.82
0.80	B	0.85

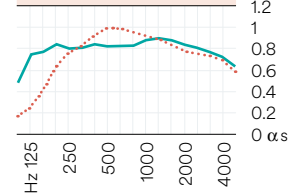

### Suspension height:

— approx. 216 mm

⋯ approx. 56 mm

See page 12 for more information.



\* Topakustik Classic 18/3 and 19/2:  
During planning, the axial dimension of 21.33 mm must be taken into account.

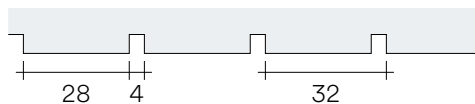

### Topakustik Classic 28/4 M or T

formerly: TOPAKUSTIK 28/4 M or T

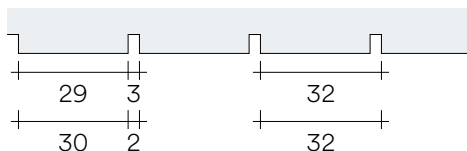

### Topakustik Classic 29/3 M & 30/2 M

formerly: TOPAKUSTIK 29/3 M & 30/2 M

#### 28/4 M-7.5%

$\alpha_w$	Euro	NRC
0.55 LM	D	0.78
0.55 M	D	0.72

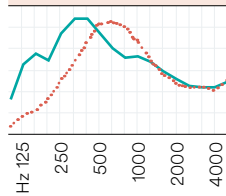

#### 28/4 M-3.75%

$\alpha_w$	Euro	NRC
0.50 LM	D	0.63
0.55 LM	D	0.69

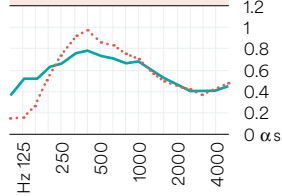

#### 29/3 M-6%

$\alpha_w$	Euro	NRC
0.65 L	C	0.73
0.60 LM	C	0.76

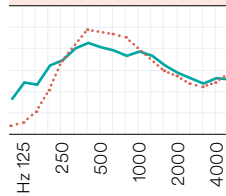

#### 30/2 M-3.5%

$\alpha_w$	Euro	NRC
0.55 LM	D	0.68
0.50 LM	D	0.72

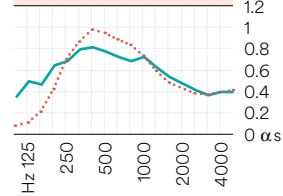

#### 28/4 T

$\alpha_w$	Euro	NRC
0.25 LM	E	0.41
0.25 LM	E	0.47

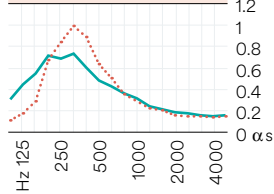

#### Suspension height:

— approx. 216 mm

⋯ approx. 56 mm

See page 12 for more information.

#### Suspension height:

— approx. 216 mm

⋯ approx. 46/56 mm

See page 12 for more information.



# Topakustik Classic R

## Centre-to-centre distance = 21.3 or 32 mm

The grooving pattern is irregular and therefore has its own unique appeal. On the planks, the grooving is repeated every 128 mm according to the system. Two (Type Duo) or even three (Type Trio) differently grooved planks increase the irregularity, especially if the assembly happens randomly.

R4 M-9.4%	$\alpha_w$	Euro	NRC
226 mm	0.80	B	0.82
56 mm	0.80	B	0.85

R3 M-7.4%	$\alpha_w$	Euro	NRC
226 mm	0.80	B	0.79
56 mm	0.75	C	0.82

R2 M-4.5%	$\alpha_w$	Euro	NRC
216 mm	0.70 L	C	0.74
56 mm	0.65 M	C	0.75

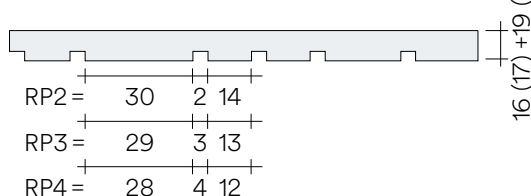
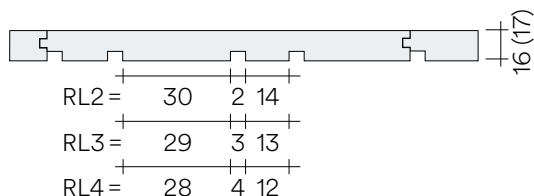

## Topakustik Classic R planks

formerly: TOPAKUSTIK-R

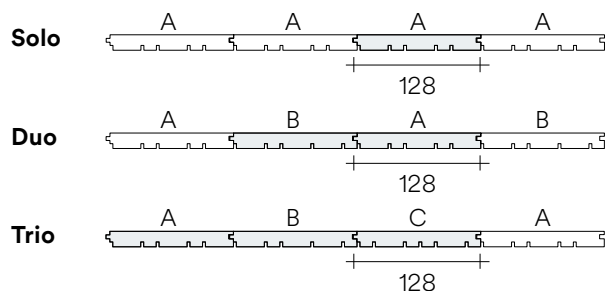

## Topakustik Classic R panels

formerly: TOPAKUSTIK-R

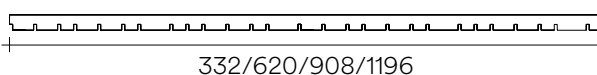

# Topakustik Classic special grooves

Topakustik also produces panels and planks with special grooves. These include the HR 9/2 M with semi-circular bars or a wider groove spacing with an axial dimension of 64 mm or 96 mm. Absorption values are available. Let us know more about your wishes.

HR 9/2 M-6%	$\alpha_w$	Euro	NRC
216 mm	0.75 L	C	0.82
56 mm	0.75 M	C	0.85
60/4 M-3.5%	$\alpha_w$	Euro	NRC
216 mm	0.45 L	D	0.53
56 mm	0.40 LM	D	0.55
61/3 M-3%	$\alpha_w$	Euro	NRC
226 mm	0.50 L	D	0.49
66 mm	0.45 L	D	0.51
93/3 M-2%	$\alpha_w$	Euro	NRC
226 mm	0.35 L	D	0.38
66 mm	0.35 L	D	0.39

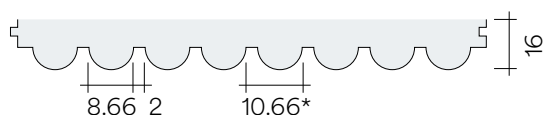
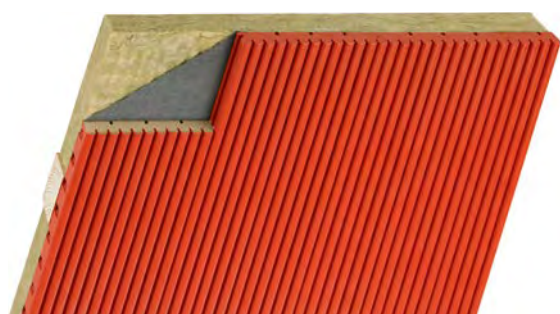

## Topakustik Classic HR 9/2 M

formerly: TOPAKUSTIK HR 9/2 M

### Surface finishes

 (painted only)

### Fire category

B-s1,d0 + D-s2,d0

### Planks

3800 × 128 mm

2600 × 128 mm



\* Topakustik Classic HR 9/2 M:  
During planning, the axial dimension of  $10.\overline{66}$  mm must be taken into account.









54 Rue de Londres, FR · Architect: Axel Schoenert Architectes, FR · Photo: Luc Boegly, FR · Product: Topakustik Classic, medium-sized grooves

Topakustik Classic











Camp Lakota, USA - Architect: Perkins + Will, USA  
Photo: Here And Now Agency + Paul Vu., USA - Product: Topakustik Classic, wide grooves



Jungheinrich company headquarters, Hamburg DE - Architect: Reichardt+Partner Architekten, Hamburg DE  
Photo: Walter-Schieswohl Fotografie, Hamburg DE - Product: Topakustik Classic, medium-sized grooves





# Engineering

## **Step by step to a tailor-made solution**

Some problems are not immediately solved, which is when that certain something extra is needed. Real innovations require a perfect combination of development and craftsmanship. The solutions for particularly complex problems are developed in Topakustik's in-house engineering department. Our goal here is to tinker until we find the answers to all open questions.

Our technicians and engineers are familiar with all aspects of timber construction technology. Once the list of requirements and initial outlines are in place, they get down to work immediately. The sketches are followed by a 2D plan, then a 3D plan. We then test the entire system using individual prototypes and build a true-to-scale mock-up. If the system meets all requirements in terms of functionality and quality, series production begins.



Bloomberg, The Vortex, London, UK · Architect: Foster + Partners, London UK · Photo: Nigel Young/Foster + Partners, London UK · Product: Topakustik Micro panels



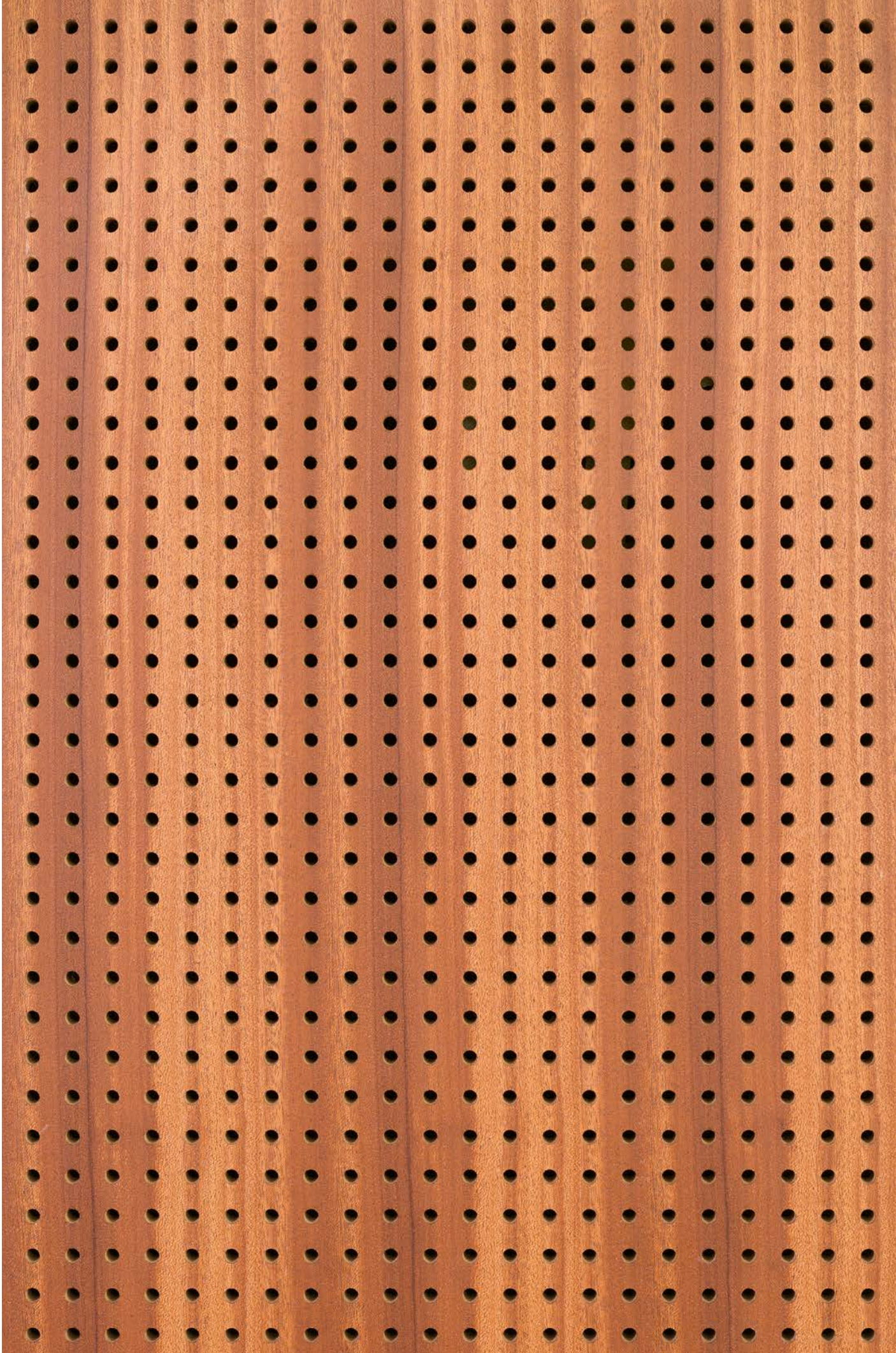



# Topakustik Perfo



Topakustik Perfo are perforated acoustic panels that are individually manufactured according to your wishes. Various hole diameters are available in different grids. Topakustik Perfo Clou are discreet in appearance while at the same time very effective in sound absorption thanks to the small hole diameters. Topakustik Perfo panels can be fitted with various edge designs. Hole-free edges or lamp fields are also possible.



To the product page with  
details and reference objects

## The acoustic system

All Topakustik Perfo types are available with different perforations on the rear. This makes it possible for the acoustic engineer to tailor the Topakustik Perfo finishes optimally to the required absorption. The absorption values stated in this brochure comply with the ISO 354 standard. Additional certificates using other materials (e.g. only fleece, melamine resin foam, etc.) are available on request.



Large perforation diameters can be problematic due to the strong light-dark contrast.

### **Danger of flickering / moiré patterns!**

Recommendation: For wall finishes, use the fine perforations (Topakustik Perfo T, Topakustik Perfo Clou or Topakustik Micro).

# The acoustic system

## M-Perforation

---

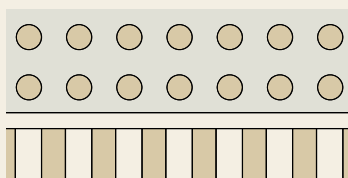

For high absorption in the medium to high-frequency range. The absorption depends on the degree of perforation on the acoustic elements, the absorption material applied to the rear, and the air cavity between the acoustic elements and the ceiling or wall.

## T-Perforation

---

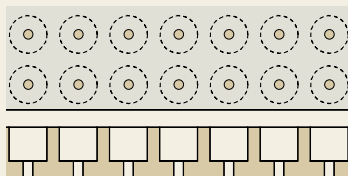

For high absorption in the low to medium-frequency range. The high absorption in the low-frequency range is based on the combination of small holes on the visible side and large holes on the rear. The small perforations and unobtrusive surface are particularly suitable for wall finishes.

## Reflectors

---

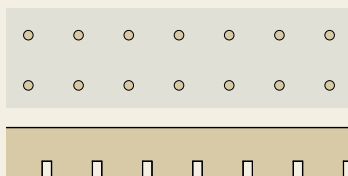

Topakustik Perfo elements can also be used as reflectors by having perforations that are not carried out continuously. The absorption values are then equivalent to those of a normal, non-perforated core panel.

## Clou-Perforation

---

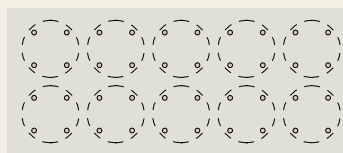

Clou Perforation in core panels with normal flammability. Developed on the basis of T-Perforation, the Clou Perforation features even smaller bore diameters starting at 1.2 mm. The sound energy is channelled through four bores on the visible side into one larger bore on the rear. Materials other than MDF can also be used as core panels.

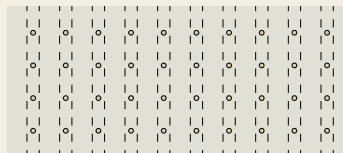









Clou Perforation in flame-retardant or non-combustible core panels. The bore on the rear side is replaced by a groove that has a slight influence on the absorption values (note the measurements). The perforation on the visible side remains the same on flame-retardant panels; the minimum diameter for non-combustible core panels is 2 mm.

# Dimensions and materials



## Panels

Normally flammable D-s2,d0 / CH RF 3			Flame retardant B-s1,d0 / CH RF 2			RESAP® core panel, non-combustible		
 Painted 16 mm	 Real wood veneer 17 mm	 Melamine 16 mm	 Painted 16 mm	 Real wood veneer 17 mm	 Melamine 16 mm	 Painted 16 mm	 Real wood veneer 17 mm	
Standard = matched to MDF core sizes								
2040 × 992/640	2040 × 992/640	2040 × 992/640	2040 × 992/640	2040 × 992/640	2040 × 992/640	1540 × 608	1540 × 608	
2780 × 992/640	2780 × 992/640	2780 × 992/640	2780 × 992/640	2780 × 992/640	2780 × 992/640	2540 × 608	2540 × 608	
				3640 × 608		3080 × 608	3080 × 608	
4080 × 640	4080 × 640*	4080 × 640	4080 × 640	4080 × 640*	4080 × 640			
Custom lengths are also available – max. width depending on raw panel approx. 1200 – 1250 mm								

\*depending on wood type

As of 2022 – current dimensions at [www.topakustik.ch](http://www.topakustik.ch)

## Edges

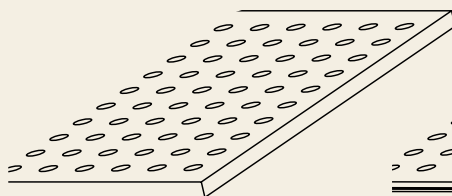

Clean cut

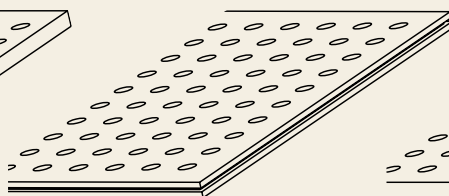

With surrounding tongue and groove

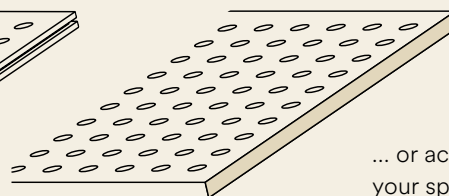

Visible edge

... or according to your specifications

## Mounting

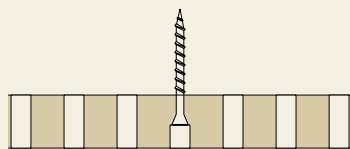

Topakustik Perfo M,  
Ø 6 mm  
Special screws: in half depth “dummy” perforations

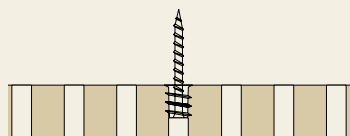

Topakustik Perfo M,  
Ø 8 mm  
Screwed through socket inserted at the rear

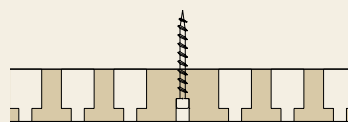

Topakustik Perfo T,  
Ø 4 + 5 mm  
Special screws: in half depth “dummy” perforations



**See installation manual!**

**Fire categories, page 78**



# Topakustik Perfo M

Acoustic panels in their conventional form in all materials and surfaces. Perforation-free edges and interrupted perforations for cut-outs of your choice.

**For dimensions and materials, see page 31**

**For surfaces, see pages 73 to 75**

## Grid dimensions and bore diameters

Axial dimension 16 / 20 / 40 mm

x	y	Ø	open area	ISO 354
16	16	6	12%	✓
16	16	8	19%	✓
16	16	10	31%	✓
20	20	6	7%	✓
20	20	8	12%	✓
20	20	10	20%	✓
40	40	10	5%	✓

... and many others!

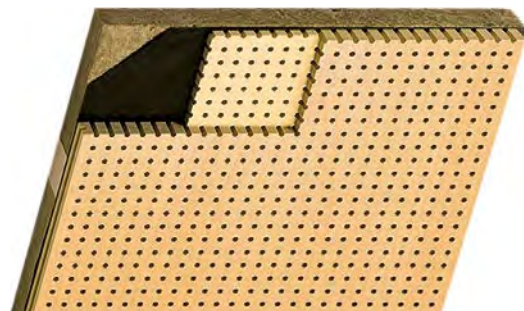
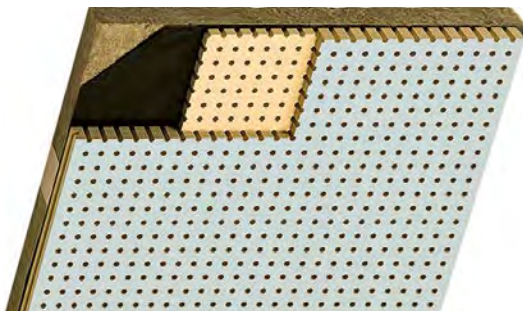

## Topakustik Perfo M 16/16/6

formerly: TOPPERFO-M 16/16/6

### 16/16/6-12%

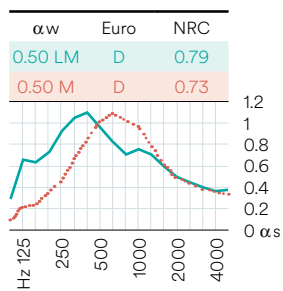

#### Suspension height:

— approx. 216 mm

⋯ approx. 46 mm

See page 12 for more information.

## Topakustik Perfo M 16/16/8 & 16/16/10

formerly: TOPPERFO-M 16/16/8 & 16/16/10

### 16/16/8-20%

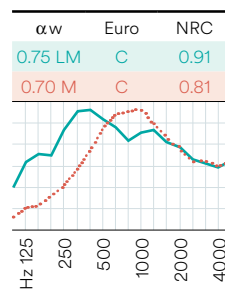

#### Suspension height:

— approx. 216 mm

⋯ approx. 46 / 56 mm

See page 12 for more information.

### 16/16/10-30%

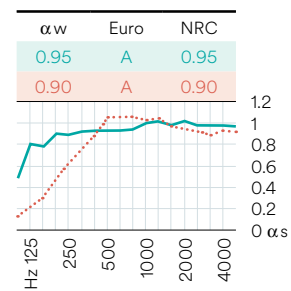

# Topakustik Perfo T

Developed and successfully used by Topakustik, the T-Perforation has a discreet effect while still offering high-performance absorption.

Topakustik Perfo T is available with perforation bores of 3, 4 and 5 mm. The smaller the visible perforations, the more the maximum absorption shifts to the lower frequency.

**For dimensions and materials, see page 31**  
**For surfaces, see pages 73 to 75**

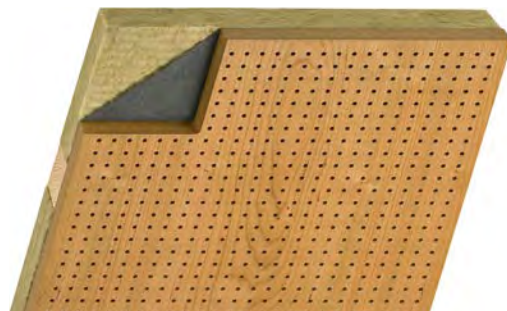

## Topakustik Perfo T 16/16/10-3 & 16/16/10-4

formerly: TOPPERFO-T 16/16/10-3 & 16/16/10-4

### 16/16/10-3

$\alpha_w$	Euro	NRC
0.40 LM	D	0.63
0.35 LM	D	0.68

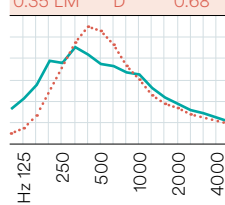

### 16/16/10-4

$\alpha_w$	Euro	NRC
0.55 LM	D	0.75
0.50 LM	D	0.78

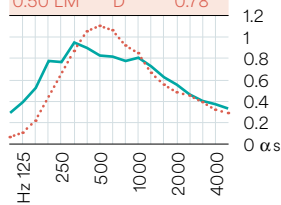

#### Suspension height:

- approx. 216 mm
- - - approx. 56 mm

See page 12 for more information.

## Topakustik Perfo T 16/16/10-5

formerly: TOPPERFO-T 16/16/10-5

### 16/16/10-5

$\alpha_w$	Euro	NRC
0.70 L	C	0.82
0.70 M	C	0.83

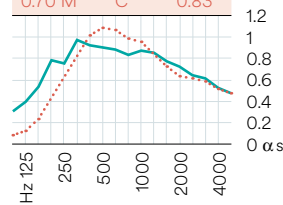

#### Suspension height:

- approx. 216 mm
- - - approx. 56 mm

See page 12 for more information.

# Topakustik Perfo Clou

The fine Clou Perforation is hardly visible from a distance. The wood structure is therefore largely preserved in its natural beauty.

**For dimensions and materials, see page 31**

**For surfaces, see pages 73 to 75**

Clou Perforations reach their full potential when carried out over the entire surface. The distance from the centre of the last row of perforations to the edge of the panel should therefore be as follows:

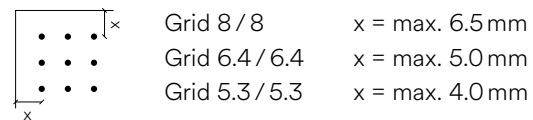

	Rear	8/8 6.4/6.4 5.3/5.3
Normally flammable MDF	perforated	Ø 1.2 mm Ø 2.0 mm
Flame-retardant MDF	grooved	Ø 2.0 mm
RESAP®	grooved	Ø 2.0 mm

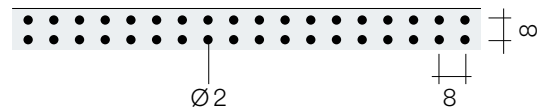
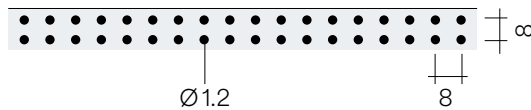
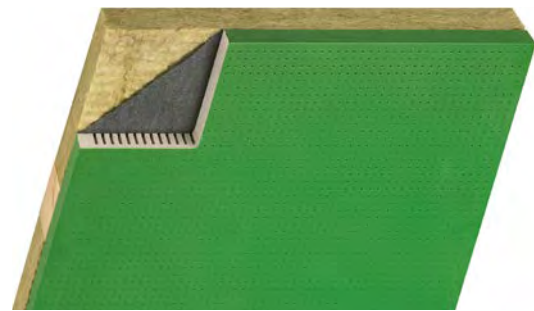

## Topakustik Perfo Clou 8/8/1.2

formerly: TOPPERFO-Clou 8/8/1.2

### 8/8/1.2 rear perforated

αw	Euro	NRC
0.30 LM	D	0.57
0.30 LM	D	0.60

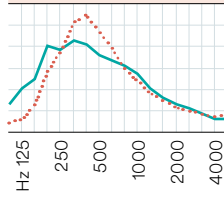

### 8/8/1.2 rear grooved

αw	Euro	NRC
0.25 LM	E	0.47
0.25 LM	E	0.52

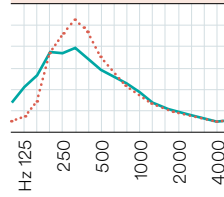

#### Suspension height:

- approx. 216 mm
- ⋯ approx. 56 mm

See page 12 for more information.

## Topakustik Perfo Clou 8/8/2

formerly: TOPPERFO-Clou 8/8/2

### 8/8/2 rear perforated

αw	Euro	NRC
0.45 LM	D	0.76
0.45 LM	D	0.75

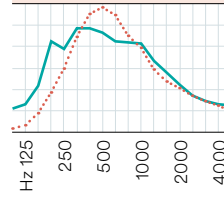

### 8/8/2 rear grooved

αw	Euro	NRC
0.55 LM	D	0.79
0.55 LM	D	0.81

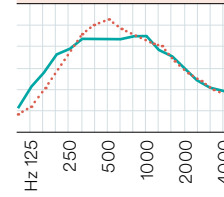

#### Suspension height:

- approx. 216 / 246 mm
- ⋯ approx. 76 / 96 mm

See page 12 for more information.





Marina South Parcel, SGP · Architect: Ingenhoven Architects, SGP  
 Photo: Soundzipper LLP, SGP · Product: Topakustik Perfo M

Topakustik Perfo



Coolidge Corner School, Brookline USA · Architect: HMFH Architects, Cambridge USA  
 Contractor: Whitehawk Construction Services, US · Photo: Ed Woneak Art Works Inc, Concord USA  
 Product: Topakustik Classic narrow grooves and Topakustik Perfo Clou



LVM Münster, DE - Architect: HPP Düsseldorf, DE  
Photo: HGEsch/Henref. - Product: Topakustik Perfo T



Witteveen + Bos., Deventer NL - Architect: Studio Groen+Schild, Deventer NL  
Photo: Barhey, Koog Zaandijk NL - Product: Topakustik Perfo T

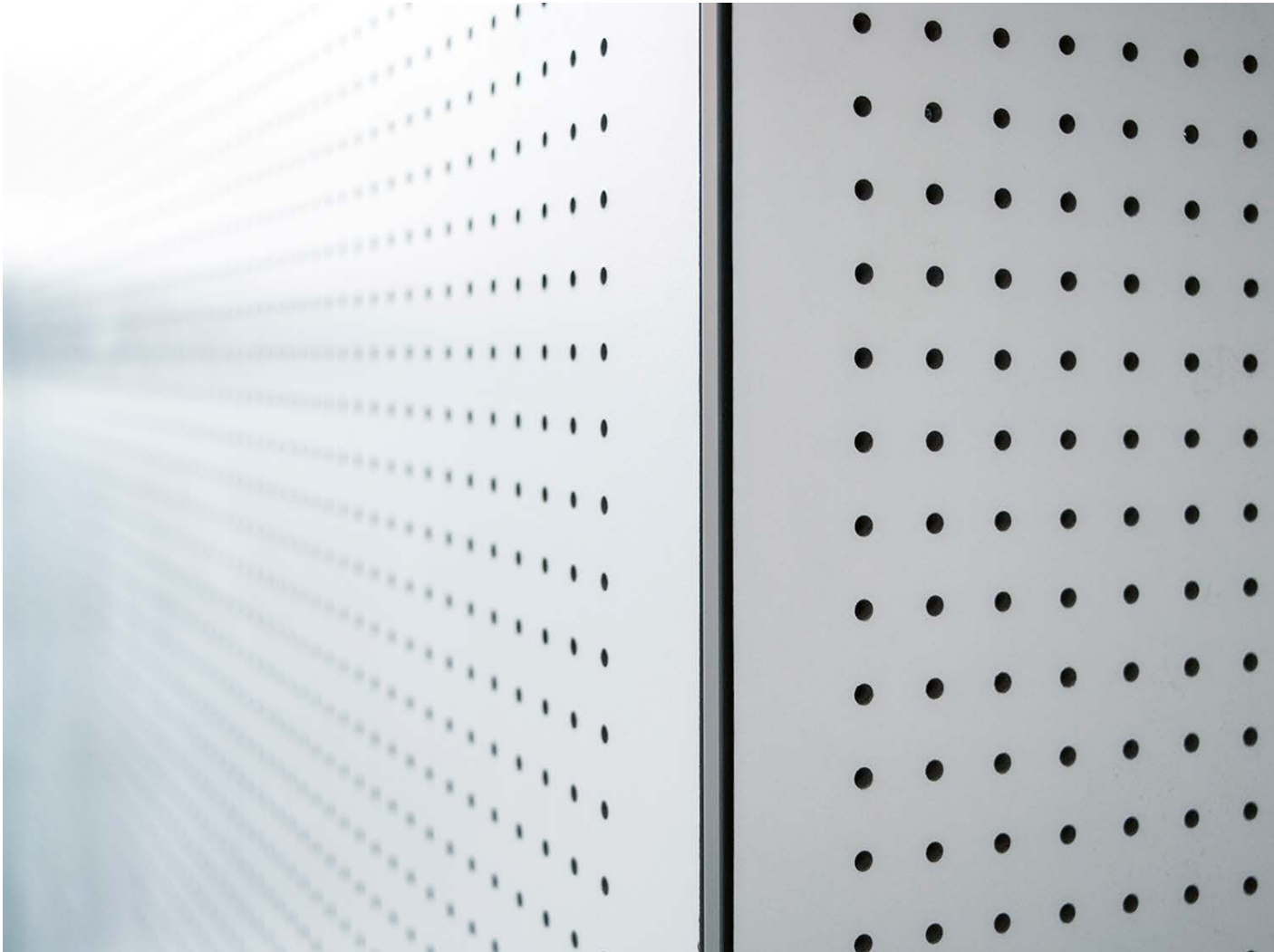





Sparkle, Twin Tower, Dubai UAE · Product: Topakustik Perfo M



Deaf Academy, GB · Architect: Stride Treglown Architects, GB · Assembly: Robert P Barry Ltd., GB  
Contractor: Midas Construction, GB · Product: Topakustik Perfo T



# Manufacturing

## **Each piece is handcrafted and unique**

The wall and ceiling systems from Topakustik impress thanks to their outstanding quality. Our trained joiners are exceptionally skilled and have many years of experience in working with wood. Every single panel and every single plank is shaped by hand and checked for even the smallest inconsistencies. This results in three-dimensional, custom-made, meticulously machined and refined individual parts that come together to form a convincing whole.

No machine can produce such special components. This complicated and detailed custom work can only be done by hand. Shaping, bending, surface treatment, edge processing and the final quality checks are therefore carried out by trained joiners. Every piece of an entire structure is one of a kind.

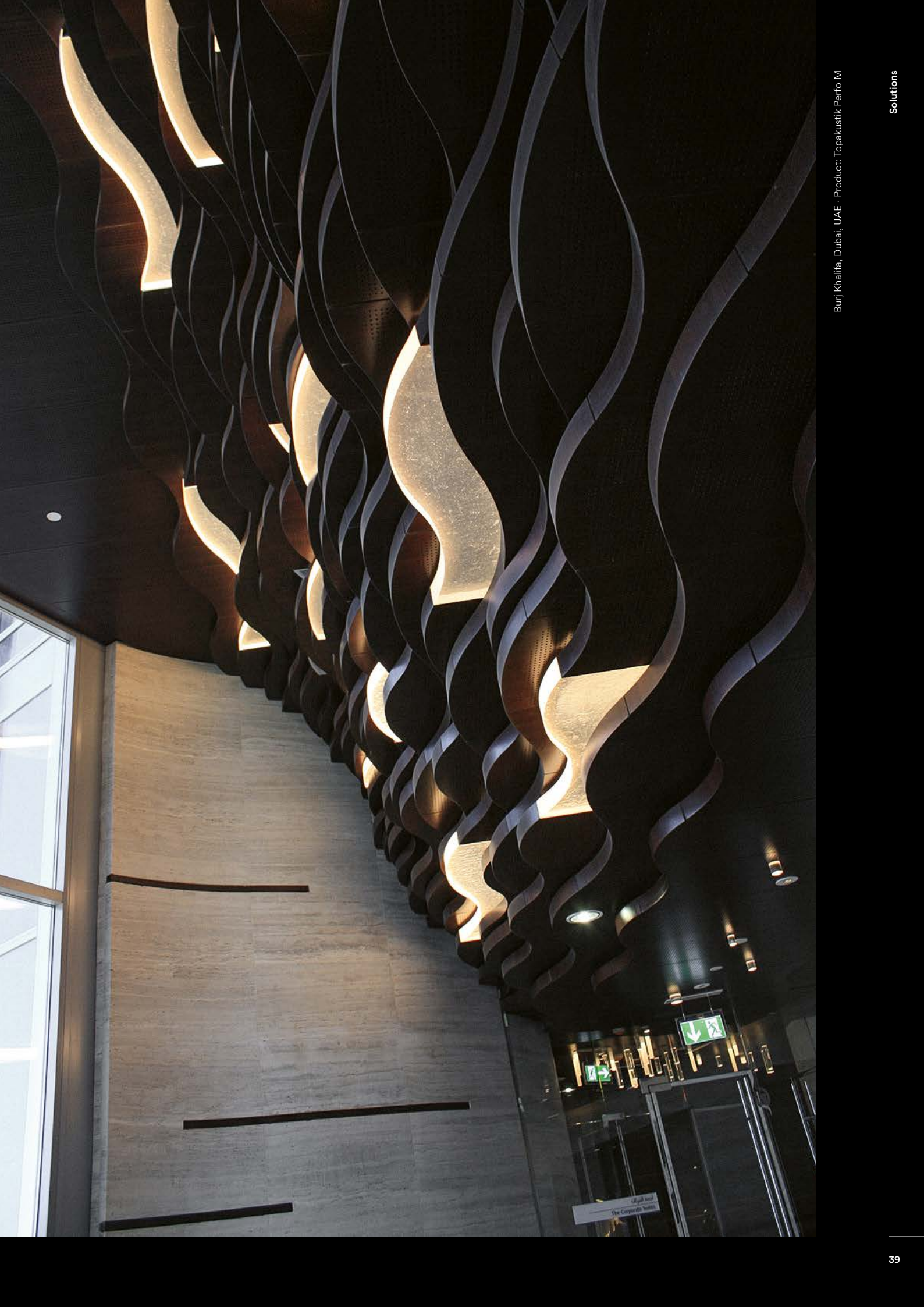





Whether the warmth of the wood or the fineness of the borehole, man and machine come together to create the elements that make your interiors sound more beautiful.





Cholhüttli Forest, Lungern





Wood meeting stone unleashes  
the unbridled power of nature.  
Meanwhile, tangible room  
quality is created where acoustics  
meet design.







Sadel Forest, Lungern





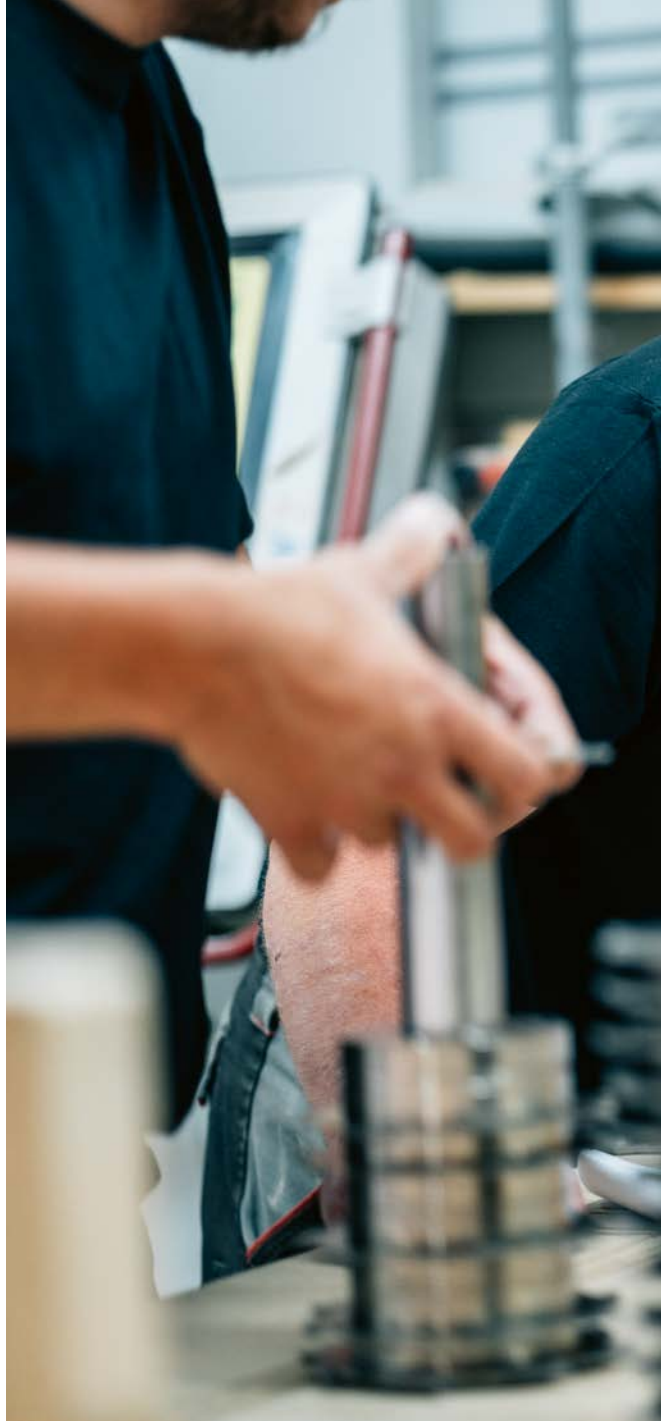
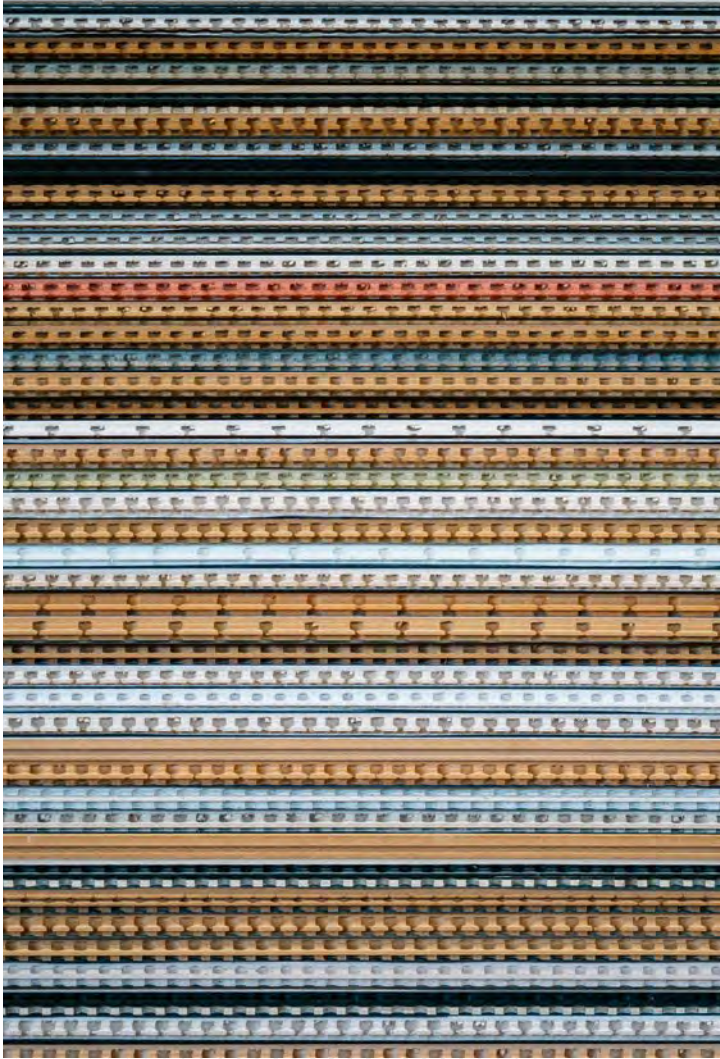



With a careful hand and a keen eye, the combination of acoustics and design takes shape.



Hear, see and feel – the senses bring together what belongs together.

Chälüttrank, Lungern

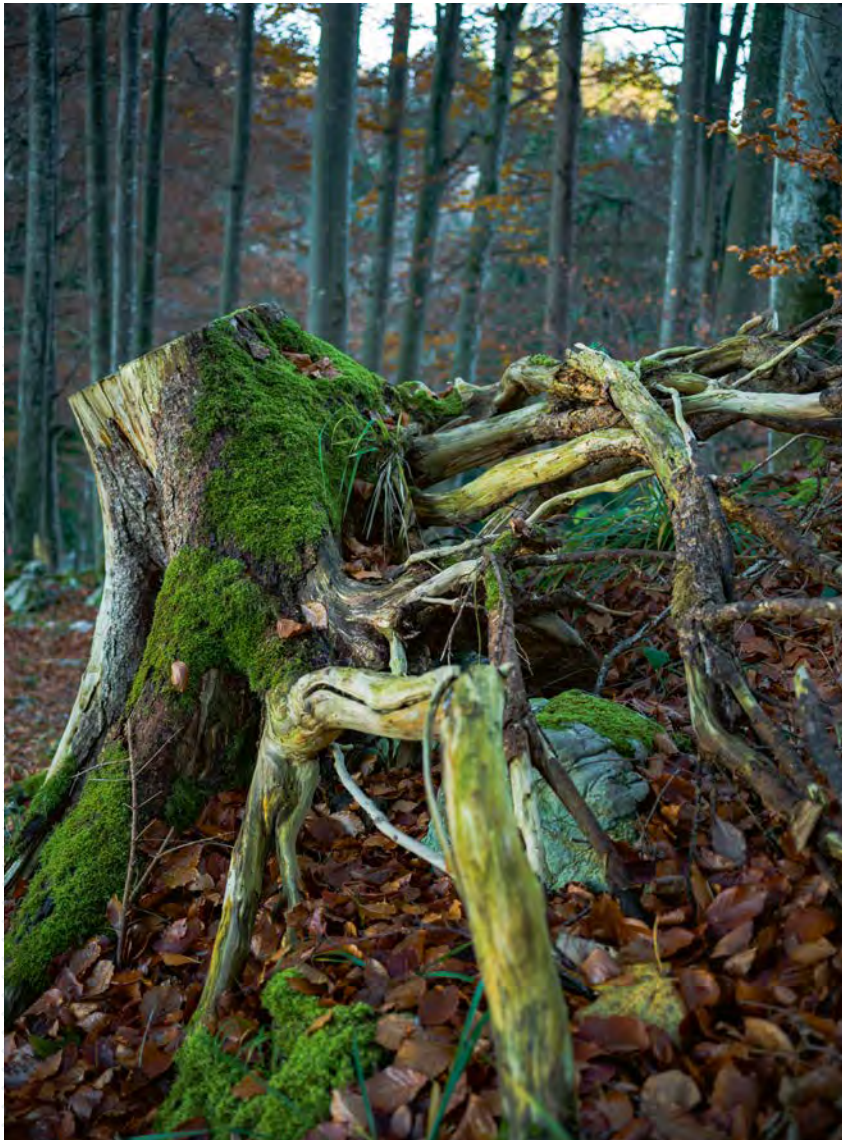





Craftsmanship creates the tangible, and inventiveness the perceptible.



# Technology

## **Performance and precision for maximum output**

At Topakustik, state-of-the-art technology and meticulous craftsmanship complement each other to create unique production processes. A high-performance machine park is used in serial production, cutting, surface treatment and when creating the absorption bores. This enables repetitive work steps to be carried out at maximum speed, which in turn optimises the logistics processes.

High-precision micro-laser technology opens up unimaginable possibilities when designing micro-perforated surfaces. The state-of-the-art spray robot stains, lubricates and paints surfaces at a surprising speed. Powerful cutting machines shape panels and individual components precisely and quickly. The machine prepares what the craftsman completes. This combination brings together top quality and maximum output.









# Topakustik Micro



Exclusive micro-perforation applications make Topakustik Micro a convincing solution for an invisible yet beautifully sounding indoor climate. Using state-of-the-art laser technology, the panels are micro-perforated with the finest pores according to individual requirements. The small hole diameters are discreet in appearance and simultaneously very effective in terms of sound absorption.



The perforation takes place in fields. On plain and dark surfaces in particular, it is possible for the transitions between the individual fields to be visible. The grid 1.8/1.8 is therefore not recommended for these surfaces. For a grid of 2/2, we recommend taking surface samples first.



To the product page with  
details and reference objects



# Topakustik Micro

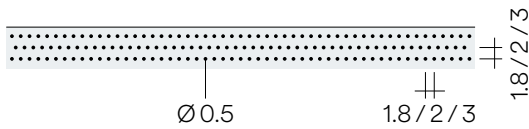

## Topakustik Micro 1.8/1.8/0.5 & 2/2/0.5 & 3/3/0.5

formerly: TOPPERFO-Micro

### 1.8/1.8/0.5

$\alpha_w$	Euro	NRC
0.90	A	0.93
0.90	A	0.95

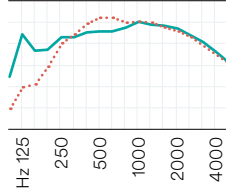

### 2/2/0.5

$\alpha_w$	Euro	NRC
0.80 L	B	0.93
0.75 LM	C	0.95

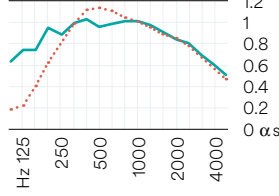

### 3/3/0.5

$\alpha_w$	Euro	NRC
0.60 LM	C	0.81
0.55 LM	D	0.84

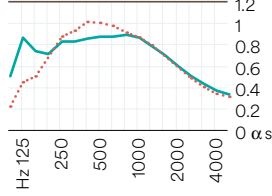

#### Suspension height:

— approx. 226 mm

⋯ approx. 66 mm

See page 12 for more information.

## Micro-Perforation

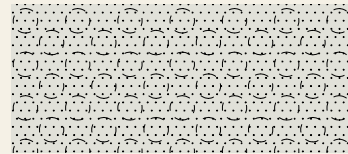

Micro-perforation impresses with high sound absorption without it being visible! The core panel is fully perforated and the covering, veneer or coating material is micro-perforated. Topakustik Micro is suitable for almost all surfaces, but not for outdoor applications.

#### Surface finishes



Paint according to RAL and NCS, Page 73



Real wood veneer (lengths depending on wood type), Page 74



Melamine coating according to eco collection 2.0, Page 75



Luma Hotel, USA · Architect: CCS Architecture, USA  
 Photo: Eric Laignel, USA · Product: Topakustik Micro planks

## Topakustik Micro planks 1.8/1.8/0.5 & 2/2/0.5

formerly: TOPPERFO-Micro planks

Topakustik Micro planks combine a thin belt design and sound absorption in a single product. Planks can be planned and also mounted very easily.

### Ideal lengths

MDF 16 mm B-s1,d0 (CH RF2):  
 2780 / 3640 / 4080 mm

MDF 16 mm D-s2,d0 (CH RF3):  
 2780 / 4080 mm

### Micro 1.8/1.8/0.5

$\alpha_w$	Euro	NRC
0.65 L	C	0.80
0.65 LM	C	0.84

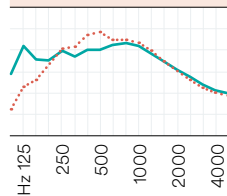

### Micro 2/2/0.5

$\alpha_w$	Euro	NRC
0.60 LM	C	0.76
0.60 LM	C	0.81

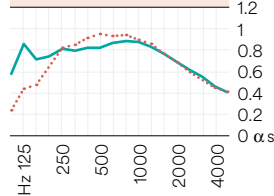

### Suspension height:

— approx. 226 mm

⋯ approx. 66 mm

See page 12 for more information.

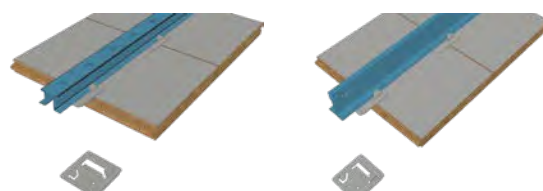

H-System with turning clip on H-bar

T-System with turning clip on T-bar

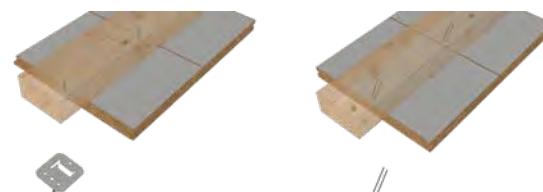

SC-System with screw clip on wooden batten or metal substructure

W-System with staple machine on wooden batten

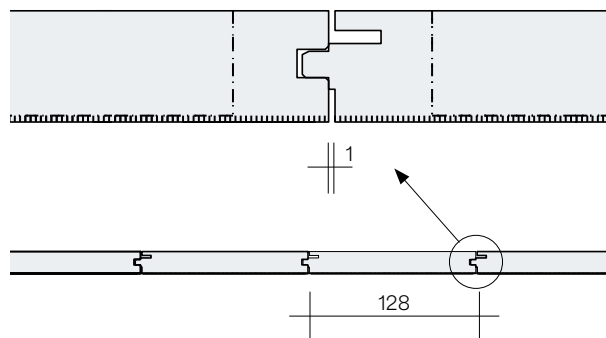





## Topakustik Micro Graphic

formerly: TOPPERFO-Micro Graphic

Using modern laser technology, graphic patterns and images are shot into the core panel. The appearance is created by omitting certain bores. Topakustik has a comprehensive catalogue of patterns and designs at its disposal. Individual designs are also possible. Whether a portrait, company logo or images with a 3D effect – the possibilities are almost unlimited.



HSS Monastery Banz, Bad Staffelstein DE · Architect: Architekturbüro F.A. Mayer, Rottach-Egern DE  
Photo: Architekturbüro F.A. Mayer, Rottach-Egern DE · Product: Topakustik Micro Graphic



To the product page with  
details and reference objects

## Topakustik Digital Print

Seehotel Europa, Wrann Hotel, 9220 Velden AT · Architect: Atelier Müller Fuchs, 8063 Hart AT  
Photo: Wolfgang Spitzer, Design- u. Akustiksysteme e.U., Attersee AT  
Product: Topakustik Micro with digital print



Topakustik Micro is also ideal for printed walls or ceilings. As the micro-perforation is almost invisible, it does not clash with the printed subject – but the surface still absorbs sound.

## Topakustik Micro Direct

formerly: TOPPERFO-Micro direct

Micro-perforation for almost all panels! We also turn industrially manufactured panels directly into sound absorbers! For example:

- Melamine-coated panels – see our eco collection on page 75
- Three-layer or solid panels
- MDF boards veneered by the joiner
- Coloured MDF panels, see page 79
- Plywood
- Fabric cover / wallpaper and more ...

83 Rue Richelieu, Paris FR · Architect: Jean Michel Wilmotte, FR  
Photo: Patrick Tourneboeuf / Tendance Floue, FR · Product: Topakustik Micro



reddot design award  
winner 2018



Hotel Kempinski Palace, Engelberg CH - Idea/concept/architect: Masswerk Architekten AG, Lucerne, Zurich / Graber Pulver Architekten AG, Zurich, Bern CH - Artistic direction for architecture: Hilmer Sattler Architekten Ahlers Albrecht, Munich DE  
Implementation of architecture: ARGE Architekturbüro Iwan Bühler GmbH, Lucerne / Sigrüst Schweizer Architekten AG, Lucerne CH  
Photo: Regine Giesecke, Zug CH - Product: Topakustik Micro



Restaurant Carne Mare, USA - Architect: Martin Brudnizki Design Studio, New York, USA  
Photo: Nicole Franzen, New York USA - Product: Topakustik Micro planks







Derendingen Mitte, CH · Architect: Erm + Heinzl Gesellschaft, von Architekten mbH, Solothurn CH  
 Photo: Stefan Müller Fotografie, Berlin DE · Product: Topakustik Micro

Topakustik Micro



Left: Flatiron Institute Auditorium, USA · Architect: Perkins Eastman, USA · Photo: Andrew Ruggie, USA · Product: Topakustik Micro  
 Right: 135 Bishopsgate, GB · Architect: Fletcher Priest Architects, London GB · Photo: Jack Hobhouse Photography, London GB  
 Product: Topakustik Micro







# Topakustik Custom



Topakustik Custom is the product you can design yourself. Perforated, with different hole sizes, grooved without continuous grooving, with longitudinal cuts, printed or micro-perforated with predefined designs – anything is possible. Our specialists would be happy to help you make your dreams become reality.



To the product page with  
details and reference objects



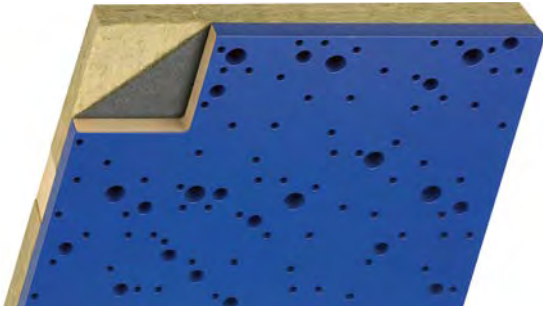

Three different bores

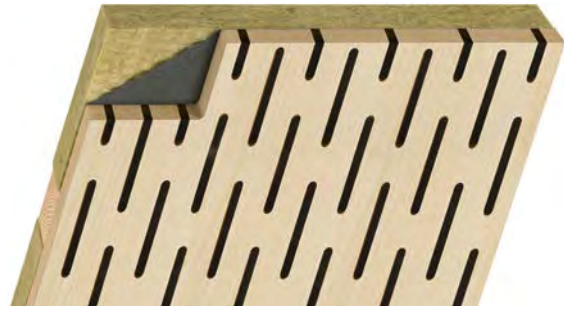

Longitudinal slots

## Topakustik Custom Bubble

formerly: TOPPERFO-Bubble

### Bubble 2.0-7 %

$\alpha_w$	Euro	NRC
0.50 L	D	0.50
0.50	D	0.51

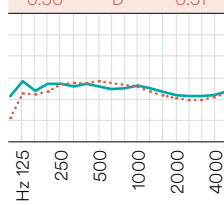

### Bubble 3.0-12.5 %

$\alpha_w$	Euro	NRC
0.65	C	0.64
0.70	C	0.64

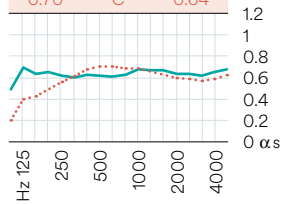

#### Suspension height:

- approx. 216 mm
- ..... approx. 56 mm

See page 12 for more information.

## Topakustik Custom Split

formerly: TOPPERFO-Split

### Split 96/32/72-8

$\alpha_w$	Euro	NRC
0.80	B	0.77
0.80	B	0.73

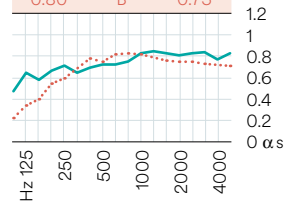

#### Suspension height:

- approx. 200 mm
- ..... approx. 56 mm

See page 12 for more information.



## Topakustik Custom Graphic Uno

formerly: TOPPERFO-Graphic

Individual perforations are omitted to create a graphic pattern. Some applications are shown on this page, but the possibilities are almost unlimited. The only rule is that the bore grid of 16 mm must always be observed. Sound absorption values are available for “minus 20%” and “minus 40%” of the perforation.

## Topakustik Custom Graphic Multi

formerly: TOPPERFO-Graphic Multi

Multiple bore diameters offer considerably more possibilities, but are also more demanding in terms of production.

### 16/16/8-15 % “minus 20 %”

$\alpha_w$	Euro	NRC
0.75	C	0.72
0.75	C	0.70

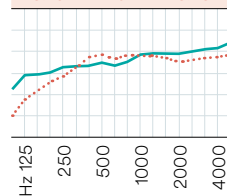

### 16/16/8-11 % “minus 40 %”

$\alpha_w$	Euro	NRC
0.65	C	0.61
0.65	C	0.60

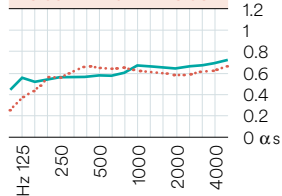

#### Suspension height:

- approx. 200 mm
- ⋯ approx. 56 mm

See page 12 for more information.



# Topakustik Custom Line



reddot winner 2021  
best of the best

## Sound absorption redesigned

---

- A completely new concept through ornamental designs instead of perforations or grooving
- Virtually limitless individualisation thanks to almost any design on nearly any surface

## Surface finishes

---



### Paint

All except white and very light colours (after consultation)



### Real wood veneer

All types of wood (light veneers must be sampled)



### Melamine coating

Our Eco collection 2.0 (only with MDF), HPL coating on request

## Award-winning product design

---

The Red Dot Design Award is one of the world's most important design competitions. Topakustik Custom Line was announced as the winner of the highest award, the "Best of the Best 2021". According to the jury, Topakustik gives sound-absorbing wall and ceiling finishes an entirely new aesthetic. The idea of aesthetising this area with different graphic ornaments opens up a lot of freedom for individualisation in architecture. The underlying concept is impressive in its logic as well as its high-quality implementation. It takes away the anonymity of an acoustic panel and instead gives it visually attractive qualities.



To the product page with  
details and reference objects



## Core materials

- MDF 16 mm normally flammable D-s2,d0 and flame retardant B-s1,d0
- RESAP® 16 mm, non-combustible
- Three-layer panel ARIA-Pure (white fir) 16 mm

## Topakustik Custom Line Plus

formerly: TOPAKUSTIK Line

Each motif can be supplemented with micro-perforation across the entire surface. This increases the sound absorption values to those of our Topakustik Micro product.

## Formats

- max. 4000 × 1280 mm

The external dimensions depend on the pattern. Note the axial dimensions of the pattern horizontally and vertically, which are assigned to each of the different designs.

### Custom Line 2112

αw	Euro	NRC
0.60 LM	C	0.76
0.60 LM	C	0.82

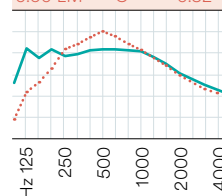

### Custom Line Plus 2/2/0.5

αw	Euro	NRC
0.80 L	B	0.93
0.75 LM	C	0.95

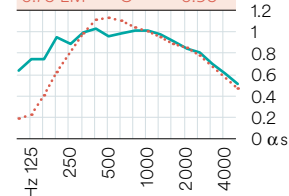

### Suspension height:

- approx. 200 / 226 mm
- ..... approx. 56 / 66 mm

See page 12 for more information.



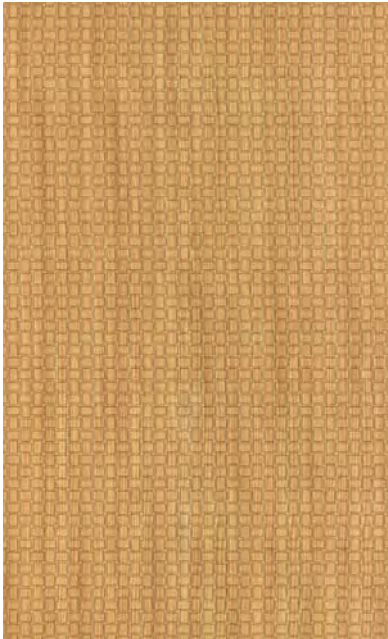

## Topakustik Custom Line 2112

formerly: TOPAKUSTIK LINE 2112

Pattern	w = 58 mm h = 58 mm		
$\alpha$ w	Euro	NRC	
0.60 LM	C	0.76	
0.60 LM	C	0.82	

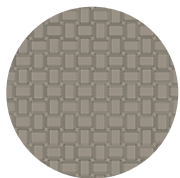
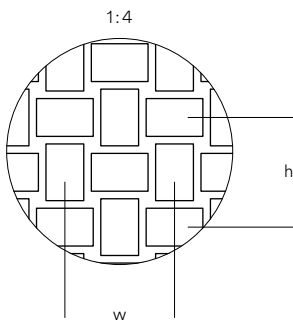

Grey

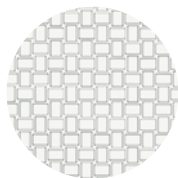

White

## Topakustik Custom Line 2110

formerly: TOPAKUSTIK LINE 2110

Pattern	w = 236.68 mm h = 236.68 mm		
$\alpha$ w	Euro	NRC	
0.70 L	C	0.81	
0.70 LM	C	0.86	

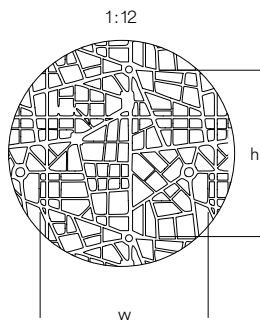

## Topakustik Custom Line 2121

formerly: TOPAKUSTIK LINE 2121

Pattern	w = 140 mm h = 192 mm		
$\alpha$ w	Euro	NRC	
0.70 L	C	0.79	
0.65 LM	C	0.85	

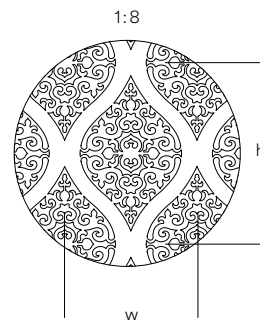

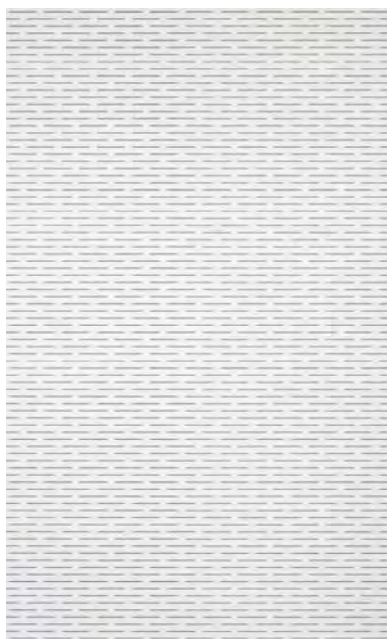
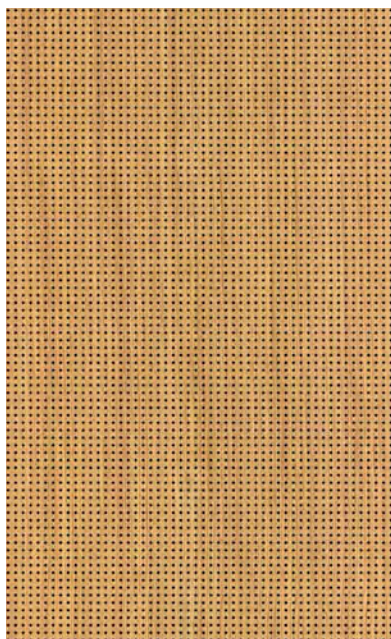

### Topakustik Custom Line 2113

formerly: TOPAKUSTIK LINE 2113

Pattern	w = 16 mm h = 16 mm		
	$\alpha_w$	Euro	NRC
	0.75	C	0.72
	0.75	C	0.70

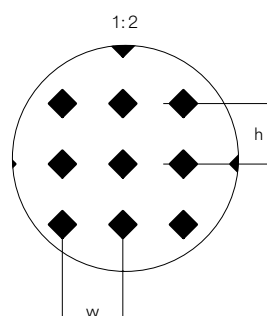

### Topakustik Custom Line 2111

formerly: TOPAKUSTIK LINE 2111

Pattern	w = 50 mm h = 20 mm		
	$\alpha_w$	Euro	NRC
	0.50 LM	D	0.72
	0.50 LM	D	0.77

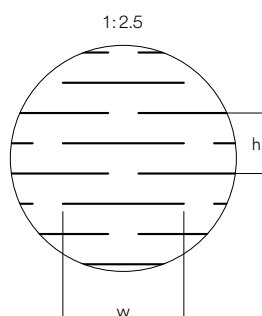

### Topakustik Custom Line 2115

formerly: TOPAKUSTIK LINE 2115

Pattern	w = 202.50 mm h = 116.913 mm		
	$\alpha_w$	Euro	NRC
	0.75 L	C	0.85
	0.75 M	C	0.90

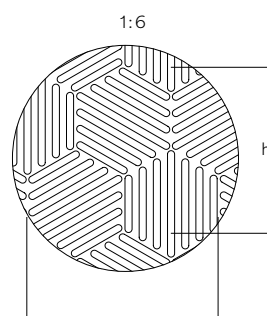

#### Create your own design

If you can't find what's right for you, you can easily create your own design. Send us your DXF file – we'll be happy to check it out. Soon you'll have your very own sound-absorbing wall or ceiling finish.



More designs can be found in our flyer or on the website.



# Supervision

## **Trained and supervised by experts**

Topakustik develops, manufactures and delivers comprehensive solutions for acoustic wall and ceiling constructions. On-site installation is not included in the Topakustik package. In order to provide staff with the best possible support, our specialists take on the on-site instruction and training of the tradespeople.

Customised, complex solution packages in particular require specific expertise during assembly. To ease the burden on the building owner, our engineers provide basic theoretical training and practical training for the assembly staff on the construction site. We have the necessary experience in the application of our products and solutions. With our structured quality management system, we guarantee professional instruction throughout the assembly process and ensure safe processes.









# Topakustik Grid



## Sub-constructions for panels and planks

---

Topakustik develops acoustic constructions as coherent system solutions. This also includes concealed sub-constructions. These enable the simple assembly and uncomplicated disassembly of individual panels or planks. Topakustik also offers tailor-made solutions for sub-constructions. This creates maximum flexibility in terms of room height, maintenance of concealed installations, architectural requirements and desired installation types.

- Tailor-made systems that match the panels and planks
- Easy installation
- Dismantling of individual elements for maintenance work
- Fire protection, earthquake protection
- Limitless design possibilities (2D, 3D)
- Ceiling planning
- Consultation



[Go to product page](#)





## Mounting

---

Topakustik Grid sub-constructions enable the simple and flexible installation of even large-scale ceiling finishes. Planning is carried out in close coordination with the panels and planks used. Each system is a tailor-made solution.

## Dismantling

---

Each structure is put together in such a way that even individual panels can be easily removed. This makes it easier to access and maintain concealed installations.

## Safety

---

The Topakustik Grid product line meets the highest safety standards. Topakustik Grid G1 and Topakustik Grid CHS have been tested for fire protection and fall safety. Additionally, Topakustik Grid S11 also takes into account all requirements for earthquake safety.

## Topakustik Grid CHS

---

- Can be used on large-scale ceiling layouts (panel widths up to 1248 mm)
- Easy mounting of the sub-construction via grid system
- Can be installed in parallel and English patterns
- Medium installation height necessary
- Ideal for all Topakustik panels

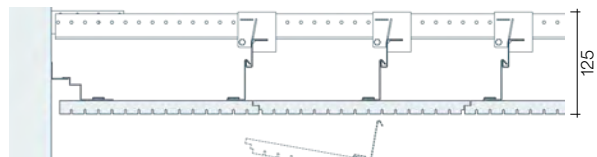



## Topakustik Grid G1

- Each panel can be opened by lifting and pulling downwards
- Simple sub-construction with minimal parts
- Individual panel widths up to 768 mm possible
- Low installation height necessary
- Can be installed in parallel and English patterns
- Joint at least twice as large as the acoustic groove

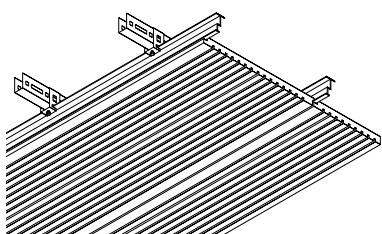
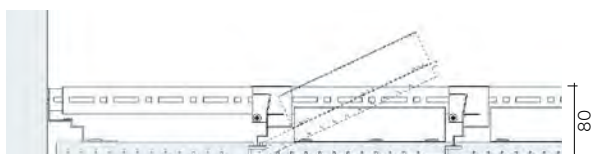

## Topakustik Grid S11

- Earthquake-proof according to ASCE 7-10 & IBC 2012
- Each panel removable for easy maintenance work
- Ceiling can be easily opened and closed again by means of a spring system
- Ideal for Topakustik panels
- Grid panel widths up to 768 mm possible
- Sub-construction in grid system suitable for Topakustik products
- Can be installed in parallel and English patterns

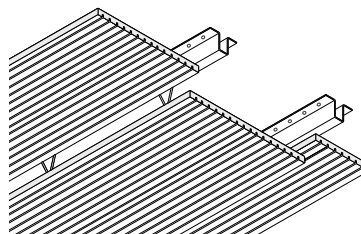
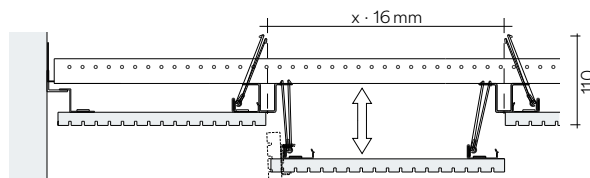





# Topakustik Technology



Topakustik products are available with different surface finishes. Whether veneered, painted or coloured, the design possibilities are almost limitless. The colour, surface properties, materials and finish mean the wall and ceiling finishes from Topakustik ensure unique interior design.

## White or coloured painted surfaces

---

Water-based paints are used as standard, which meet the highest demands in terms of environmental friendliness and mechanical values. The colour specification according to RAL or NCS serves as the basis. Painting is carried out using state-of-the-art spray robots, which guarantees uniform application.

### Painting

Painting is carried out with high-quality water-based paints or according to customer requirements, e.g. waxed, oiled or with other coating systems. Light wood types such as maple or birch have a slightly lightened paint finish as standard.

NM = natural, matt finish

AM = lightened, matt finish



Painted surfaces have the advantage that the grooves are also of the same colour.



Eco coatings make the grooves stand out more clearly.





Collection 20 – 9 (subject to a nominal fee)  
 20 coloured natural wood veneers and  
 9 natural wood veneers

... and many other types of wood



## Surfaces with real wood veneer

Topakustik elements are veneered in all common wood types. The veneers are processed individually by order to obtain the most uniform appearance possible in colour and grain. The veneer appearance is also influenced by the cut and assembly. Wood is a natural product, meaning it is not possible to define generally applicable rules and standards for the veneer. The veneer must be matched in connection with each individual order.



Different lengths of planks or panels: The veneer is selected according to the length of the planks or panels. Different veneers can then be used for various lengths. If the whole order needs to be produced with the same veneer (higher veneer offcuts), this must be stated as a condition.

Rift veneers (strip veneer or true quarters) on panels: Joining rift veneers is not recommended for certain types of wood such as maple or cherry, as this results in a striped veneer pattern. We recommend sliding and mixing the veneer, as seen in our “Random matched” range.



European Oak

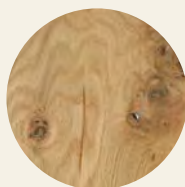

Knotty Oak



Oak Optic ST2002

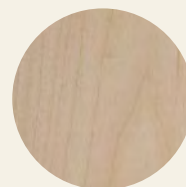

Canadian Maple



Birch



Ash



American Walnut

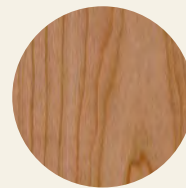

American Cherry



Quarter cut +  
half crown cut



Random matched



Quarter cut  
slip matched



Quarter cut  
book matched

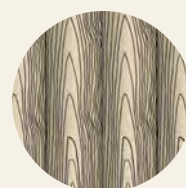

Crown cut  
slip matched

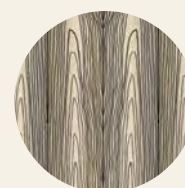

Crown cut  
book matched

Advantage: uniform impression for whole project

Disadvantage: not uniform impression for whole project

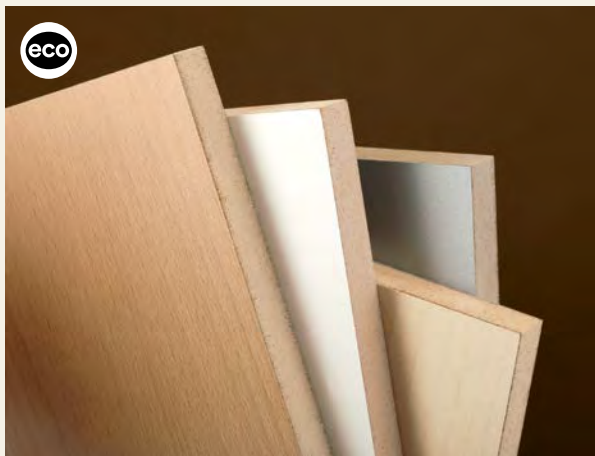

## Surfaces with melamine coating (eco)

- 12 different decors
- All panels glued without formaldehyde
- Short delivery times as all decors are in stock at Topakustik
- Both fire categories D-s2,d0 and B-s1,d0
- FSC Mix possible on request (depending on quantity)

### eco plus collection

Further melamine finishes for quantities above 150 m<sup>2</sup> upon request.

**HPL coating:** All standard HPL coatings are possible. Formats must be coordinated.



## basic: 4100 × 2070 mm / 5600 × 2070 mm



Oak  
M3280 NTL



Maple  
M2106 SMA



Beech  
M3247 SMA



Ash  
M3965 NTL



White  
B3002 LP



Silver  
L4068 LP

## extra: 4100 × 2070 mm



Cherry  
M760 SMA



Walnut  
M4462 SMA



Acacia  
M4451 NTL



Oak Rustic  
M6263 NTL



Concrete  
F2204 STU



Oxyde  
F2195 STU

## stone: 5600 × 2070 mm



Using the simulator on our website, you can put together your desired product on screen. Choose your veneer and perforation and see the results immediately.





## Medium density fibreboard (MDF)

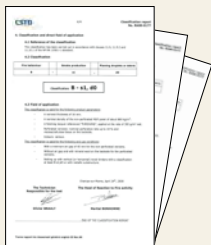

### Fire stability according to Euroclass EN 13501-1

Topakustik products have been tested extensively in accordance with Euroclass EN 13501-1 and are classified as follows in the flame-retardant version: B-s1,d0

All Topakustik products are manufactured from medium density fibreboard (MDF) as standard. Thanks to its homogeneous structure, MDF is ideal for this application. MDF panels are made from soft and hardwood fibres with added binding agents.

Classification table

CH	DIN	EN	US
RF 1	A1	A1-s1,d0	A
RF 1	A2	A2-s1,d0	A
RF 2	B1	B-s1,d0	A
RF 3	B2	D-s2,d0	C

Table serves as a guide only  
DIN is no longer valid

US classifications according to ASTM E84 standard

### This code contains the following values:

- B** Little or no contribution to the spread of fire
- s1** Little or insignificant smoke emission
- d0** No flammable particles or drops in case of fire

### The system is divided into the following categories:

- A1** No contribution to the spread of fire
- A2** No significant contribution to the spread of fire
- B** Little or no contribution to the spread of fire
- C** Limited contribution to the spread of fire
- D** Contribution to the spread of fire
- E** Strong contribution to the spread of fire



To the core materials



### Expansion and contraction of the core panels

Wooden materials are hygroscopic and have a balancing effect on the indoor climate in the event of changing room humidity. However, this also causes the wood materials to shrink and swell.

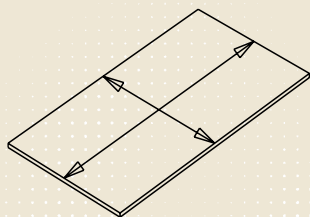

In air-conditioned rooms, a material expansion of 1 mm per metre is to be expected, and in rooms without air conditioning an expansion of 2 mm per metre is possible! Topakustik Classic, Topakustik Perfo, Topakustik Micro and Topakustik Custom should therefore be separated with joints of 3 to 6 mm depending on their size.

**Acclimatisation:** Installation must be carried out in a room climate that is as close as expected to that of the rooms used. The elements must be acclimatised for 3 to 4 days before installation. Ensure that all elements are exposed evenly to the room air. For more detailed information, please refer to the “Topakustik Guidelines” in the installation manual.

### Formaldehyde content

We only use class E05 panels or those that are glued without the addition of formaldehyde. An overview of the panels used is provided here.

Finish	Glued without formaldehyde	Class E05
Real wood veneer	On request	Standard
White or coloured paint	Standard	For special formats
eco (melamine finish)	Standard	For special formats



Topakustik products with formaldehyde-free glued MDF panels were tested for volatile pollutants in accordance with ISO 1600 and awarded the best possible classification (A+).





## Special core panels

# RESA<sup>1</sup>P<sup>®</sup>

RESAP<sup>®</sup> is a fireproof expansion and acoustic panel. The product was developed in response to the greatly increased requirements for fire protection in indoor spaces. RESAP<sup>®</sup> is made from natural gypsum and recycled cellulose fibres and is non-combustible. Particularly striking are its good workmanship and versatility, especially when used as a ceiling and wall finish with acoustic function.

RESAP<sup>®</sup> has the fire protection category A2 (CH: 6.3) and is therefore non-combustible in accordance with EN 13501-1. The product therefore meets all the requirements for modern and safe interior finishes.



### Coloured or white painted finishes:

Homogeneous structure = surface and edges can be painted without edge coating. The RESAP<sup>®</sup>-Plus version is recommended for a largely non-porous paint finish.



### Veneered finishes:

The light brown / beige colouring of the panel is visible in the grooves or perforations and, together with the veneer, gives a high-quality appearance.



To the fireproof expansion  
and acoustic panels

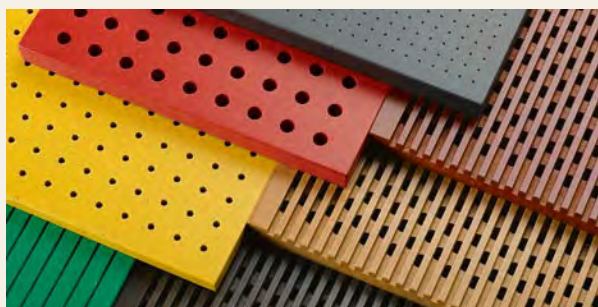

**!** **Core panels, natural coating:**  
 All core panels are industrially manufactured. Colour differences, even within one production batch, cannot be avoided. Applying a top coat can accentuate these differences.

**Coloured core panels**

Black or coloured core panels offer many interesting possibilities on elements from all Topakustik product lines. An excessively strong light-dark contrast (e.g. maple on black MDF) is not recommended for wall finishes – risk of flickering / moiré patterns.

Material name	Fire category DIN (CH)	Suitability for wet rooms				Basic formats: please note the maximum formats	Expansion in air-conditioned rooms, 19 to 23° C, 40 % to 50 % relative humidity
<b>RESAP®</b>	A1 (RF 1) EN A1-s1,d0	-	+	+	-	3100 x 1260 2560 x 1260	0.4 mm / 1m = 0.4 %
<b>3-layer ARIA</b>	B2 (RF 3)	~	-	~	-	Page 90 / 91	
<b>Cement chip</b>	A2 (RF 1)	+	-	⊗	-	2600 / 3100 x 1250	0.8 mm / 1m = 0.8 %
<b>Chip</b>	B2 (RF 3)	-	⊗	⊗	⊗	DIV	0.8 mm / 1m = 0.8 %
<b>Coarse OSB</b>	B2 (RF 3)	~	-	⊗	-	DIV	0.8 mm / 1m = 0.8 %
<b>Forex</b>	B1 (RF 2)	+	-	⊗	-	3050 x 1220	
<b>Plywood</b>	B2 (RF 3)	~	+	⊗	-	DIV	0.8 mm / 1m = 0.8 %

**Key:**  
 + well suited  
 ~ suitable to a limited extent, note the colour differences on blank panels  
 - unsuited  
 ⊗ upon request  
 DIV various other formats, please enquire

**Notes:**

- Paint, page 73**
- Real wood veneer, page 74**
- Melamine coating, page 75**

**!** Topakustik products can also be manufactured from other commonly used core panels. These can be divided up according to the following requirements:

- Behaviour in fire
- Appearance, e.g. special surface or panel design
- Special properties with regard to stability or moisture



## Edges

### Topakustik planks, edge details

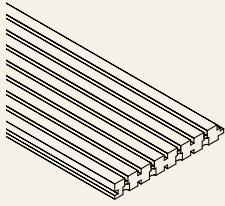

Depending on the length, the planks are manufactured in multiple lengths, i.e. the perforation is visible on the leading edge. Transverse edges with industrial cut. Longitudinal edges with tongue-and-groove connection on request with groove for fastening with turning clips.

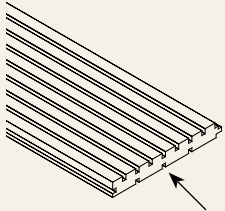

Perforation on the transverse edges are set back on request. The relief grooves on the rear are system-specific and always visible.

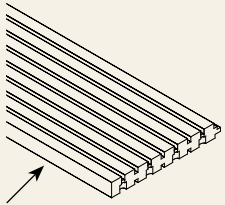

If requested, the first and last plank may have a visible edge without tongue or groove.

### Topakustik panels, edge details

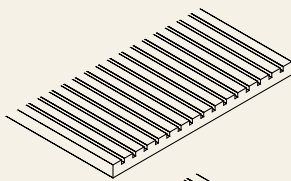

Visible edge, perforation set back (edge painted in coloured paint version!)

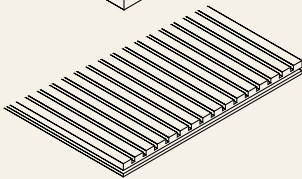

Tongue-and-groove connection, joint 4 mm

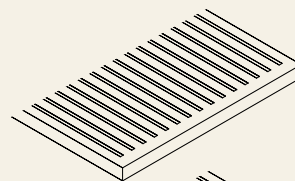

Groove interrupted at edge

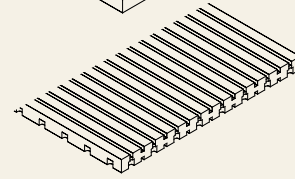

Blind edges with cut perforation

### Production tolerances



**Planks:** Topakustik planks are supplied with an industrial cut as standard. The longitudinal tolerance is  $\pm 2$  mm. On request, the planks can be re-cut to fixed dimensions in the factory (tolerance  $\pm 0.25$  mm per  $m^1$  – this is only recommended for plank lengths of up to approx. 1.5 m (see information on expansion on page 77)).

**Panels:** Topakustik panels are manufactured to exact dimensions in the factory on computer-controlled systems (tolerance  $\pm 0.5$  mm per  $m^1$ ).

Topakustik elements are delivered with the (small) dimensional tolerances listed above. Due to the grooving and perforation of the Topakustik elements, the surface area is increased by a factor of two to three, depending on the type. Topakustik products can therefore react very quickly to fluctuating room humidity at the installation site through dimensional changes (see information on expansion on page 77).

## Cutouts



On site or factory cut



Factory cut with interrupted grooves



Lamp insert for planks  
128 / 256 / 384 mm

## Ceiling finishes for planks and panels

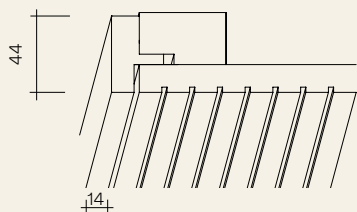

Edge moulding Type 1

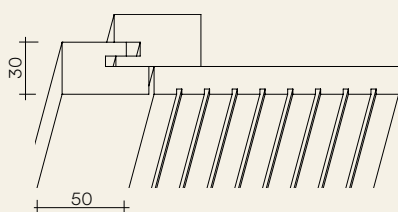

Edge moulding Type 2

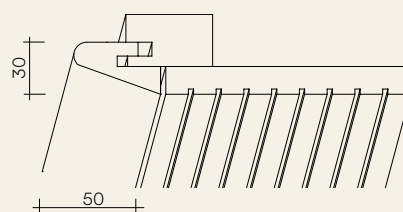

Edge moulding Type 3

## Ceiling finishes for panels

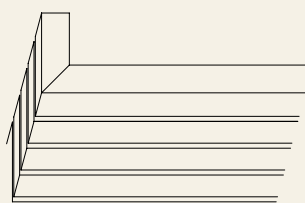

Mitre Type 10

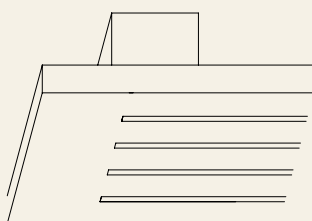

Visible edge with interrupted grooves, Type 11

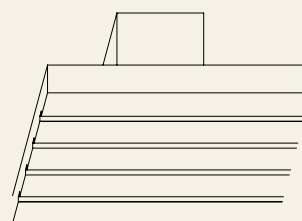

Visible edge with continuous grooves, Type 12

## Wall corners and terminations

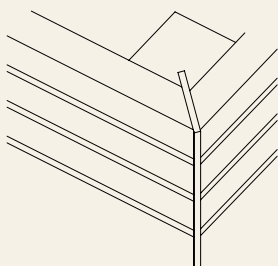

Type 21 (aluminium, natural anodised 35 × 3 mm)

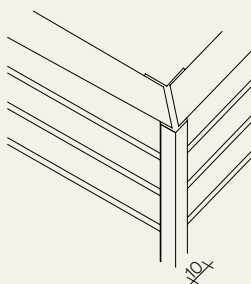

Type 22 (aluminium, natural anodised 10 mm)

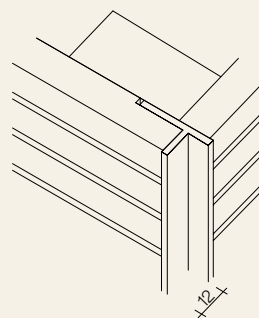

Type 23 (aluminium, natural anodised 12 mm)

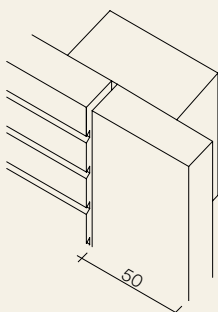

Type 25

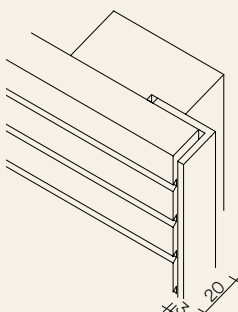

Type 26 (aluminium, natural anodised 30 × 20 × 3 mm)

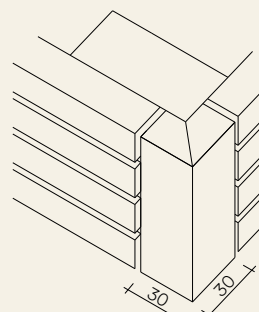

Type 27



## Mounting Topakustik planks

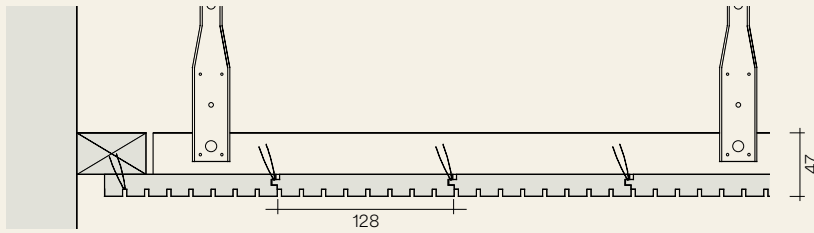

**Mounting on wooden battens:** The Topakustik planks are fixed like conventional tongue-and-groove planks. It is important that the compressed air in the pistol is precisely adjusted so that the clips in the groove do not protrude or penetrate too deeply.

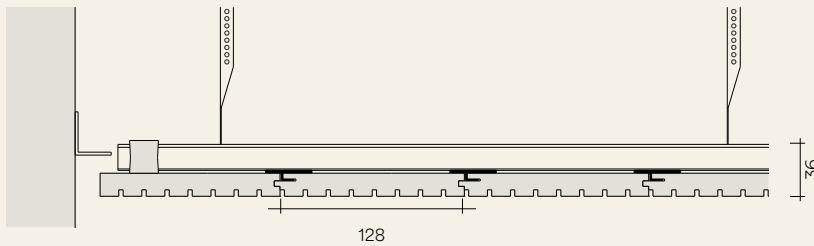
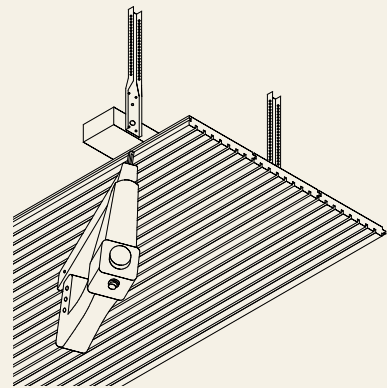

**Installation on metal sub-structures for non-combustible ceilings:** The Topakustik planks are attached to the suspended H-bar using rotary clips. This type of installation is ideal for non-combustible ceiling finishes.

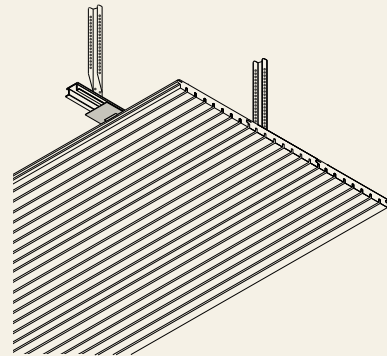

**Narrow grooves (6/2, 8/3, 9/2) are not suitable for installation with rotary clips.**

### Access panel

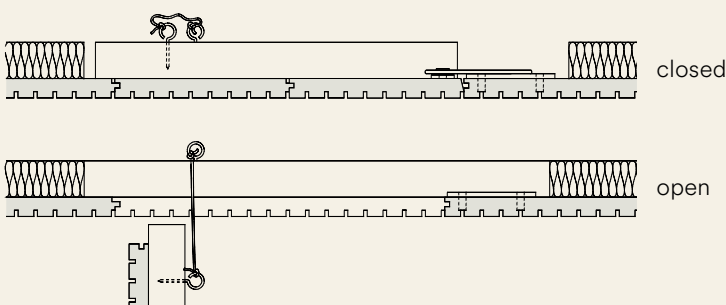

### Layout

Layout types: The installation with offset joints allows for slight material expansion without it becoming visible. In combination with joint widths of about 3 mm, this results in a clear and tidy joint appearance.

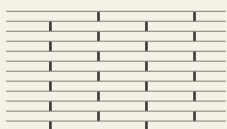

English



Serrated



Random

Planks are manufactured with a precise tongue-and-groove connection, which enables a flat ceiling design. However, individual planks or joints may be visible, in particular if dark colours or shiny paints are used. Planks are installed without expansion joints, which is only possible due to the narrow plank width of only 128 mm. However, installation regulations relating to room climate must be complied with – see page 77.

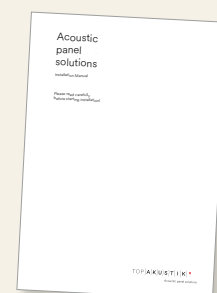

More information can be found in our installation manual.

## Mounting Topakustik panels

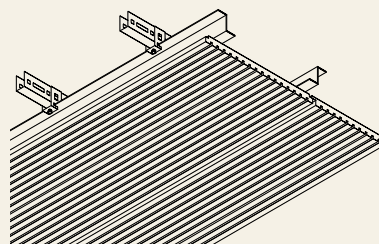
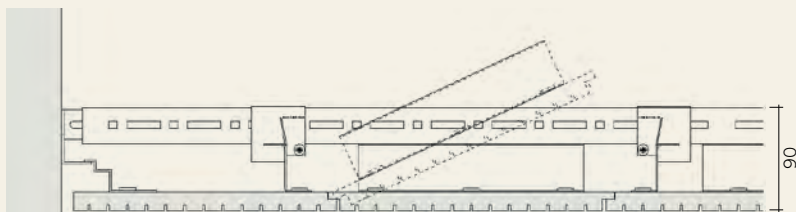

**Z-System:** Every other element is inserted and can be easily removed by lifting.

Recommended planning width = 642 mm

Panel joints = groove + 2 mm (e.g. 14/2 = 2 + 2 = 4 mm joint)

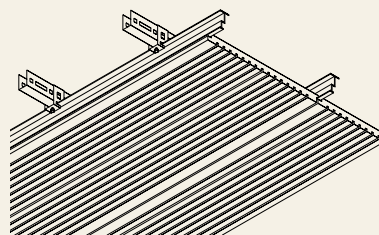
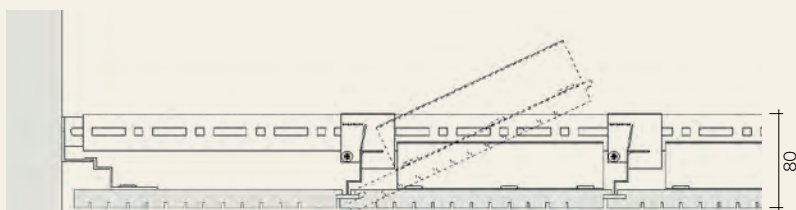

**G-System:** Each element can be easily removed by lifting.

Recommended planning width = 642 mm

Panel joints = groove + 2 mm (e.g. 14/2 = 2 + 2 = 4 mm joint)

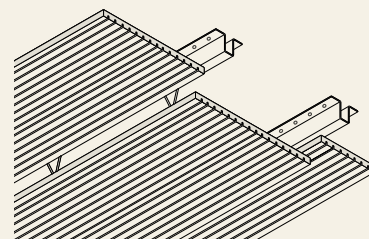
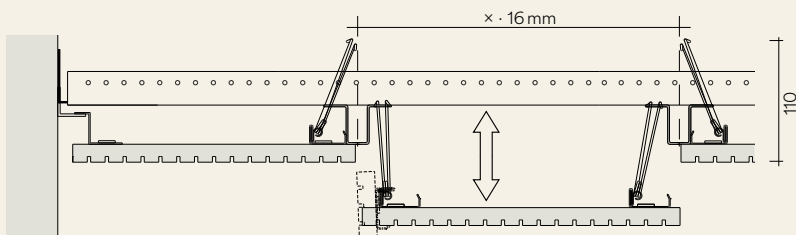

**S11:** Each element is removable. Element width must be divisible by 16 mm.

Recommended planning width = 640 mm (can be divided by 16)

Panel joints = groove + 2 mm (e.g. 14/2 = 2 + 2 = 4 mm joint)

Max. panel length = 2510 mm



**Narrow grooves (6/2, 8/3, 9/2) are not suitable for the Topakustik Grid S11.**



Joint-free ceilings are not possible due to expansion. In addition, the joints serve as a disassembly function and, as a general rule, should be 2 mm wider than the selected groove. For example, for a 2 mm groove (14/2 or 19/2 ...) this means 2 + 2 results in a joint of 4 mm. The installation regulations relating to room climate must be observed at all times – see page 77.

### Layout

Layout types: The installation with offset joints allows for slight material expansion without it becoming visible. In combination with joint widths of about 3 to 6 mm, this results in a clear and tidy joint appearance.



English

Serrated

Parallel  
Not recommended  
for G-System



## Gymnasia

---

Wall and ceiling finishes are subjected to high impacts in gymnasia. In combination with sub-construction systems specially developed for sports venues, Topakustik products optimally meet the high demands in terms of mechanical stress and room acoustics.

Various Topakustik products have been tested and certified in accordance with DIN 18 032, Part 3.

L 4266-III/IV	13/3M, 12 %	Planks in MDF 19 mm
L 4266-IV/IV	28/4M, 7,5 %	Planks in MDF 19 mm
L 4266-I/IV	16/16/8	Panels in MDF 19 mm
L 4266-II/IV	16/16/10-5	Panels in MDF 19 mm
L 4266-I/II	16/16/8	Impact wall (composite)
L 4266-II/II	28/4M	Impact wall (composite)

### Ball impact resistance

Various Topakustik products have been tested and certified for limited ball impact resistance in accordance with DIN 18032-3:2018-11. In this standard, the strength, function and safety of the components must not be impaired after being subjected to stress and must not have changed their appearance excessively.

The tested wall elements survived impacts from a handball without damage.

## Swimming pools

---

For acoustic finishes in wet rooms, requirements corresponding to the application must be met, such as:

- Perfectly constructed ceilings and walls according to code
- Rear ventilation of wall and ceiling finishes
- Use of corrosion-resistant sub-construction materials
- Use of special, moisture-resistant core panels during production
- Use of special paints or impregnations
- Consideration of the (extraordinary) shrinkage and swelling behaviour of the core panels
- Water-repellent absorbers such as polyester fleece

The use of acoustic surfaces in wet rooms is very complex. Please contact us with your project and we will be happy to assist you in developing it.

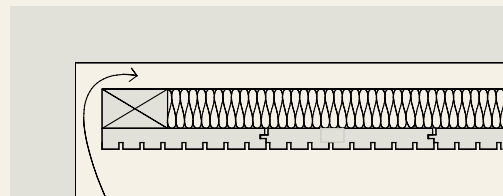



Beacon of Light, GB · Architect: Faulkner Browns Architects, UK  
Photo: Richard Chivers Photography and Films, GB · Product: Topakustik Perfo M



Bäderquartier Baden CH · Architect: Mario Botta, Mendrisio CH  
Photo: Rene Dürr, Zürich CH · Product: Topakustik Special



# Topakustik cabinet fronts

Cabinet fronts or rear walls are ideal for use as sound absorbers. The following products have proven their worth in particular here: Topakustik Classic 14/2, 19/2, Topakustik Perfo T, Topakustik Perfo Clou and Topakustik Micro.



RK doors, inside view

## Type RK

Topakustik Classic	$\alpha$ w	Euro	NRC
<b>RK 9/2 M</b>	0.55	D	0.56
<b>RK 14/2 M</b>	0.60 H	C	0.68

Topakustik	$\alpha$ w	Euro	NRC
<b>RK Clou 8/8/1.2</b>	0.35 LM	D	0.54
<b>RK Micro 2/2/0.5</b>	0.70	C	0.82

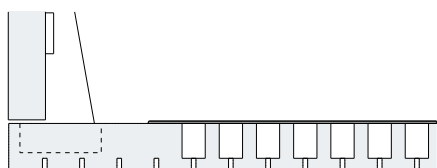

In conjunction with the fleece applied on the inside (RK 280), the acoustic surface ensures very good absorption. The fleece we have developed is tear-resistant and is set back on bores for hinges and locks.



Always use a three-point lock.

## Type Duplex

Topakustik Classic	$\alpha$ w	Euro	NRC
<b>sw* 14/2 M</b>	0.50	D	0.55

sw\* is comparable to Duplex

Topakustik Perfo	$\alpha$ w	Euro	NRC
<b>sw* T 16/16/12-3</b>	0.25 L	E	0.27
<b>sw* Clou 8/8/1.2</b>	0.35 L	D	0.39

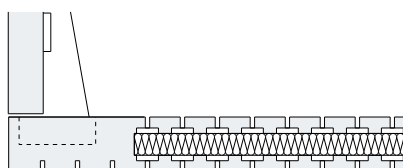

Doors with concealed sound absorbers. Duplex is also suitable for sliding doors. The finish on the rear depends on the type and format.



For revolving doors, always use a three-point lock.



To the product page with  
details and reference objects



SAP office, Graphisoft Park, HUN · Architect: MaciLancos Studio KFT, HUN  
Photo: Bujnovszky Tamás Photography, Budapest HUN · Product: Topakustik Classic with medium-sized and wide grooves, and Topakustik Perfo T

Topakustik Specials





# Topakustik formed shapes

For ceiling sails, curved walls, ceilings, etc. Topakustik elements can be used for shaped wall and ceiling finishes. For narrower radii, flexible planks or panels can be assembled on the rear making them easy to adapt to the sub-construction.



Further information on  
tailor-made solutions

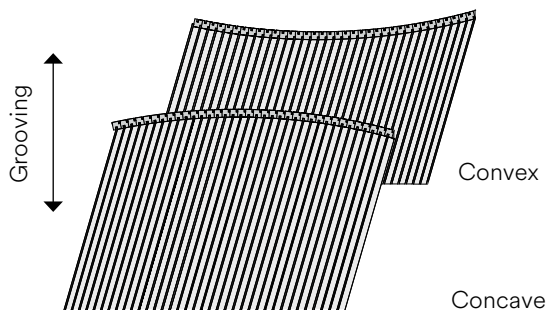

	Radius	Processing
<b>Planks</b>	>10 m	Mounted in segments
	>5 m	Grooved on rear
<b>Panels</b>	>5 m	Grooved on rear
	>1 m	Prepared at the factory as a moulded part

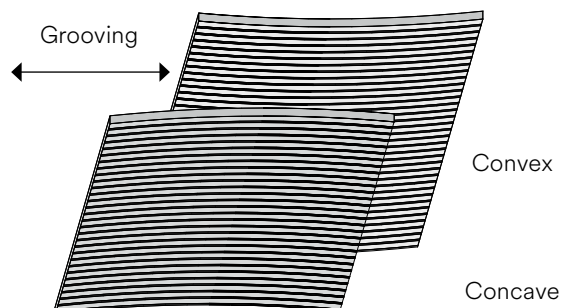

	Radius	Processing
<b>Planks</b>	>15 m	No special machining
	>8 m	Grooved on rear
<b>Panels</b>	>8 m	Grooved on rear
	>1 m	Prepared at the factory as a moulded part



Hong Kong Palace Museum, HK - Architect: Rocco Design Architects Associates Ltd, HK  
Photo: Simon Yau, Andermax (HK) Limited, HK - Product: Topakustik Custom Split



Topakustik Specials



# Topakustik ARIA-Plus

The grooving with the black background gives a perception of depth, making the bars look like individual strips and thus showcasing the individual softwood strips in the best possible way.

ARIA-Plus is available in knotty spruce or finger-jointed white fir.

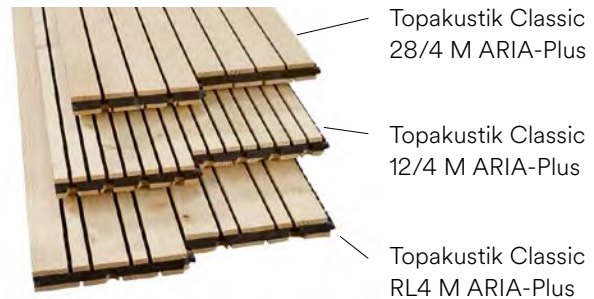

Finger-jointed white fir



Knotty spruce

	Panel size	Planks
Knotty spruce	4080 × 2050 × 20 mm	ideal = 4080 × 128 × 20 mm
Finger-jointed white fir		

### Sound absorption values according to ISO 354

with fleece on rear and mineral wool 30 mm (60 kg/m<sup>3</sup>)

Topakustik Classic	Planks	Panels*	Approx. 216 / 226 mm suspension height			Approx. 56 / 66 mm suspension height		
			α w	Euro	NRC	α w	Euro	NRC
12/4 M	15.0%	X	0.80	B	0.89	0.80 M	B	0.86
28/4 M	7.5%	X	0.55 LM	D	0.78	0.55 M	D	0.72
RL3 M	7.4%	X	0.80 LM	B	0.79	0.75	C	0.82
RL4 M	9.4%	X	0.80	B	0.82	0.80	B	0.85

\* Panels can only be manufactured for absolutely symmetrical products (stability)



To the core materials



New wine cellar, WeinSTAMM, Thayngen CH · Architect: Wunderli Planung GmbH, Thayngen CH · Photo: K. Klemenz, Dubach.digital  
Product: Topakustik Classic, medium-sized grooves

# Topakustik ARIA-Pure

ARIA-Pure means white fir through and through! We have the finger-jointed three-layer white fir panel available in our warehouse in two formats with a thickness of 16 mm.

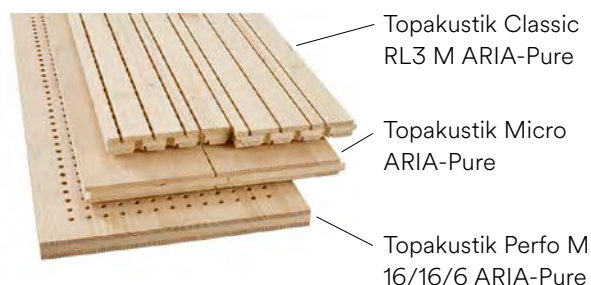

	Panel size	Planks	Panels
<b>Finger-jointed white fir</b>	4080 × 2050 mm	ideal = 4080 × 128 mm	ideal = 2020 × 640 mm
	5000 × 2050 mm	ideal = 2480 × 128 mm	ideal = 2490 × 640 mm

### Sound absorption values according to ISO 354

with fleece on rear and mineral wool 30 mm (60 kg/m<sup>3</sup>)



Topakustik Classic  
18.5/2.5 M with 3D surface  
Length of 2300 or 3900 mm  
possible

Topakustik	Planks	Panels*	Approx. 216 / 226 / 246 mm suspension height			Approx. 46 / 56 / 96 mm suspension height		
			α w	Euro	NRC	α w	Euro	NRC
<b>Classic 12/4 M</b>	15.0%	X	0.80	B	0.89	0.80 M	B	0.86
<b>Classic 28/4 M</b>	7.5%	X	0.55 LM	D	0.78	0.55 M	D	0.72
<b>Classic RL3 M</b>	7.4%	X	0.80 LM	B	0.79	0.75	C	0.82
<b>Classic RL4 M</b>	9.4%	X	0.80	B	0.82	0.80	B	0.85
<b>Classic 13.5/2.5 M</b>	9.5%	X	0.90	A	0.88	0.85	B	0.84
<b>Classic 18.5/2.5 M 3D</b>	7.3%	X	0.80	B	0.83	0.75 M	C	0.82
<b>Micro 2/2/0.5</b>		X	0.60 LM	C	0.76	0.60 LM	C	0.81
<b>Micro 1.8/1.8/0.5</b>		X	0.65 L	C	0.80	0.65 LM	C	0.84
<b>Perfo M 16/16/6</b>	12.0%	X	0.50 LM	D	0.79	0.50 M	D	0.73
<b>Perfo M 16/16/8</b>	20.0%	X	0.75 LM	C	0.91	0.70 M	C	0.81
<b>Perfo M 16/16/10</b>	30.0%	X	0.95	A	0.95	0.90	A	0.90

\* Panels can only be manufactured for absolutely symmetrical products (stability)



To the core materials



# Topakustik Service

Quality is never a coincidence. What we do, we do perfectly – to the highest quality for our customers, with respect for the environment, with products that comply with EN standards and with global patent protection for our inventions.

TOP(A)K(U)S(T)I(K) 

Acoustic panel solutions

RESA<sup>1</sup>P<sup>®</sup>

are registered trademarks of Topakustik AG

EN 13501-1 <b>Fire classification</b>	EN 20354 <b>Sound absorption</b>	CH <b>PATENT</b> No 683 112
EN 13986 <b>Wood materials</b>	US <b>PATENT</b> No 5, 362, 931 No 5, 422, 446	EU <b>PATENT</b> No 0504629

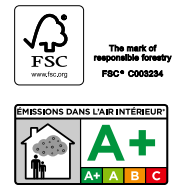

FSC products are marked

Cholhuttli Forest, Lungern



## Sample boxes and individual samples

---



**Deluxe sample box**  
(subject to a nominal charge)



**Basic sample box**  
**Eco sample box**  
**ARIA sample box**

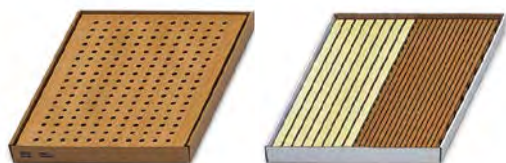

### A5 samples in stock

... more than 250 different samples available immediately from our warehouse! Special samples within 2 to 3 weeks + shipping (nominal charge)

## Installation manual

---

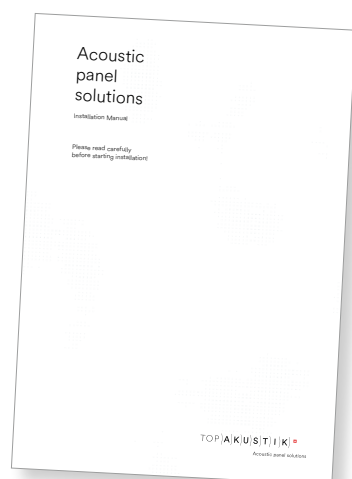

### Topakustik installation manual

with sub-constructions, guidelines and tips for the tried-and-tested Topakustik mounting systems. Please do not hesitate to contact us for special assembly solutions.



# Topakustik product names

New	Previously
<b>Topakustik Classic</b>	
Topakustik Classic 6/2 M or T	TOPAKUSTIK 6/2 M or T
Topakustik Classic 8/3 M	TOPAKUSTIK 8/3 M
Topakustik Classic 9/2 M	TOPAKUSTIK 9/2 M
Topakustik Classic 12/4 M	TOPAKUSTIK 12/4 M
Topakustik Classic 13/3 M or T	TOPAKUSTIK 13/3 M or T
Topakustik Classic 14/2 M	TOPAKUSTIK 14/2 M
Topakustik Classic 18/3 M & 19/2 M	TOPAKUSTIK 18/3 M & 19/2 M
Topakustik Classic 18.5/2.5 M 3D	TOPAKUSTIK 18.5/2.5 M 3D
Topakustik Classic 18.5/2.5 M	TOPAKUSTIK 18.5/2.5 M
Topakustik Classic 28/4 M or T	TOPAKUSTIK 28/4 M or T
Topakustik Classic 29/3 M & 30/2 M	TOPAKUSTIK 29/3 M & 30/2 M
Topakustik Classic RL2 M-Solo	TOPAKUSTIK-R, R planks
Topakustik Classic RL3 M-Solo	TOPAKUSTIK-R, R planks
Topakustik Classic RL4 M-Solo	TOPAKUSTIK-R, R planks
Topakustik Classic RL2 M-Duo	TOPAKUSTIK-R, R planks
Topakustik Classic RL3 M-Duo	TOPAKUSTIK-R, R planks
Topakustik Classic RL4 M-Duo	TOPAKUSTIK-R, R planks
Topakustik Classic RL2 M-Trio	TOPAKUSTIK-R, R planks
Topakustik Classic RL3 M-Trio	TOPAKUSTIK-R, R planks
Topakustik Classic RL4 M-Trio	TOPAKUSTIK-R, R planks
Topakustik Classic RP2 M	TOPAKUSTIK-R, R panels
Topakustik Classic RP3 M	TOPAKUSTIK-R, R panels
Topakustik Classic RP4 M	TOPAKUSTIK-R, R panels
Topakustik Classic HR 9/2 M	TOPAKUSTIK HR 9/2 M
Topakustik Classic 60/4 M	TOPAKUSTIK 60/4 M
Topakustik Classic 61/3 M	TOPAKUSTIK 61/3 M
Topakustik Classic 93/3 M	TOPAKUSTIK 93/3 M
Topakustik Classic ARIA-Plus	TOPAKUSTIK ARIA-PLUS
Topakustik Classic ARIA-Pure	TOPAKUSTIK and TOPPERFO ARIA-PURE
<b>Topakustik Perfo</b>	
Topakustik Perfo M 10.66/10.66/6	TOPPERFO-M 10.66/10.66/6
Topakustik Perfo M 10.66/10.66/8	TOPPERFO-M 10.66/10.66/8
Topakustik Perfo M 16/8/6	TOPPERFO-M 16/8/6
Topakustik Perfo M 16/8/8	TOPPERFO-M 16/8/8
Topakustik Perfo M 16/16/6	TOPPERFO-M 16/16/6
Topakustik Perfo M 16/16/8	TOPPERFO-M 16/16/8
Topakustik Perfo M 16/16/10	TOPPERFO-M 16/16/10
Topakustik Perfo M 20/20/6	TOPPERFO-M 20/20/6
Topakustik Perfo M 20/20/10	TOPPERFO-M 20/20/10
Topakustik Perfo M 32/8/6	TOPPERFO-M 32/8/6
Topakustik Perfo M 32/8/8	TOPPERFO-M 32/8/8
Topakustik Perfo M 32/8/10	TOPPERFO-M 32/8/10
Topakustik Perfo M 32/16/6	TOPPERFO-M 32/16/6
Topakustik Perfo M 32/16/8	TOPPERFO-M 32/16/8
Topakustik Perfo M 32/32/6	TOPPERFO-M 32/32/6
Topakustik Perfo M 32/32/8	TOPPERFO-M 32/32/8
Topakustik Perfo M 32/32/10	TOPPERFO-M 32/32/10
Topakustik Perfo M 40/40/8	TOPPERFO-M 40/40/8
Topakustik Perfo M 40/40/10	TOPPERFO-M 40/40/10

New	Previously
Topakustik Perfo M 60/60/8	TOPPERFO-M 60/60/8
Topakustik Perfo T 16/16/10-2	TOPPERFO-T 16/16/10-2
Topakustik Perfo T 16/16/10-3	TOPPERFO-T 16/16/10-3
Topakustik Perfo T 16/16/10-4	TOPPERFO-T 16/16/10-4
Topakustik Perfo T 16/16/10-5	TOPPERFO-T 16/16/10-5
Topakustik Perfo T 20/20/12-3	TOPPERFO-T 20/20/12-3
Topakustik Perfo T 32/32/10-3	TOPPERFO-T 32/32/10-3
Topakustik Perfo T 32/32/10-4	TOPPERFO-T 32/32/10-4
Topakustik Perfo T 32/32/10-5	TOPPERFO-T 32/32/10-5
Topakustik Perfo Clou 4/4/1.2	TOPPERFO-Clou 4/4/1.2
Topakustik Perfo Clou 5.33/5.33/1.2	TOPPERFO-Clou 5.33/5.33/1.2
Topakustik Perfo Clou 5.33/5.33/1.6	TOPPERFO-Clou 5.33/5.33/1.6
Topakustik Perfo Clou 5.33/5.33/2	TOPPERFO-Clou 5.33/5.33/2
Topakustik Perfo Clou 6.4/6.4/1.2	TOPPERFO-Clou 6.4/6.4/1.2
Topakustik Perfo Clou 6.4/6.4/1.6	TOPPERFO-Clou 6.4/6.4/1.6
Topakustik Perfo Clou 6.4/6.4/2	TOPPERFO-Clou 6.4/6.4/2
Topakustik Perfo Clou 8/8/1.2	TOPPERFO-Clou 8/8/1.2
Topakustik Perfo Clou 8/8/1.6	TOPPERFO-Clou 8/8/1.6
Topakustik Perfo Clou 8/8/2	TOPPERFO-Clou 8/8/2
Topakustik Perfo Clou 8/8/3	TOPPERFO-Clou 8/8/3
<b>Topakustik Micro</b>	
Topakustik Micro 1.33/1.33/0.5	TOPPERFO-Micro 1.33/1.33/0.5
Topakustik Micro 1.8/1.8/0.5	TOPPERFO-Micro 1.8/1.8/0.5
Topakustik Micro 2/2/0.3	TOPPERFO-Micro 2/2/0.3
Topakustik Micro 2/2/0.5	TOPPERFO-Micro 2/2/0.5
Topakustik Micro 2.5/2.5/0.5	TOPPERFO-Micro 2.5/2.5/0.5
Topakustik Micro 3/3/0.5	TOPPERFO-Micro 3/3/0.5
<b>Topakustik Custom</b>	
Topakustik Custom Bubble 2.0	TOPPERFO-Bubble 2.0
Topakustik Custom Bubble 3.0	TOPPERFO-Bubble 3.0
Topakustik Custom Split	TOPPERFO Split
Topakustik Custom Linear	TOPPERFO Linear
Topakustik Custom Graphic Rain	TOPPERFO Graphic Rain
Topakustik Custom Graphic Fragmental	TOPPERFO Graphic Fragmental
Topakustik Custom Graphic Leaf	TOPPERFO Graphic Leaf
Topakustik Custom Line 2110	TOPAKUSTIK LINE 2110
Topakustik Custom Line 2111	TOPAKUSTIK LINE 2111
Topakustik Custom Line 2112	TOPAKUSTIK LINE 2112
Topakustik Custom Line 2113	TOPAKUSTIK LINE 2113
Topakustik Custom Line 2114	TOPAKUSTIK LINE 2114
Topakustik Custom Line 2115	TOPAKUSTIK LINE 2115
Topakustik Custom Line 2116	TOPAKUSTIK LINE 2116
Topakustik Custom Line 2117	TOPAKUSTIK LINE 2117
Topakustik Custom Line 2118	TOPAKUSTIK LINE 2118
Topakustik Custom Line 2119	TOPAKUSTIK LINE 2119
Topakustik Custom Line 2120	TOPAKUSTIK LINE 2120
Topakustik Custom Line 2121	TOPAKUSTIK LINE 2121
Topakustik Custom Line 2122	TOPAKUSTIK LINE 2122
Topakustik Custom Line 2123	TOPAKUSTIK LINE 2123
Topakustik Custom Line 2124	TOPAKUSTIK LINE 2124

# Topakustik

## contact information

Thanks to our global sales network, we can always be reached wherever you are.

Contact details for our international sales partners:  
[www.topakustik.ch](http://www.topakustik.ch)

### Head office

---

Topakustik AG  
Obseestrasse 11  
6078 Lungern  
Switzerland

[contact@topakustik.ch](mailto:contact@topakustik.ch)  
[www.topakustik.ch](http://www.topakustik.ch)  
T +41 41 679 73 73

### Presented by

---



2022 edition  
Subject to change without prior notice  
© Topakustik  
Printed in Switzerland on FSC Mix paper



View from the Brüning Pass over Lungern to Kaiserstuhl



